

## Silicon Temperature Sensors

KT 100	KTY 10-x
KT 110	KTY 11-x
KT 130	KTY 13-x
KT 210	KTY 21-x
KT 230	KTY 23-x
KTY 16-6	KTY 19-6

### Features

- Temperature dependent resistor with positive temperature coefficient
- Temperature range – 50 °C to + 150 °C (– 60 F to 300 F)
- Available in SMD or leaded or customized packages
- Linear output
- Excellent longterm stability
- Polarity independent due to symmetrical construction
- Fast response time
- Resistance tolerances ( $R_{25}$ ) of  $\pm 3\%$  or  $\pm 1\%$

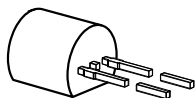

**Modified TO-92**

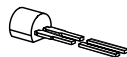

**TO-92 Mini**

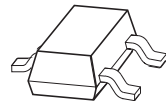

**SOT-23**

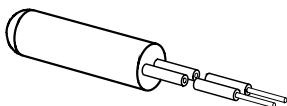

**KTY 16-6**

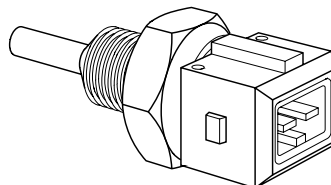

**KTY 19-6**

**Standard Packages**

Type	Marking	Ordering Code	$R_{25 \text{ min}}$	$R_{25 \text{ max}}$	Package
			(in $\Omega$ with $I_{\text{op}} = 1 \text{ mA}$ )		
KT 100	KT 100	Q62705-K331	1940	2060	TO-92
KT 110	T1	Q62705-K332	1940	2060	TO-92 Mini
KT 130	T1	Q62705-K333	1940	2060	SOT-23 <sup>1)</sup>
KT 210	N1	Q62705-K334	970	1030	TO-92 Mini
KT 230	N1	Q62705-K335	970	1030	SOT-23 <sup>1)</sup>
KTY 10-5	KTY 10-5	Q62705-K110	1950	1990	TO-92
KTY 10-6	KTY 10-6	Q62705-K132	1980	2020	TO-92
KTY 10-62	KTY 10-62	Q62705-K71	1990	2010	TO-92
KTY 10-7	KTY 10-7	Q62705-K111	2010	2050	TO-92
KTY 11-5	T5	Q62705-K245	1950	1990	TO-92 Mini
KTY 11-6	T6	Q62705-K246	1980	2020	TO-92 Mini
KTY 11-7	T7	Q62705-K247	2010	2050	TO-92 Mini
KTY 13-5	T5	Q62705-K249	1950	1990	SOT-23 <sup>1)</sup>
KTY 13-6	T6	Q62705-K250	1980	2020	SOT-23 <sup>1)</sup>
KTY 13-7	T7	Q62705-K251	2010	2050	SOT-23 <sup>1)</sup>
KTY 21-5	N5	Q62705-K258	975	995	TO-92 Mini
KTY 21-6	N6	Q62705-K259	990	1010	TO-92 Mini
KTY 21-7	N7	Q62705-K260	1005	1025	TO-92 Mini
KTY 23-5	N5	Q62705-K262	975	995	SOT-23 <sup>1)</sup>
KTY 23-6	N6	Q62705-K263	990	1010	SOT-23 <sup>1)</sup>
KTY 23-7	N7	Q62705-K264	1005	1025	SOT-23 <sup>1)</sup>

**Custom Packages**

Type	Marking	Ordering Code	$R_{25 \text{ min}}$	$R_{25 \text{ max}}$	Screw Thread
			(in $\Omega$ with $I_{\text{op}} = 1 \text{ mA}$ )		
KTY 16-6	none	Q62705-K128	1980	2020	–
KTY 19-6M	KTY 19M	Q62705-K271	1980	2020	ISO M10x1
KTY 19-6Z	KTY 19Z	Q62705-K272	1980	2020	NPTF 1/8x27
Connector set for KTY 19		Q62901-B80			

<sup>1)</sup> Electrical contact between Pin1 and Pin2 (refer to package outlines drawing).

## Absolute Maximum Ratings

Parameter	Symbol	KT 1x0 KTY 1x-x	KT 2x0 KTY 2x-x	Unit
Maximum operating voltage <sup>1)</sup> $T_A \leq 25\text{ °C}, t \leq 10\text{ ms}$	$V_{opmax}$	25		V
Maximum operating current	$I_{opmax}$	5	7	mA
Peak operating current $T_A \leq 25\text{ °C}, t \leq 10\text{ ms}$	$I_{opp}$	7	10	mA
Operating temperature range	$T_{op}$	- 50 ... + 150		°C
Storage temperature range	$T_{stg}$	- 50 ... + 150		°C

<sup>1)</sup> When the temperature sensor is operated with long supply leads, it should be protected through the parallel connection of a > 10 nF capacitor to prevent damage to the sensor through induced voltage peaks.

## Electrical Characteristics

$$I_{op} = 1\text{ mA}$$

Thermal Time Constant ( $\tau$ ); (63% of $\Delta T$ )	$\tau_{air}$ (typ.)	$\tau_{oil}$ (typ.)	Unit
KT 100, KTY 10-x	40	4	s
KT 110, KT 210, KTY 11-x, KTY 21-x	11	1.5	
KT 130, KT 230, KTY 13-x, KTY 23-x	7	1	
KTY 16-6	40	4	
KTY 19-6M/Z	40	4	

## General Technical Data: KT- and KTY-Series Temperature Sensors

These temperature sensors are designed for the measurement, control and regulation of air, gases and liquids within the temperature range of  $-50\text{ °C}$  to  $+150\text{ °C}$ . The temperature sensing element is an n-conducting silicon crystal in planar technology. The gentle curvature of the characteristic,  $R_T = f(T_A)$ , is described as a regression parabola in the following expressions.

The resistance of the sensor can be calculated for various temperatures from the following second order equation, valid over the temperature range  $-30\text{ °C}$  to  $+130\text{ °C}$ .

$$R_T = R_{25} \times (1 + \alpha \times \Delta T_A + \beta \times \Delta T_A^2) = f(T_A)$$

$$\text{with: } \alpha = 7.88 \cdot 10^{-3} \text{ K}^{-1}; \beta = 1.937 \cdot 10^{-5} \text{ K}^{-2}$$

The temperature factor  $k_T$  can be derived from this:

$$k_T = \frac{R_T}{R_{25}} = 1 + \alpha \times \Delta T_A + \beta \times \Delta T_A^2 = f(T_A)$$

The temperature at the sensor can be calculated from the change in the sensors resistance from the following equation, which approximates the characteristic curve.

$$T = \left( 25 + \frac{\sqrt{\alpha^2 - 4 \times \beta + 4 \times \beta \times k_T} - \alpha}{2 \times \beta} \right) \text{°C}$$

**Table 1**  
**Spread of the Temperature Factor  $k_T$**

$T_A$ °C	$k_T$		
	min.	typ.	max.
- 50	0.506	0.518	0.530
- 40	0.559	0.570	0.581
- 30	0.615	0.625	0.635
- 20	0.676	0.685	0.694
- 10	0.741	0.748	0.755
0	0.810	0.815	0.821
10	0.883	0.886	0.890
20	0.960	0.961	0.962
25	1.0 <sup>1)</sup>		
30	1.039	1.040	1.041
40	1.119	1.123	1.126
50	1.204	1.209	1.215
60	1.291	1.300	1.308
70	1.383	1.394	1.405
80	1.478	1.492	1.506
90	1.577	1.594	1.611
100	1.680	1.700	1.720
110	1.786	1.810	1.833
120	1.896	1.923	1.951
130	2.010	2.041	2.072
140	2.093	2.128	2.163
150	2.196	2.235	2.274

1) Normalising point

**Sensor Resistance  $R_T = k_T \times R_{25} = f(T_A)$**

$I_B = 1 \text{ mA}$ ; Example:  $R_{25} = 2000 \text{ } \Omega$

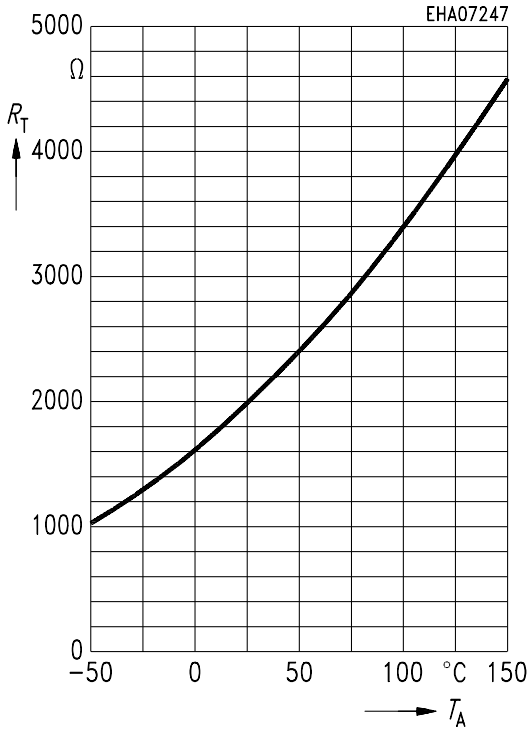

**Sensor Resistance  $R_T = k_T \times R_{25} = f(T_A)$**

$I_B = 1 \text{ mA}$ ; Example:  $R_{25} = 1000 \text{ } \Omega$

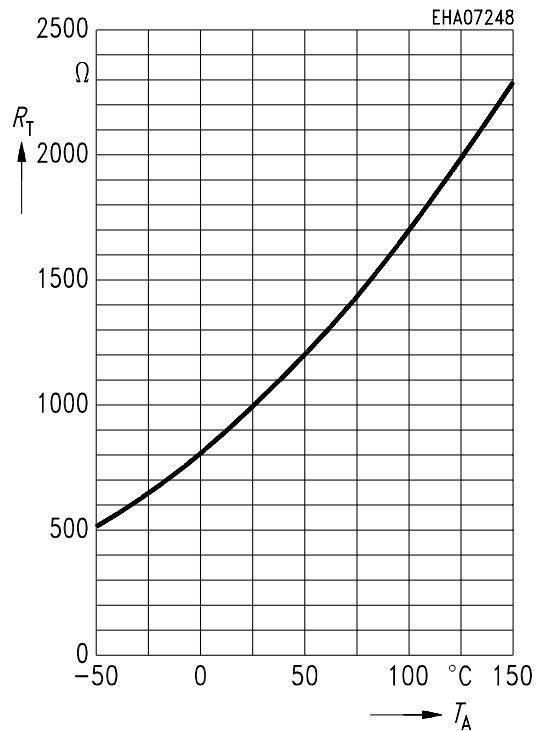

**Typical Dependence of Sensor Resistance on Supply Current**

Example: KTY 10-6 in oil at  $T_A = 25 \text{ } ^\circ\text{C}$

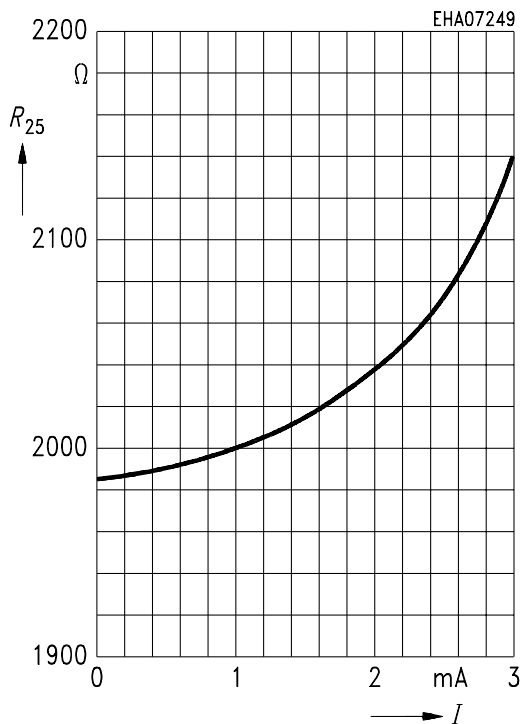

**Typical Dependence of Sensor Resistance on Supply Current**

Example: KTY 21-6 in oil at  $T_A = 25 \text{ } ^\circ\text{C}$

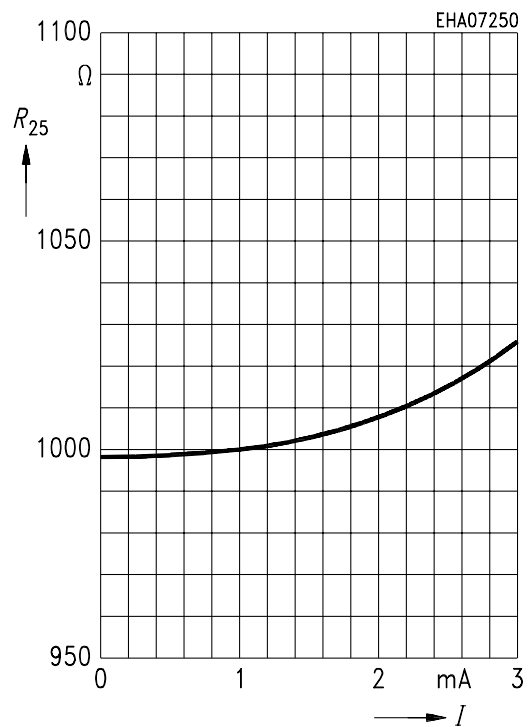

**Typical Deviation of Sensor Resistance from the Basic Resistance  $R_{25}$  ( $I_B = 1\text{mA}$ ) Versus Supply Current**

Example: KTY 10-6 in oil at  $T_A = 25\text{ }^\circ\text{C}$

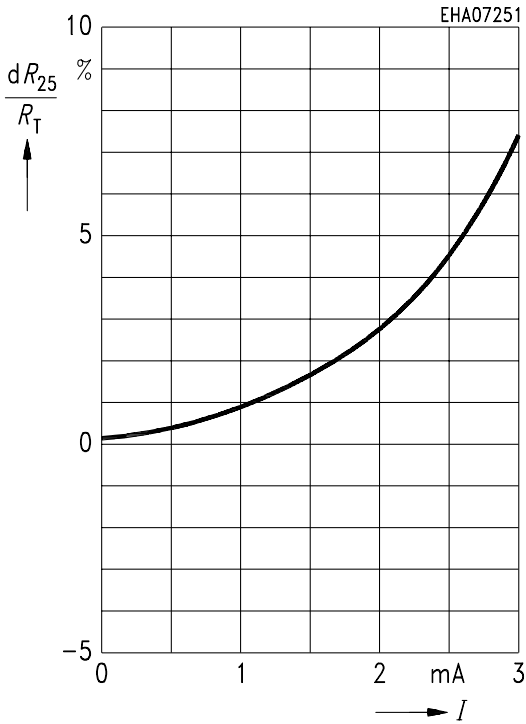

**Typical Deviation of Sensor Resistance from the Basic Resistance  $R_{25}$  ( $I_B = 1\text{mA}$ ) Versus Supply Current**

Example: KTY 21-6 in oil at  $T_A = 25\text{ }^\circ\text{C}$

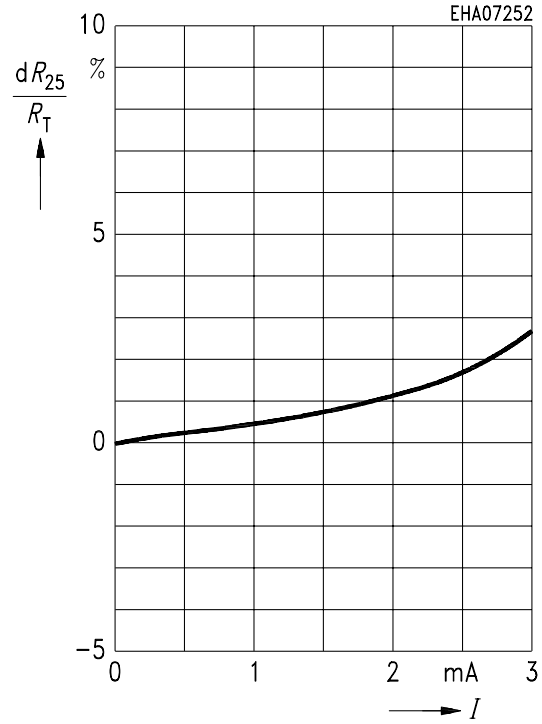

**Typical Relationship of the Temperature Factor**

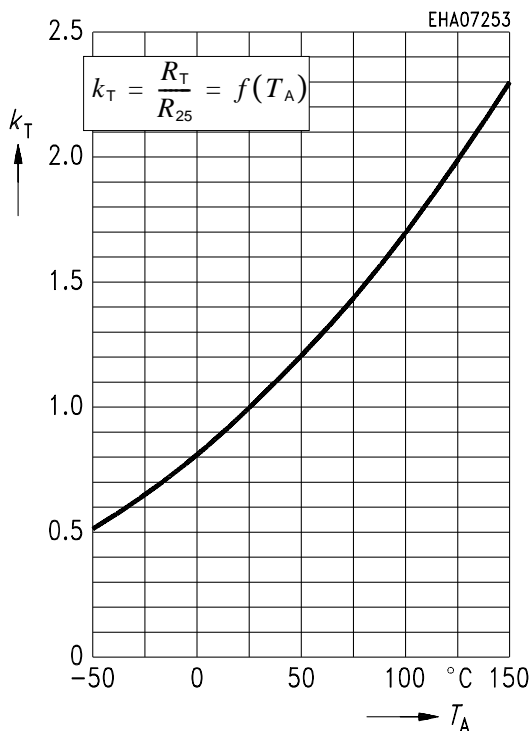

**Typical Relationship of the Temperature Factor**

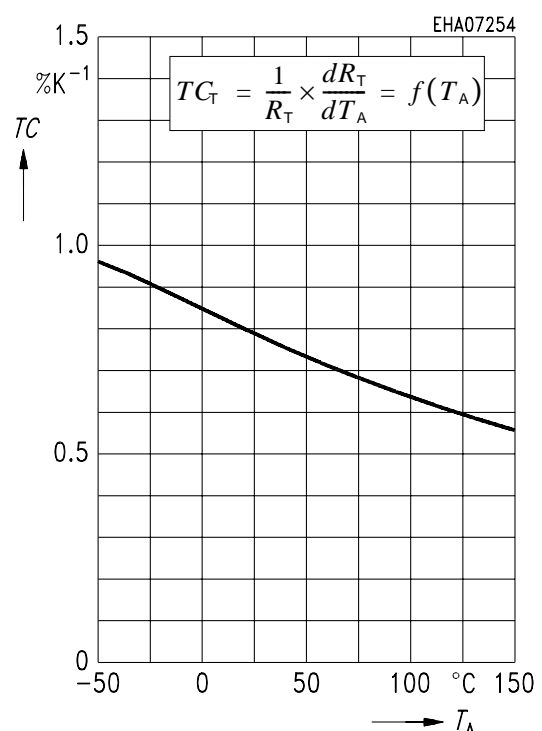

## Definition of the Thermal Time Constant $\tau$

$$\Delta T_A = T_{A2} - T_{A1}; \tau = t_1 - t_0$$

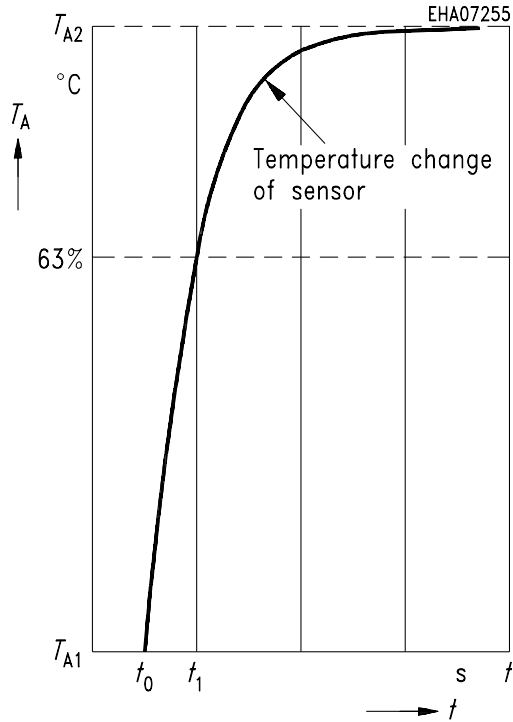

## Thermal Time constant

$$\tau = 5 \text{ s}$$

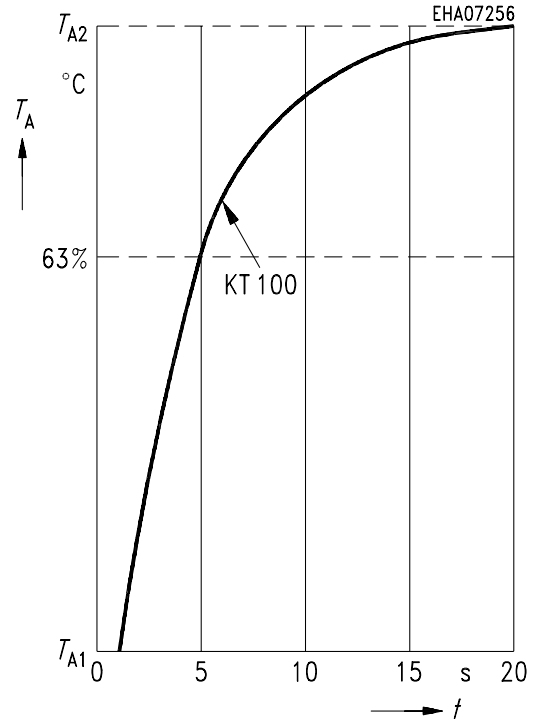

## Peak Current in Air

$$R_{25} = 2000 \Omega; \hat{I} = f(T_A)$$

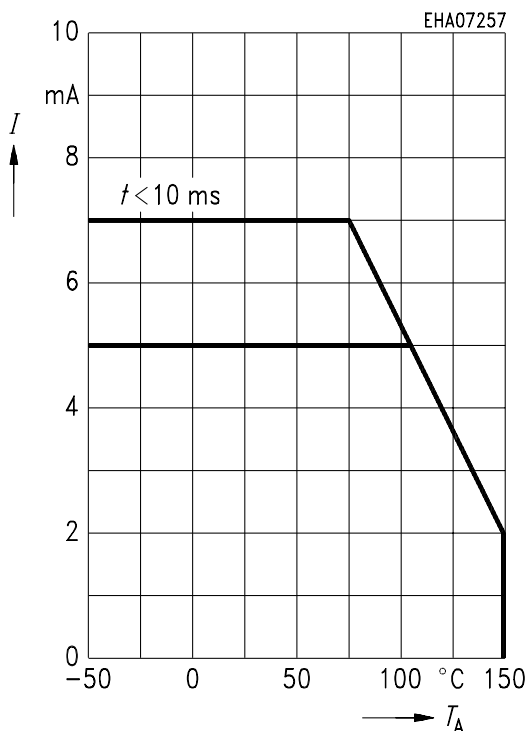

## Peak Current in Air

$$R_{25} = 1000 \Omega; \hat{I} = f(T_A)$$

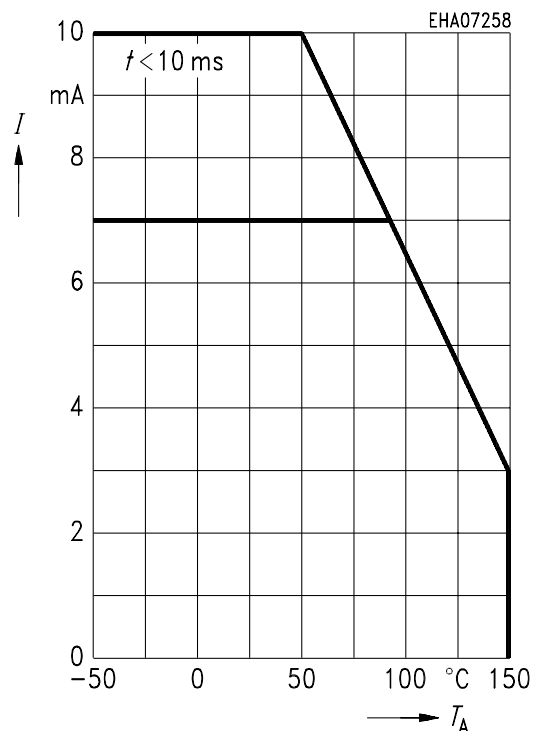



## Package Outlines

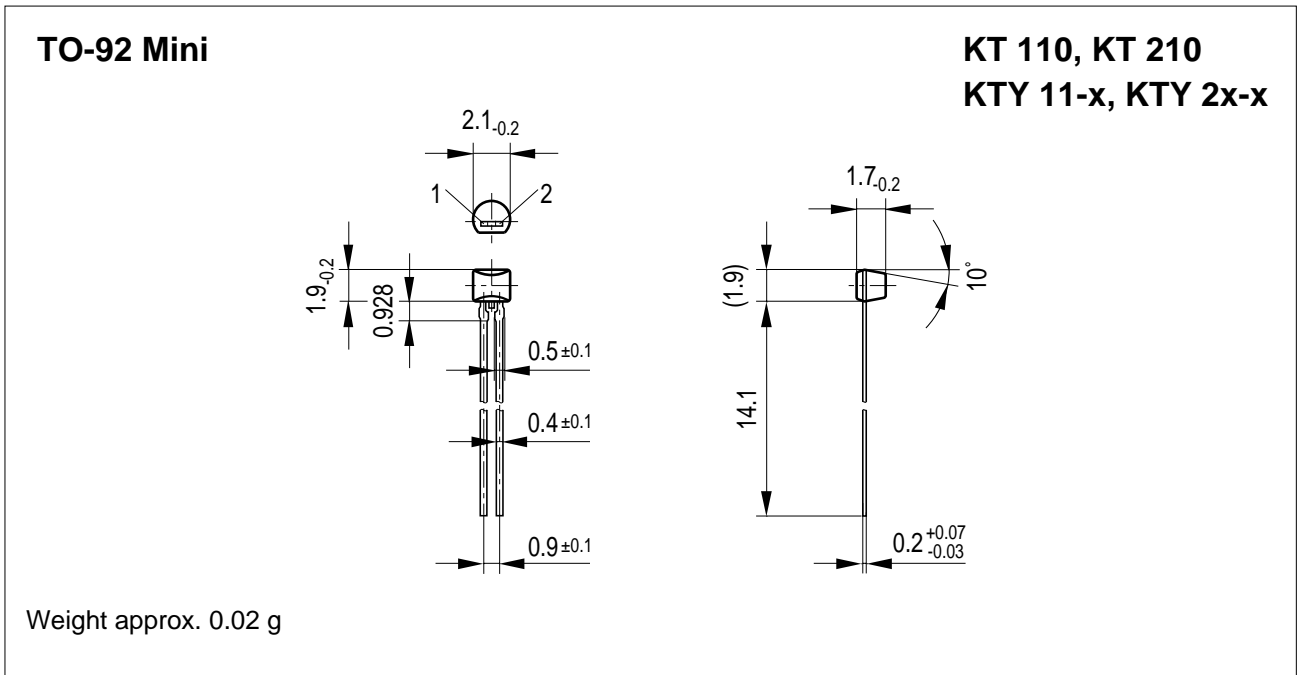
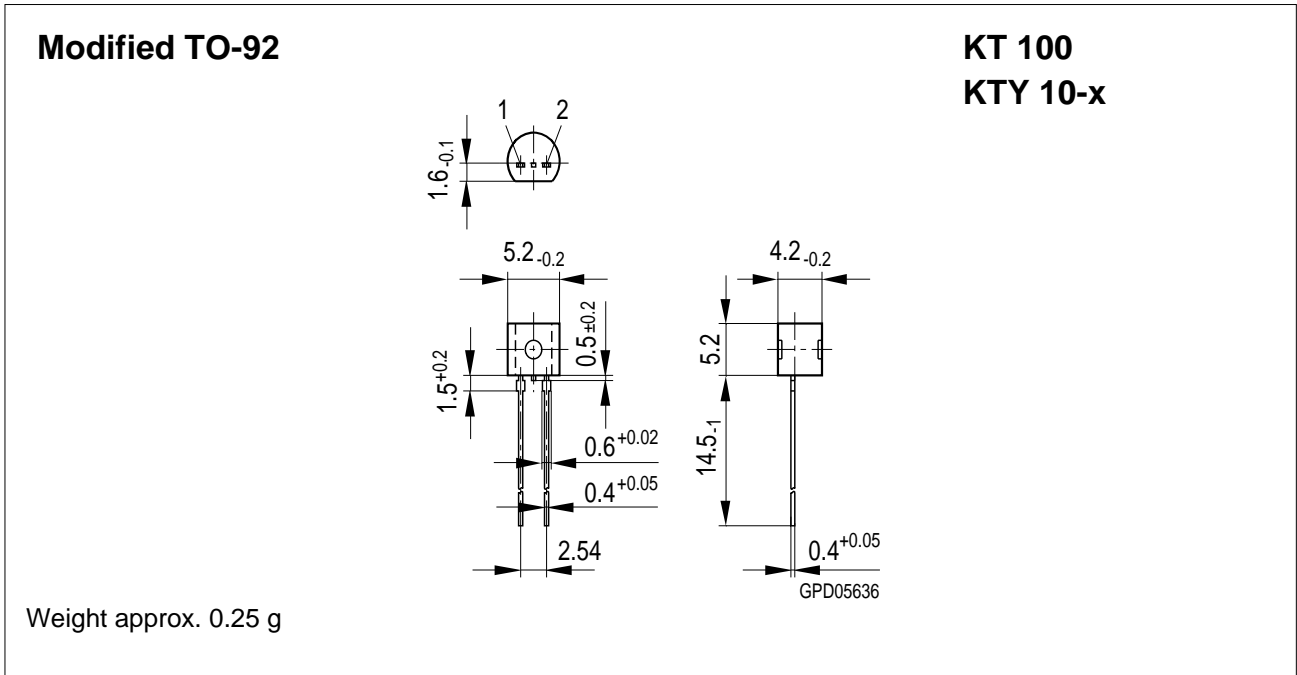

### Sorts of Packing

Package outlines for tubes, trays etc. are contained in our Data Book "Package Information".

Dimensions in mm

**SOT-23**  
(Small Outline Transistor)

**KT 130, KT 230**  
**KTY 13-x, KTY 23-x**

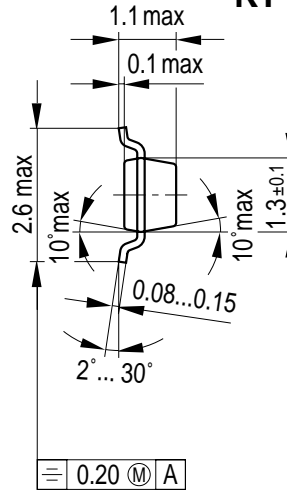
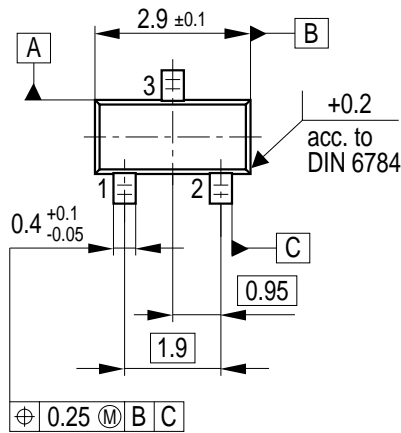

Weight approx. 0.01 g

Pins 1 - 2:  $R_{25}$

**Ni-plated Brass Tube Housing**  
**with Tefzel Isolated Leadwires**

**KTY 16-6**

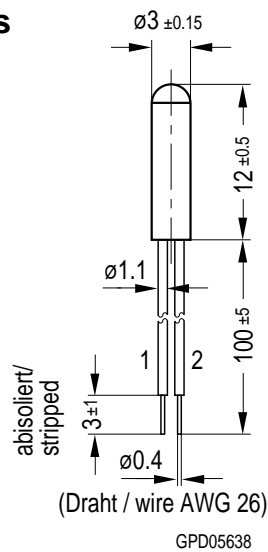

Weight approx. 0.07 g

**Sorts of Packing**

Package outlines for tubes, trays etc. are contained in our Data Book "Package Information".

**SMD = Surface Mounted Device**

Dimensions in mm

## Stainless Steel Housing, BSS303 (equiv. DIN 1.4305)

## KTY 19-6M/Z

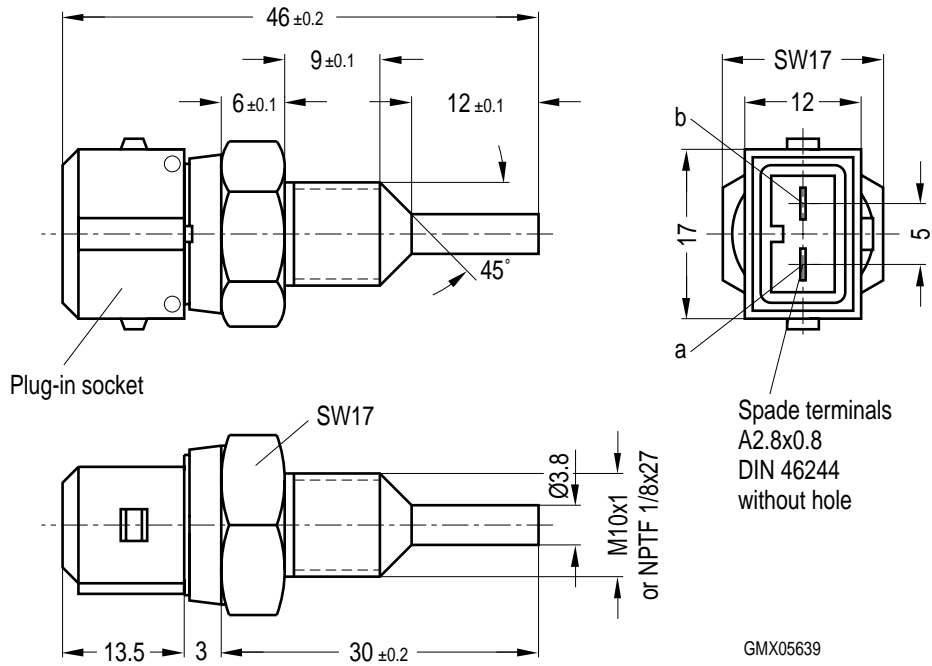

Weight approx. 20 g

### Sorts of Packing

Package outlines for tubes, trays etc. are contained in our Data Book "Package Information".

Dimensions in mm