

Photodetektor mit Spannungsausgang Light to Voltage Converter

SFH 5130

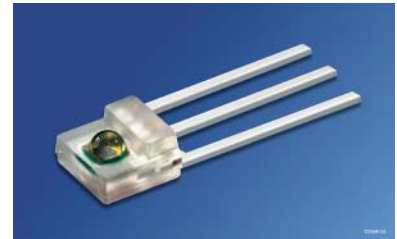

Wesentliche Merkmale

- Integrierter Fotodetektor mit linearem Spannungsausgang
- Transparentes Plastikgehäuse mit 3 Pins
- Hohe Empfindlichkeit von 350 nm bis 1100 nm
- Runde Fotodiode

Anwendungen

- Lichtschranken

Features

- Integrated photodiode with linear voltage output
- Transparent sidelooker package with 3 pins
- High sensitivity from 350 nm to 1100 nm
- Circular photodiode

Applications

- Photointerrupter

| Typ Type | Bestellnummer Ordering Code | Gehäuse Package |
|-------------|--------------------------------|--|
| SFH 5130 | on request | Sidelooker Gehäuse Sidelooker Package |

Grenzwerte
Maximum Ratings

| Bezeichnung Parameter | Symbol Symbol | Wert Value | Einheit Unit |
|---|------------------|-------------------|-----------------|
| Lagertemperatur Storage temperature range | T_{stg} | - 40 ... + 85 | °C |
| Versorgungsspannung Supply Voltage | V_{DD} | 6 | V |
| Ausgangsspannung Output voltage | V_{OUT} | < V_{DD} | V |
| Elektrostatische Entladung Electrostatic Discharge Human Body Model according to EOS/ESD-5.1-1993 | <i>ESD</i> | 2 | kV |

Empfohlener Arbeitsbereich
Recommended Operating Conditions

| Bezeichnung Parameter | Symbol Symbol | Wert Value | | | Einheit Unit |
|--|------------------|---------------|------|------|-----------------|
| | | min. | typ. | max. | |
| Funktionstemperatur Operating Temperature | T_{op} | - 40 | + 25 | + 75 | °C |
| Betriebsspannung Supply Voltage | V_{DD} | 4.5 | 5 | 5.5 | V |
| Kapazitive Ausgangslast Output load capacitance | C_{L} | | | 30 | nF |

Kennwerte ($T_{\text{A}} = 25 \text{ °C}$, $V_{\text{DD}} = 5 \text{ V}$, $R_{\text{L}} = 10 \text{ k}\Omega$)
Characteristics

| Bezeichnung Parameter | Symbol Symbol | Wert Value | | | Einheit Unit |
|---|------------------|---------------|------|------|-----------------|
| | | min. | typ. | max. | |
| Stromaufnahme, $E_{\text{e}} \neq 0$ Current consumption | I_{DD} | - | 1.5 | 4.5 | mA |
| Dunkelspannung Dark Voltage | V_{D} | - | 1.2 | 15 | mV |
| Spektraler Bereich der Fotoempfindlichkeit Spectral range of sensitivity | λ | 350 | - | 1100 | nm |

Kennwerte ($T_A = 25\text{ °C}$, $V_{DD} = 5\text{ V}$, $R_L = 10\text{ k}\Omega$)

Characteristics

| Bezeichnung Parameter | Symbol Symbol | Wert Value | | | Einheit Unit |
|--|--------------------------|---------------|---------|-------|--|
| | | min. | typ. | max. | |
| Wellenlänge der max. Fotoempfindlichkeit Wavelength of max. photosensitivity | $\lambda_{s\text{ max}}$ | – | 770 | – | nm |
| Durchmesser der aktiven Fläche Diameter of active area | D | – | 0.75 | – | mm |
| Empfindlichkeit ¹⁾ , $\lambda = 428\text{ nm}$ Irradiance responsivity | N_e | – | 1180 | – | mV/ $\mu\text{W}/\text{cm}^2$ |
| Ausgangsspannung ¹⁾ Output Voltage, $E_e = 1.69\text{ }\mu\text{W}/\text{cm}^2$, $\lambda = 428\text{ nm}$ | V_O | 1.0 | – | 3.2 | V |
| Sättigungsspannung, $V_{DD} = 4.5\text{ V}$, $E_e \geq 7\text{ }\mu\text{W}/\text{cm}^2$ Maximum output voltage swing | V_{sat} | 4 | 4.47 | – | V |
| Anstiegszeit ²⁾ , $E_e = 0$ to $E_e = 1.69\text{ }\mu\text{W}/\text{cm}^2$ Rise time | t_r | – | 50 | 250 | μs |
| Abfallzeit, $E_e = 1.69$ to $0\text{ }\mu\text{W}/\text{cm}^2$ Fall time | t_f | – | 70 | 250 | μs |
| Einschwingzeit, to 99% of nominal Settling time | t_s | – | 90 | – | μs |
| Temperaturkoeffizient der Dunkelspannung, $T = 5$ to 45 °C Temperature coefficient of dark voltage | α_{vd} | – 100 | ± 8 | + 100 | $\mu\text{V}/\text{K}$ |
| Temperaturkoeffizient der Ausgangsspannung Temperature coefficient of output voltage $E_e = 1.69\text{ }\mu\text{W}/\text{cm}^2$, $\lambda = 428\text{ nm}$, $T = 5$ to 45 °C | α_{vo} | – 3 | ± 1 | + 3 | mV/K |
| Power supply rejection ratio ³⁾ $f_{\text{ac}} = 100\text{ Hz}$ $f_{\text{ac}} = 1\text{ kHz}$ | PSRR PSRR | – | 45 | – | dB dB |
| Output noise voltage $f = 0$ to 1 kHz $f = 10\text{ Hz}$ $f = 100\text{ Hz}$ $f = 1\text{ kHz}$ | | | | | $\mu\text{V RMS}$ $\mu\text{V}/\text{Hz}^{(1/2)}$ $\mu\text{V}/\text{Hz}^{(1/2)}$ $\mu\text{V}/\text{Hz}^{(1/2)}$ |

1) The sensitivity is characterized using 428 nm LEDs as light source. A constant irradiance over the whole lens area is created.

- 2) The light source used is a 428 nm LED with following characteristics: $t_r > 1 \mu\text{s}$, $t_f < 1 \mu\text{s}$. The output waveform is monitored on an oscilloscope with $t_r > 100 \text{ ns}$, $Z_i = 1 \text{ M}\Omega$, $C_i < 20 \text{ pF}$. The rise time is defined as the time from the 10% to the 90% value, the fall time is defined as the time from the 90% to the 10% value.
- 3) PSRR is defined as $20 \log (V_{\text{DD}}(f) / V_{\text{O}}(f))$ with $V_{\text{DD}}(0 \text{ Hz}) = 4.5 \text{ V}$ and $V_{\text{O}}(0 \text{ Hz}) = 2 \text{ V}$

Lötbedingungen Soldering Conditions

| Type | Dip, wave and drag soldering | | |
|---------|-------------------------------|--------------------------------|---|
| | Temperature of soldering bath | Max permissible soldering time | Distance between solder joint and package |
| SFH5130 | 260 s | 10 s | 1.5 mm |

Spectral Sensitivity

$S_{rel} = f(\lambda)$

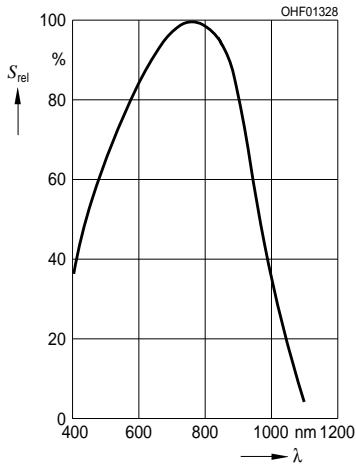

Current Consumption

$I_{DD} = f(V_{DD})$

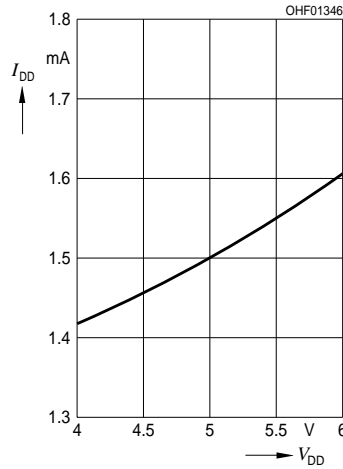

Dark Voltage

$V_D = f(V_{DD})$

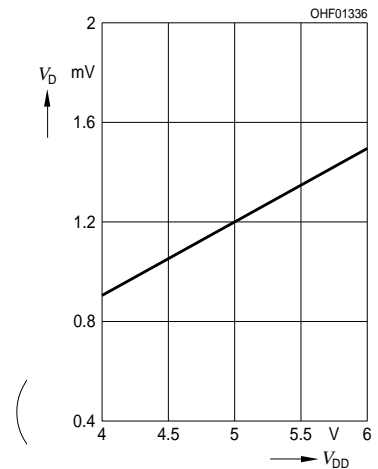

Output Voltage, $V_O = f(T_A)$, $E_e = 1.69 \mu W/cm^2, \lambda = 428 nm$

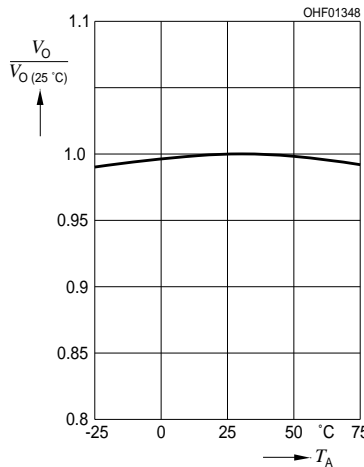

Current Consumption

$I_{DD} = f(T_A)$

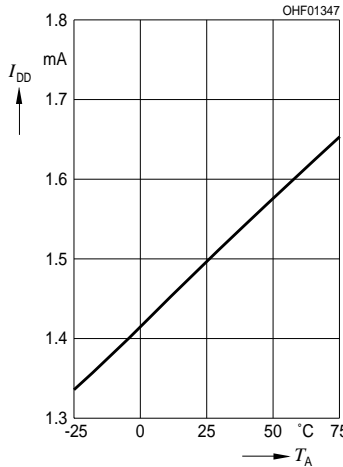

Dark Voltage

$V_D = f(T_A)$

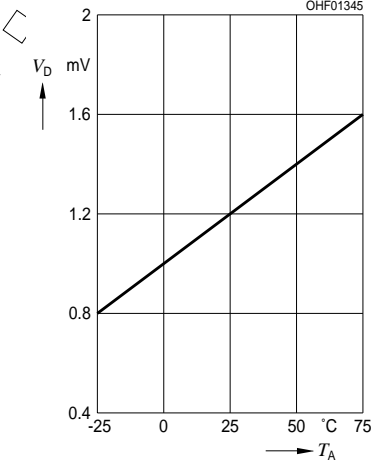

Linearity

$V_O = f(E_e)$

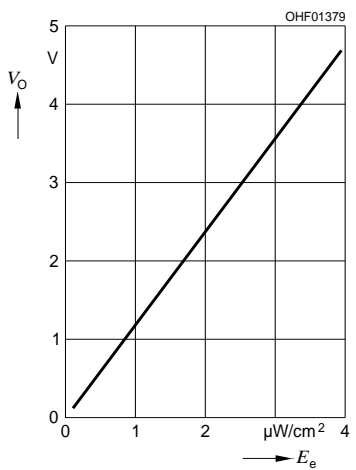

Directional Characteristics

$V_O = f(\phi)$

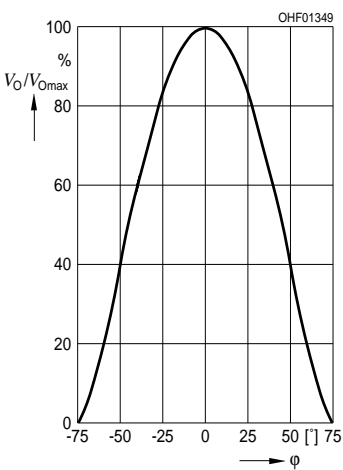

Maßzeichnung Package Outlines

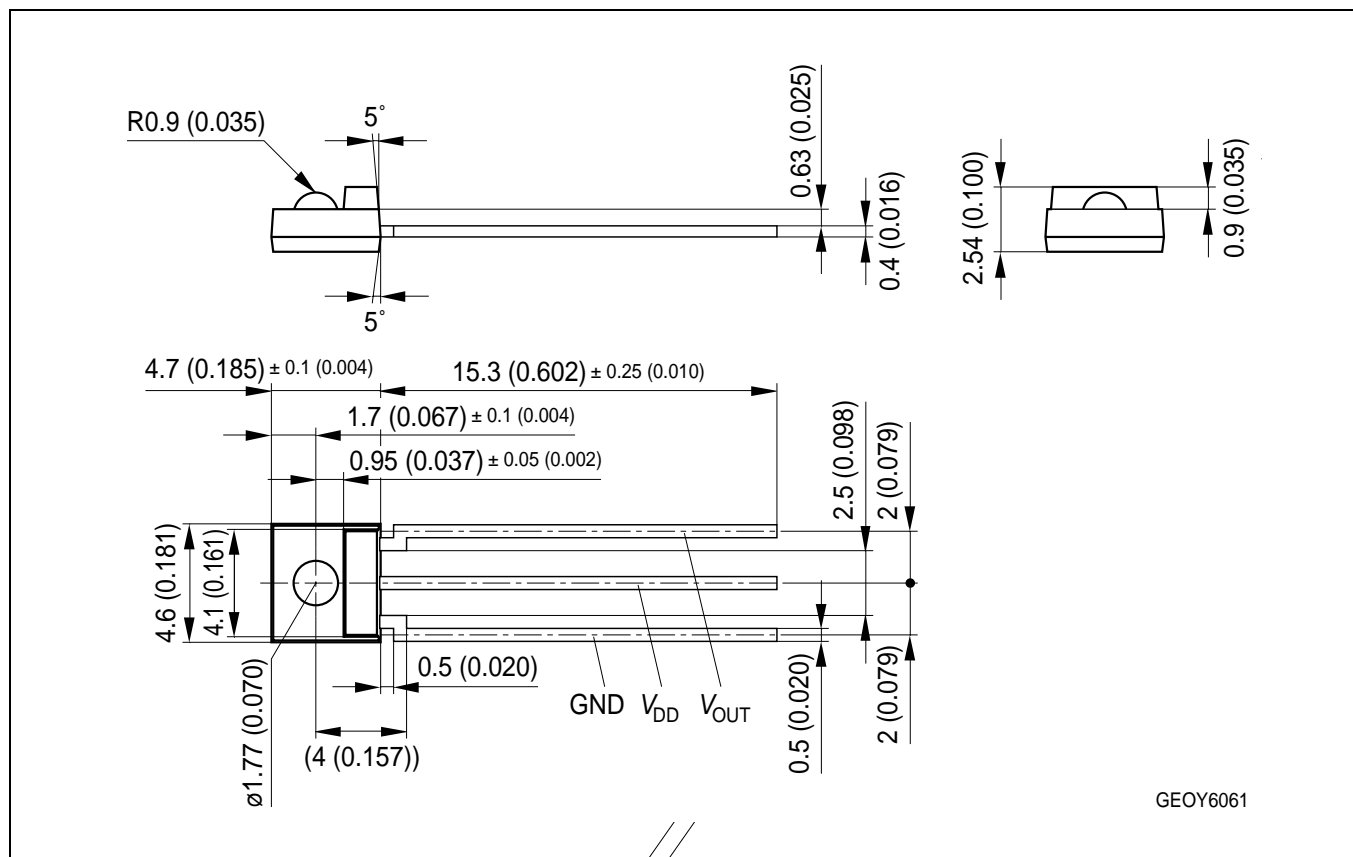

Maße werden wie folgt angegeben: mm (inch) / Dimensions are specified as follows: mm (inch).

Published by OSRAM Opto Semiconductors GmbH & Co. OHG
Wernerwerkstrasse 2, D-93049 Regensburg
© All Rights Reserved.

Attention please!

The information describes the type of component and shall not be considered as assured characteristics. Terms of delivery and rights to change design reserved. Due to technical requirements components may contain dangerous substances. For information on the types in question please contact our Sales Organization.

Packing

Please use the recycling operators known to you. We can also help you – get in touch with your nearest sales office. By agreement we will take packing material back, if it is sorted. You must bear the costs of transport. For packing material that is returned to us unsorted or which we are not obliged to accept, we shall have to invoice you for any costs incurred.

Components used in life-support devices or systems must be expressly authorized for such purpose! Critical components¹, may only be used in life-support devices or systems² with the express written approval of OSRAM OS.

¹ A critical component is a component used in a life-support device or system whose failure can reasonably be expected to cause the failure of that life-support device or system, or to affect its safety or effectiveness of that device or system.

² Life support devices or systems are intended (a) to be implanted in the human body, or (b) to support and/or maintain and sustain human life. If they fail, it is reasonable to assume that the health of the user may be endangered.