

TOSHIBA PHOTOINTERRUPTER INFRARED + PHOTODARLINGTONTRANSISTOR

# TLP871

VCR, COMPACT DISC PLAYER  
 COPYING MACHINE, FACSIMILE, PRINTER  
 VENDING MACHINE, TICKETING MACHINE  
 FOR VARIOUS POSITION DETECTION

The TLP871 is a photointerrupter combining GaAs infrared LED with high sensitivity Si photodarlingtontransistor.

The TLP871 has a high current transfer ratio, can be driven by low input current and is best suited to a low power circuit.

- Small package
- Printed wiring board direct mounting type.
- Gap : 3mm
- Resolution : Slit width 0.5mm
- High current transfer ratio :  $I_C / I_F = 50\%$  (min) at  $I_F = 1\text{mA}$
- The detector side is of visible light cut type.
- Material of the package : Polycarbonate

Unit in mm

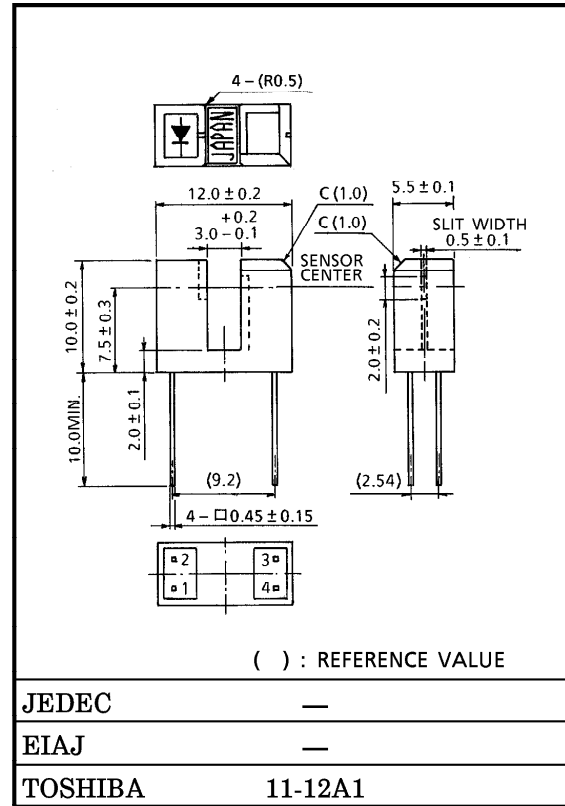

Weight : 0.59g (typ.)

MAXIMUM RATINGS (Ta = 25°C)

CHARACTERISTIC		SYMBOL	RATING	UNIT
LED	Forward Current	$I_F$	50	mA
	Forward Current Derating (Ta > 25°C)	$\Delta I_F / ^\circ\text{C}$	-0.33	mA / °C
	Reverse Voltage	$V_R$	5	V
DETECTOR	Collector-Emitter Voltage	$V_{CEO}$	30	V
	Emitter-Collector Voltage	$V_{ECO}$	5	V
	Collector Power Dissipation	$P_C$	75	mW
	Collector Power Dissipation Derating (Ta > 25°C)	$\Delta P_C / ^\circ\text{C}$	-1	mW / °C
	Collector Current	$I_C$	40	mA
Operating Temperature Range		$T_{opr}$	-25~85	°C
Storage Temperature Range		$T_{stg}$	-40~100	°C
Soldering Temperature (5s)		$T_{sol}$	260	°C

PIN CONNECTION

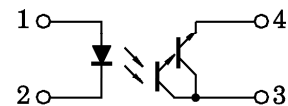

1. ANODE
2. CATHODE
3. COLLECTOR
4. EMITTER

961001EBC2

● TOSHIBA is continually working to improve the quality and the reliability of its products. Nevertheless, semiconductor devices in general can malfunction or fail due to their inherent electrical sensitivity and vulnerability to physical stress. It is the responsibility of the buyer, when utilizing TOSHIBA products, to observe standards of safety, and to avoid situations in which a malfunction or failure of a TOSHIBA product could cause loss of human life, bodily injury or damage to property. In developing your designs, please ensure that TOSHIBA products are used within specified operating ranges as set forth in the most recent products specifications. Also, please keep in mind the precautions and conditions set forth in the TOSHIBA Semiconductor Reliability Handbook.

**RECOMMENDED OPERATING CONDITION**

CHARACTERISTIC	SYMBOL	MIN.	TYP.	MAX.	UNIT
Supply Voltage	V <sub>CC</sub>	—	5	16	V
Forward Current	I <sub>F</sub>	—	—	20	mA
Operating Temperature	T <sub>opr</sub>	-10	—	70	°C

**OPTO-ELECTRICAL CHARACTERISTICS (Ta = 25°C)**

CHARACTERISTIC		SYMBOL	TEST CONDITION	MIN.	TYP.	MAX.	UNIT
LED	Forward Voltage	V <sub>F</sub>	I <sub>F</sub> = 10mA	1.00	1.15	1.30	V
	Reverse Current	I <sub>R</sub>	V <sub>R</sub> = 5V	—	—	10	μA
	Peak Emission Wavelength	λ <sub>P</sub>	I <sub>F</sub> = 10mA	—	940	—	nm
DETECTOR	Dark Current	I <sub>D</sub> (I <sub>CEO</sub> )	V <sub>CE</sub> = 16V, I <sub>F</sub> = 0	—	—	0.25	μA
	Peak Sensitivity Wavelength	λ <sub>P</sub>	—	—	870	—	nm
COUPLED	Current Transfer Ratio	I <sub>C</sub> / I <sub>F</sub>	V <sub>CE</sub> = 2V, I <sub>F</sub> = 1mA	50	—	2000	%
	Collector-Emitter Saturation Voltage	V <sub>CE</sub> (sat)	I <sub>F</sub> = 2mA, I <sub>C</sub> = 0.5mA	—	0.75	1	V
	Rise Time	t <sub>r</sub>	V <sub>CC</sub> = 5V, I <sub>C</sub> = 10mA R <sub>L</sub> = 100Ω	—	80	400	μs
	Fall Time	t <sub>f</sub>		—	70	340	

**PRODUCT INDICATION**

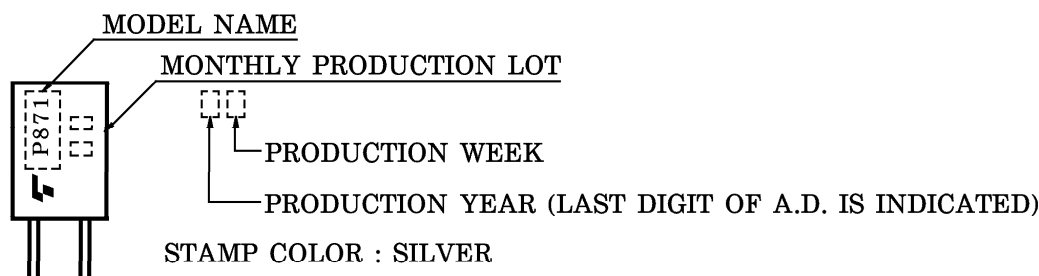

961001EBC2'

- Gallium arsenide (GaAs) is a substance used in the products described in this document. GaAs dust and fumes are toxic. Do not break, cut or pulverize the product, or use chemicals to dissolve them. When disposing of the products, follow the appropriate regulations. Do not dispose of the products with other industrial waste or with domestic garbage.
- The products described in this document are subject to foreign exchange and foreign trade control laws.
- The information contained herein is presented only as a guide for the applications of our products. No responsibility is assumed by TOSHIBA CORPORATION for any infringements of intellectual property or other rights of the third parties which may result from its use. No license is granted by implication or otherwise under any intellectual property or other rights of TOSHIBA CORPORATION or others.
- The information contained herein is subject to change without notice.

PRECAUTION

Please be careful of the followings.

1. If chemical are used for cleaning, the soldered surface only shall be cleaned with chemicals avoiding the whole cleaning of the package.
2. The container is made of polycarbonate. Polycarbonate is usually stable with acid, alcohol, and aliphatic hydrocarbons however, with peroxochemicals (such as benzene, toluene, and acetone), alkali, aromatic hydrocarbons, or chloric hydrocarbons, polycarbonate becomes cracked, swollen, or melted. Please take care when choosing a packaging material by referencing the table below.

<Chemicals to avoid with polycarbonate>

	PHENOMENON	CHEMICALS
A	Little deterioration but staining	<ul style="list-style-type: none"> <li>• nitric acid (low concentration), hydrogen peroxide, chlorine</li> </ul>
B	Cracked, crazed, or swollen	<ul style="list-style-type: none"> <li>• acetic acid (70% or more)</li> <li>• gasoline</li> <li>• methyl ethyl ketone, ethyl acetate, butyl acetate</li> <li>• ethyl methacrylate, ethyl ether, MEK</li> <li>• acetone, m-amino alcohol, carbon tetrachloride</li> <li>• carbon disulfide, trichloroethylene, cresol</li> <li>• thinners, oil of turpentine</li> <li>• triethanolamine, TCP, TBP</li> </ul>
C	Melted { } : Used as solvent.	<ul style="list-style-type: none"> <li>• concentrated sulfuric acid</li> <li>• benzene</li> <li>• styrene, acrylonitrile, vinyl acetate</li> <li>• ethylenediamine, diethylenediamine</li> <li>• {chloroform, methyl chloride, tetrachloromethane, dioxane, } • {1, 2-dichloroethane }</li> </ul>
D	Decomposed	<ul style="list-style-type: none"> <li>• ammonia water</li> <li>• other alkali</li> </ul>

3. TLP871 shall be mounted on an unwarped surface.

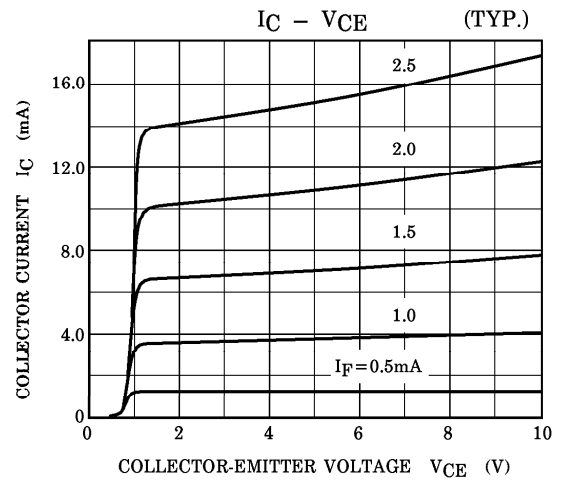
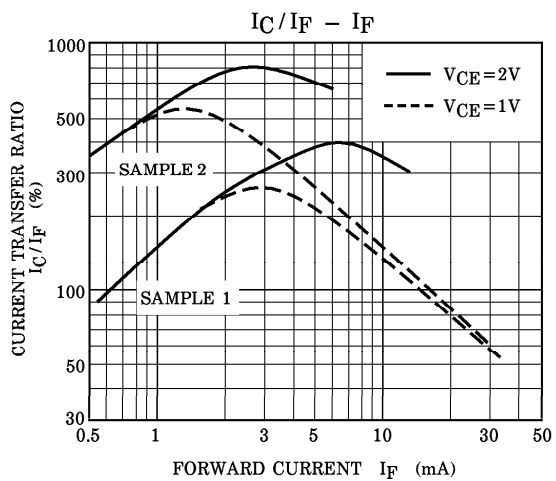
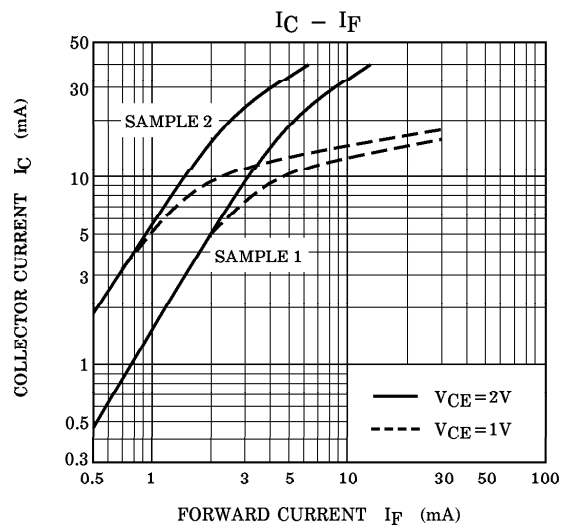
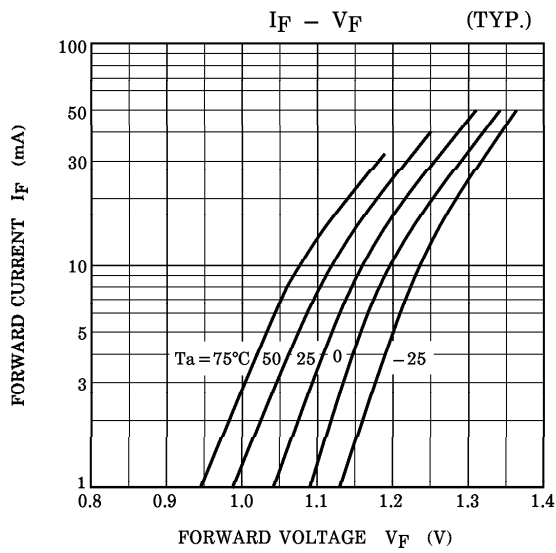
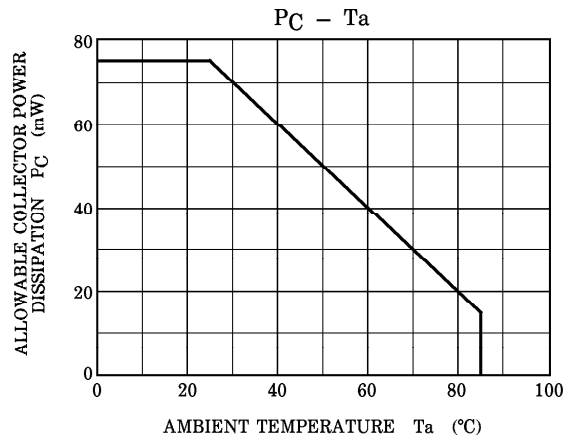
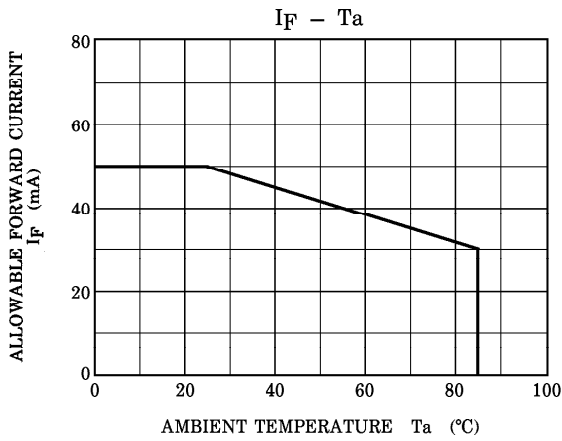

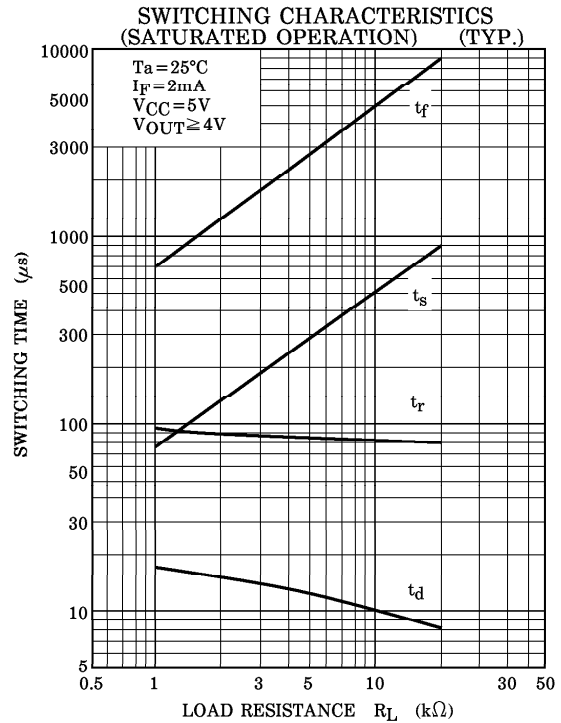
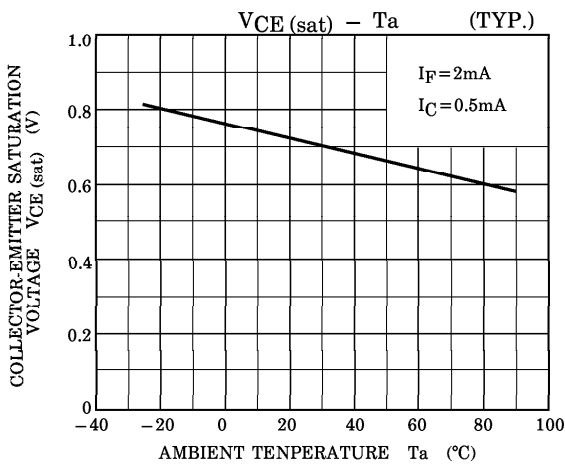
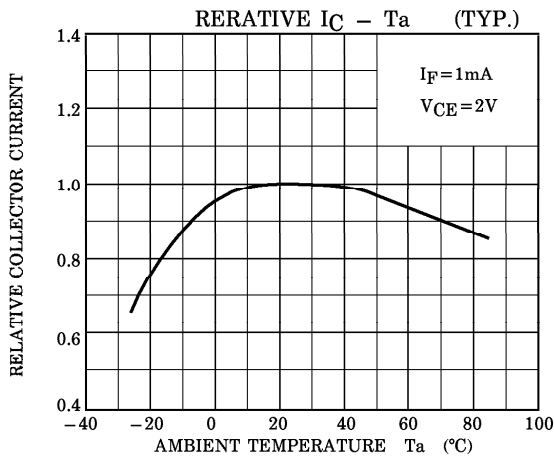
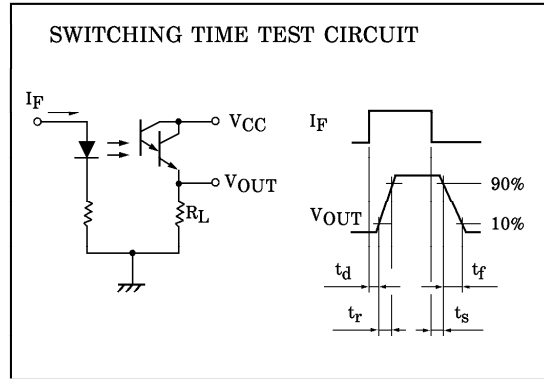
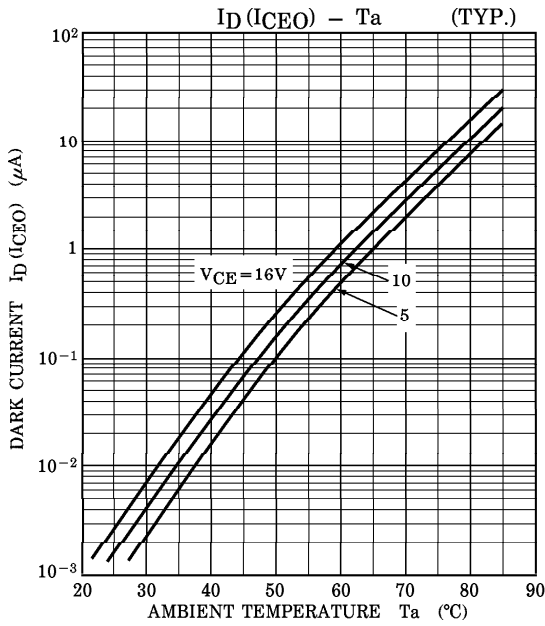

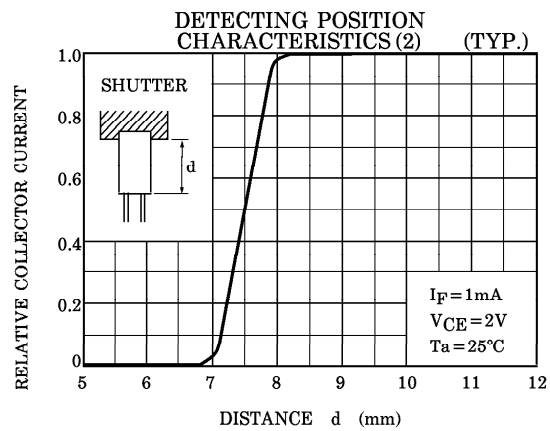
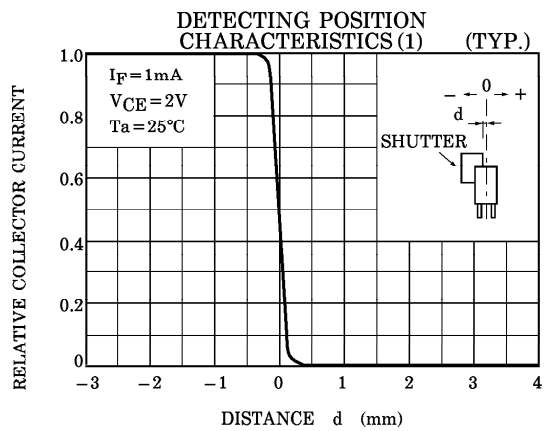

**POSITIONING OF SHUTTER AND DEVICE**

To operate correctly, make sure that the shutter and the device are positioned as shown in the figure below.

The slit pitch of the shutter must be set wider than the slit width of the device. Determine the width taking the switching time into consideration.

