

Si photodiode

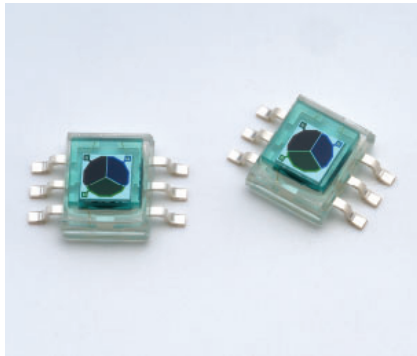

S9032-02

RGB color sensor

The S9032-02 is a color sensor molded into a plastic package having a 3-channel (RGB) photodiode sensitive to the blue ($\lambda_p=460$ nm), green ($\lambda_p=540$ nm) and red ($\lambda_p=620$ nm) regions of the spectrum. The S9032-02 has a 3-segment (RGB) circular active area of $\phi 2$ mm.

Features

- 3-channel (RGB) Si photodiode
- Surface-mount small plastic package
- Spectral response range close to the human eye sensitivity
- No sensitivity in the near IR region
- Active area: 3-segment (RGB) circular active area of $\phi 2$ mm

Applications

- Color adjustment for LED back light system for LCD
- Color adjustment for LCD projector
- Color tester
- Color detection

Absolute maximum ratings

Parameter	Symbol	Value	Unit
Reverse voltage	V_R Max.	10	V
Operating temperature	T_{opr}	-25 to +85	°C
Storage temperature	T_{stg}	-40 to +85	°C

Electrical and optical characteristics ($T_a = 25$ °C, per element)

Parameter	Symbol	Condition	Min.	Typ.	Max.	Unit	
Spectral response range	λ	Blue	-	400 to 540	-	nm	
		Green	-	480 to 600	-		
		Red	-	590 to 720	-		
Peak sensitivity wavelength	λ_p	Blue	-	460	-	nm	
		Green	-	540	-		
		Red	-	620	-		
Photo sensitivity	S	$\lambda = \lambda_p$	Blue	0.13	0.18	-	A/W
			Green	0.18	0.23	-	
			Red	0.11	0.16	-	
Dark current	I_D	$V_R = 1$ V All elements	-	5	100	pA	
Temperature coefficient of I_D	T_{CID}		-	1.12	-	times/°C	
Rise time	t_r	$V_R = 0$ V, $R_L = 1$ k Ω 10 to 90 %	-	0.2	1.0	μ s	
Terminal capacitance	C_t	$V_R = 0$ V $f = 10$ kHz	-	40	80	pF	

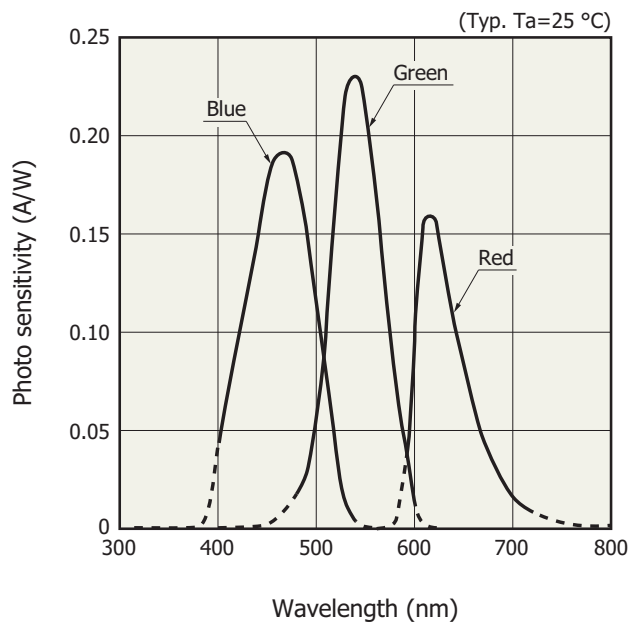
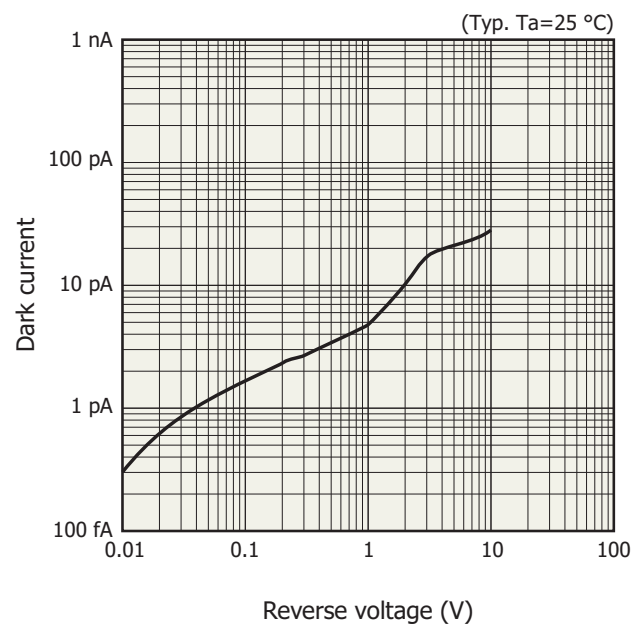
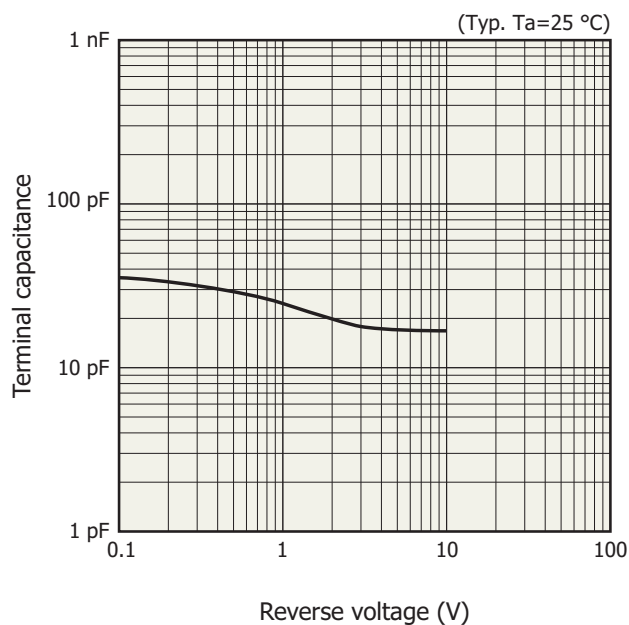
Spectral response**Dark current vs. reverse voltage****Terminal capacitance vs. reverse voltage**

Dimensional outline (unit: mm)

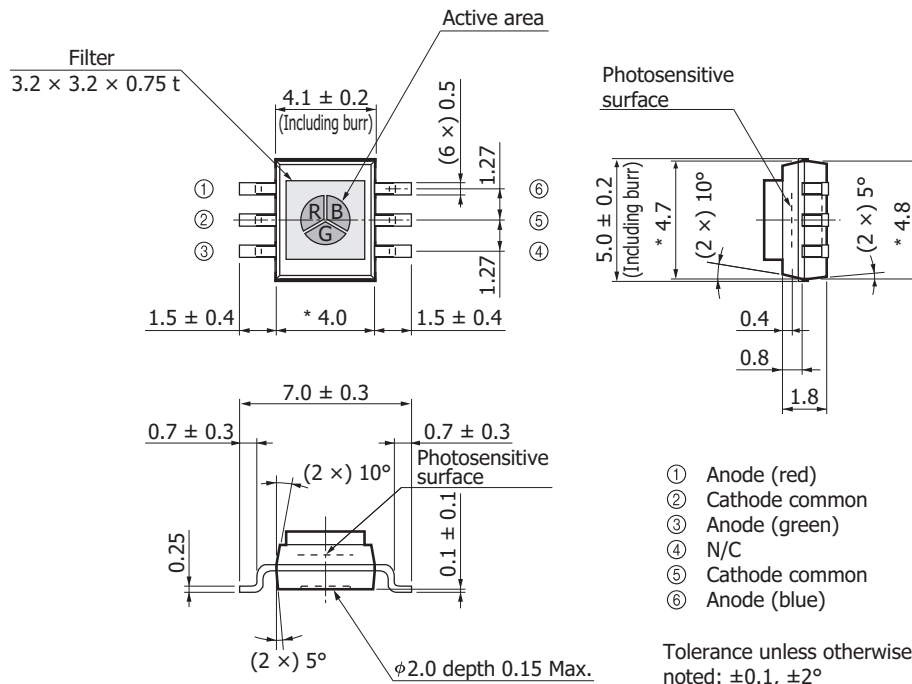

KSPDA0162EA

Note: If excessive vibration is continuously applied to the glass filter, there is a risk that the filter may come off, so secure the glass filter with a holder.





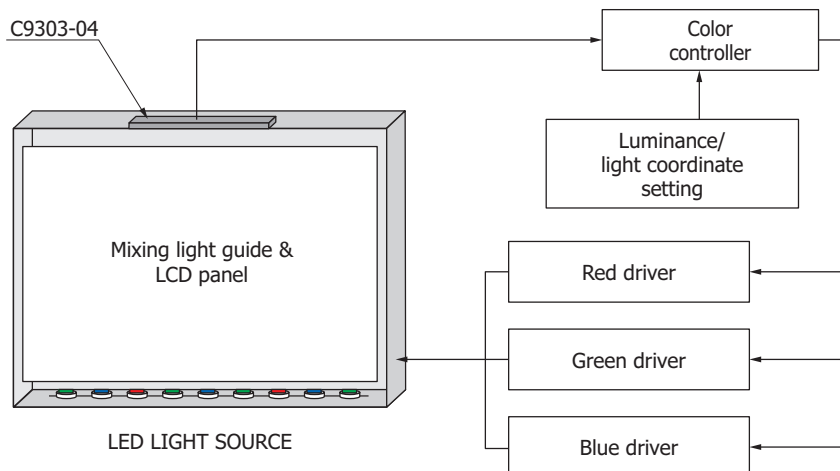







Application example

Optical feedback of backlight for TFT-LCD using a color sensor module C9303-04 (integrated with the S9032-02)



LED: Made by Lumileds (LUXEON), <http://www.lumileds.com/>

Line-up of RGB color sensors

Type No.	Type	Active area size (mm)	Package (mm)	Peak sensitivity wavelength (nm)	Photo sensitivity				Photo					
S9032-02	Photodiode	 $\phi 2.0$	4 × 4.8 × 1.8 ^t 6-pin (filter 0.75 ^t)	B	460	B	0.18 (A/W) [$\lambda=460$ nm]							
				G	540	G	0.23 (A/W) [$\lambda=540$ nm]							
				R	620	R	0.16 (A/W) [$\lambda=620$ nm]							
S9702	Photodiode	 1.0 × 1.0	3 × 4 × 1.3 ^t 4-pin (filter 0.75 ^t)	B	460	B	0.18 (A/W) [$\lambda=460$ nm]							
				G	540	G	0.23 (A/W) [$\lambda=540$ nm]							
				R	620	R	0.16 (A/W) [$\lambda=620$ nm]							
S10917-35GT	Photodiode	 1.0 × 1.0	3 × 1.6 × 1.0 ^t COB (on-chip filter)	B	460	B	0.2 (A/W) [$\lambda=460$ nm]							
				G	540	G	0.23 (A/W) [$\lambda=540$ nm]							
				R	620	R	0.17 (A/W) [$\lambda=620$ nm]							
S10942-01CT	Photodiode	 1.0 × 1.0	3 × 1.6 × 1.0 ^t COB (on-chip filter)	*		B	0.21 (A/W) [$\lambda=460$ nm]							
						G	0.25 (A/W) [$\lambda=540$ nm]							
						R	0.45 (A/W) [$\lambda=640$ nm]							
S9706	Digital Photo IC	 1.2 × 1.2	4 × 4.8 × 1.8 ^t 6-pin (filter 0.75 ^t)	B	465	Low	B	0.21 (LSB/lx)	High	B	1.9 (LSB/lx)			
				G	540		G	0.45 (LSB/lx)		G	4.1 (LSB/lx)			
				R	615		R	0.64 (LSB/lx)		R	5.8 (LSB/lx)			
S11059-01WT	I ² C interface- compatible color sensor	 1.22 × 0.56	1.68 × 1.18 × 0.58 ^t WL-CSP (on-chip filter)	B	460	Low	B	3.35 (counts/lx)	High	B	31.7 (counts/lx)			
				G	530		G	7.61 (counts/lx)		G	76.2 (counts/lx)			
				R	615		R	9.48 (counts/lx)		R	94.5 (counts/lx)			
				IR	855		IR	1.66 (counts/lx)		IR	15.3 (counts/lx)			

* Refer to "Spectral response" of "Si photodiode S10942-01CT" datasheet.

Information described in this material is current as of January, 2011. Product specifications are subject to change without prior notice due to improvements or other reasons. Before assembly into final products, please contact us for the delivery specification sheet to check the latest information.

Type numbers of products listed in the delivery specification sheets or supplied as samples may have a suffix "(X)" which means preliminary specifications or a suffix "(Z)" which means developmental specifications.

The product warranty is valid for one year after delivery and is limited to product repair or replacement for defects discovered and reported to us within that one year period. However, even if within the warranty period we accept absolutely no liability for any loss caused by natural disasters or improper product use.

Copying or reprinting the contents described in this material in whole or in part is prohibited without our prior permission.

HAMAMATSU

www.hamamatsu.com

HAMAMATSU PHOTONICS K.K., Solid State Division

1126-1 Ichino-cho, Higashi-ku, Hamamatsu City, 435-8558 Japan, Telephone: (81) 53-434-3311, Fax: (81) 53-434-5184

U.S.A.: Hamamatsu Corporation: 360 Foothill Road, P.O.Box 6910, Bridgewater, N.J. 08807-0910, U.S.A., Telephone: (1) 908-231-0960, Fax: (1) 908-231-1218

Germany: Hamamatsu Photonics Deutschland GmbH: Arzbergerstr. 10, D-82211 Herrsching am Ammersee, Germany, Telephone: (49) 8152-375-0, Fax: (49) 8152-265-8

France: Hamamatsu Photonics France S.A.R.L.: 19, Rue du Saule Trapu, Parc du Moulin de Massy, 91882 Massy Cedex, France, Telephone: 33-(1) 69 53 71 00, Fax: 33-(1) 69 53 71 10

United Kingdom: Hamamatsu Photonics UK Limited: 2 Howard Court, 10 Tewin Road, Welwyn Garden City, Hertfordshire AL7 1BW, United Kingdom, Telephone: (44) 1707-294888, Fax: (44) 1707-325777

North Europe: Hamamatsu Photonics Norden AB: Smidesvägen 12, SE-171 41 Solna, Sweden, Telephone: (46) 8-509-031-00, Fax: (46) 8-509-031-01

Italy: Hamamatsu Photonics Italia S.R.L.: Strada della Moia, 1 int. 6, 20020 Arese, (Milano), Italy, Telephone: (39) 02-935-81-733, Fax: (39) 02-935-81-741