

Windows 2000 Keyboard Encoder

Features

- Design for Windows 95/98/2000/NT
- Supports Windows™ keys
- Supports PC/AT and PS/2 code set 1, 2, 3
- Supports Japanese , Korean , Brazilian and European
- RC oscillator
- Phantom key detection
- Low power consumption
- 101/102/104/105/107/109 keys or other special application keyboard encoder
- 8 external hot keys
- Supports Mini-keyboard and Internet/Multimedia keyboard
- WINDOWS is a registered trademark of Microsoft corporation
- 40-pin DIP package

General Description

The HT82K628A is a keyboard encoder designed for IBM PC/AT, IBM PS/2 and all compatible machines.

The HT82K628A accepts keyboard inputs and provides a 16-character first-in-first-out buffer in which data is stored.

An inexpensive RC oscillator can be used for the system clock. Simple implementation of this device is an advantage for high performance and low cost keyboard applications.

Pin Assignment

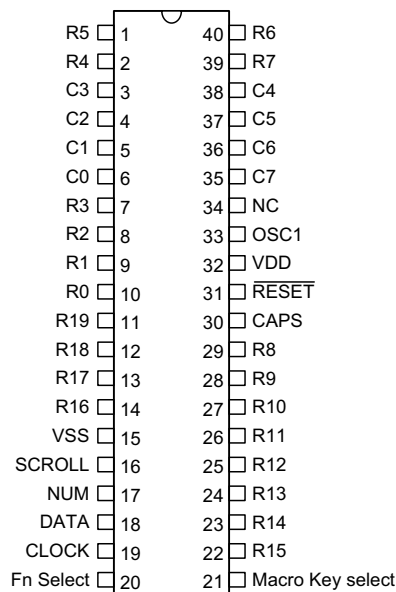

HT82K628A
- 40 DIP-A

Pin Description

Pin No.	Pin Name	I/O	Description
10~7, 2~1, 40~39, 29~22, 14~11	R0~R19	O	Keyboard matrix scanning output pins
6~3, 38~35	C0~C7	I	Keyboard matrix scanning input pins
15	VSS	—	Negative power supply, ground
16	SCROLL	O	Scroll Lock indicator
17	NUM	O	Num Lock indicator
18	DATA	I/O	Bidirectional data transmission line
19	CLOCK	I/O	Synchronous clock signal. Used to clock the transmission data.
20	Fn Select	I	Mini-keyboard select, enables the function if connected to VSS.
21	Macro Key Select	I	Macro Key select, disables the function if connected to VSS.
30	CAPS	O	Caps Lock indicator
31	RESET	I	Chip reset input. Active low. Built-in power-on reset circuit to reset the entire chip. Chip can also be externally reset via RESET pin.
32	VDD	—	5.0V positive power supply
33	OSC1	I	System clock input; 58.3kΩ resistor connected for RC OSC
34	NC	—	No connection

Absolute Maximum Ratings

Supply Voltage $V_{SS}-0.3V$ to $V_{SS}+5.5V$ Storage Temperature $-50^{\circ}C$ to $125^{\circ}C$

Input Voltage $V_{SS}-0.3V$ to $V_{DD}+0.3V$ Operating Temperature $-25^{\circ}C$ to $70^{\circ}C$

Note: These are stress ratings only. Stresses exceeding the range specified under "Absolute Maximum Ratings" may cause substantial damage to the device. Functional operation of this device at other conditions beyond those listed in the specification is not implied and prolonged exposure to extreme conditions may affect device reliability.

Electrical Characteristics
 $T_a=25^{\circ}C$

Symbol	Parameter	Test Conditions		Min.	Typ.	Max.	Unit
		V_{DD}	Conditions				
V_{DD}	Operating Voltage	—	—	3	5	5.25	V
I_{DD}	Operating Current (RC OSC)	5V	No load, $f_{SYS}=4MHz$	—	2.5	5	mA
V_{IL}	Input Low Voltage	5V	—	0	—	1.5	V
V_{IH}	Input High Voltage	5V	—	3.5	—	5	V
I_{OL}	Sink Current	5V	$V_{OL}=0.5V$	7	12	—	mA
I_{OH}	Source Current	5V	$V_{OH}=4.5V$	-2.5	-4.5	—	mA
I_{LED}	LED Sink Current (Scroll, Num, Caps)	5V	$V_{OL}=3.2V$	10	14	18	mA
R_{ph}	Internal Pull-high Resistance (C0~C7, R0~R19)	5V	—	5	12	20	kΩ
R_{ph1}	Internal Pull-high Resistance (DATA, CLOCK)	5V	—	2	4.7	8	kΩ
R_{ph2}	Internal Pull-high Resistance (\overline{RESET})	5V	—	25	50	75	kΩ
f_{SYS}	System Clock (RC OSC)	5V	—	—	4	—	MHz

Functional Description

Command from the host

The following table shows the commands that the host may send and their hexadecimal values.

Command	Hex Value
Set/Reset Status Indicators	ED
Echo	EE
Invalid Command	EF
Select Alternate Scan Codes	F0
Invalid Command	F1
Read ID	F2
Set Typematic Rate/Delay	F3
Enable	F4
Default Disable	F5
Set Default	F6
Set All Keys - Typematic	F7
Set All Keys - Make/Break	F8
Set All Keys - Make	F9
Set All Keys - Typematic/Make/Break	FA
Set Key Type - Typematic	FB
Set Key Type - Make/Break	FC
Set Key Type - Make	FD
Resend	FE
Reset	FF

The commands may be sent to the HT82K628A at any time and the HT82K628A will respond within 25ms except when performing the internal diagnostics or executing a Reset command.

EDH – Set/Reset status indicators

Three status indicators on the keyboard-Num Lock, Caps Lock, and Scroll Lock-are accessible by the host. The HT82K628A activates or deactivates these indicators when it receives a valid command-code sequence from the system. The command sequence begins with the command byte (hex ED). The HT82K628A responds to the command byte with ACK, discontinues scanning, assignments for this option byte are as follow:

Bit	Indicator
0	Scroll Lock Indicator
1	Num Lock Indicator
2	Caps Lock Indicator
3~7	Reserved (Must be 0)

If a bit for an indicator is set to 1, the indicator is turned on. If a bit is set to 0, the indicator is turned off.

The HT82K628A responds to the option byte with ACK, sets the indicators and if the HT82K628A was previously enabled, continues scanning. The status of the indicators will reflect the bits in the option byte and can be activated or deactivated in any combination. If another command is received in place of the option byte, execution of the Set/Reset Mode Indicators command is stopped, with no change to the indicator status, and the new command is processed.

Immediately after power-on, the lights default to the off state. If the Set Default and Default Disable commands are received, the lamps remain in the state they were in before the command was received.

EEH – Echo

Echo is a diagnostic aid. When the HT82K628A receives this command, it issues a hex EE response and if the HT82K628A was previously enabled, continues scanning.

EFH and F1H – Invalid command

EFh and F1h are invalid commands and are not supported. If HT82K628A receives one of these and sends it, the HT82K628A will not acknowledge the command, but returns a Resend command and continues in its previous scanning state.

F0H – Select alternate scan codes

This command instructs the HT82K628A to select one of the three sets of scan codes. The HT82K628A acknowledges receipt of this command with ACK, clears both the output buffer and the typematic key. The host then sends the option byte and the keyboard responds with another ACK. An option byte value of hex 01 selects scan code set 1, hex 02 selects set 2 and hex 03 selects code set3.

An option byte value of hex 00 causes the HT82K628A to acknowledge with ACK and sends a byte telling the host which scan code set is currently in use.

After establishing the new scan code set, the HT82K628A returns to the scanning state it was in before receiving the Select Alternate Scan Codes command.

F2H – Read ID

This command requests identification information from the HT82K628A. The HT82K628A responds with ACK, discontinues scanning and sends the two keyboard ID bytes hex 83h and Abh. After the output of the second ID byte, the HT82K628A resumes scanning.

F3H – Set typematic Rate/Delay

The host issues the Set Typematic Rate/Delay command to change the typematic rate and delay. The HT82K628A responds to the command with ACK, stops scanning and waits for the system to issue the rate/delay value byte. The HT82K628A responds to the value byte with another ACK, sets the rate and delay to the value indicated, and continues scanning (if it was previously enabled). Bit6 and 5 indicate the delay, and bits 4, 3, 2, 1 and 0 indicate the rate. Bit7 is always 0. The delay is equal to 1 plus the binary value bit 6 and 5, multiplied by 250ms±20%.

The period (interval from one typematic output to the next) is determined by the following equation:

$$\text{Period} = (8+A) \cdot (2^B) \cdot 0.00417 \text{ seconds.}$$

Where:

A = binary value of bits 2, 1, and 0.

B = binary value of bits 4, and 3.

The typematic rate is 1 for each period and are listed as follows:

Bit	Typematic Rate ± 20%	Bit	Typematic Rate ± 20%
00000	30.0	10000	7.5
00001	26.7	10001	6.7
00010	24.0	10010	6.0
00011	21.8	10011	5.5
00100	20.0	10100	5.0
00101	18.5	10101	4.6
00110	17.1	10110	4.3
00111	16.0	10111	4.0
01000	15.0	11000	3.7
01001	13.3	11001	3.3
01010	12.0	11010	3.0
01011	10.9	11011	2.7
01100	10.0	11100	2.5
01101	9.2	11101	2.3
01110	8.0	11110	2.1
01111	8.0	11111	2.0

The default values for the HT82K628A are as follows:

Typematic rate= 10.9 characters per second ± 20%

Delay = 500ms±20%

The execution of this command stops without change to the existing rate if another command is received instead of the rate/delay value byte.

F4H – Enable

Upon receipt of this command, the HT82K628A will respond with ACK, clears its output buffer, clears the last typematic key, and starts scanning.

F5H – Default disable

The Default Disable command resets all conditions to the power on default states. The HT82K628A will respond with ACK, clears its output buffer, sets the default key types (scan code set 3 operation only) and typematic rate/delay, and clears the last typematic key. The HT82K628A then stops scanning and awaits further command.

F6H – Set default

The Set Default command resets all conditions to the power on default states. The HT82K628A will respond with ACK, clears its output buffer, sets the default key types (scan code set 3 operation only) and typematic rate/delay, and clears the last typematic key then continues scanning.

F7H, F8H, F9H, FAH – Set all keys

These commands instruct the HT82K628A to set all keys to the type listed below:

Hex Value	Command
F7	Set All Keys-Typematic
F8	Set All Keys-Make/Break
F9	Set All Keys-Make
FA	Set All Keys-Typematic/Make/Break

The HT82K628A will respond with ACK, clears its output buffer, sets all keys to the type indicated by this command, and continues scanning (if it was previously enabled). Although these commands can be sent using any code set, they affect only scan code set 3 operation.

FBH, FCH, FDH – Set key type

These commands instruct the HT82K628A to set individual keys to the type listed below:

Hex Value	Command
FB	Set Key Type-Typematic
FC	Set Key Type-Make/Break
FD	Set Key Type-Make

The HT82K628A will respond with ACK, clears its output buffer and prepares to receive key identification. Key identification is accomplished by the host identifying each key by its scan code value as defined in scan code set 3. Only scan code set 3 values are valid for key identification. The type of each identified key is set to the value indicated by the command. Although these commands can be sent using any code set, they affect only scan code set 3 operation.

FEH – Resend

The host sends this command when it detects an error in any transmission from the HT82K628A. It is sent only after a data transmission and before the host allows the next data output. When a Resend is received, the HT82K628A sends the previous output again (unless the previous output was Resend, in which case the HT82K628A sends the last byte before the Resend command).

Commands to the host

The following table shows the commands that the HT82K628A may send to the host, and their hexadecimal values.

Command	Hex Value
Key Detection Error/Overrun	00 (Code Set 2 and 3)
Keyboard ID	83AB
Bat Completion Code	AA
Bat Failure Core	FC
Echo	EE
Acknowledge	FA
Resend	FE
Key Detection Error/Overrun	FF (Code Set 1)

00H or FFH – Key detection error

The HT82K628A sends a key detection error character if conditions in the keyboard make it impossible to identify a switch closure. If the HT82K628A is using scan code set 1, the code is FFH. For sets 2 and 3, the code is 00H.

00H or FFH – Overrun

An overrun character is placed in the HT82K628A buffer and replaces the last code when the buffer capacity has been exceeded. The code is sent to the host when it reaches the top of the buffer queue. If the HT82K628A is using scan code set 1, the code is FFH. For sets 2 and 3, the code is 00H.

83AbH – Keyboard ID

The keyboard ID consists of 2 bytes, Hex 83AbH. The HT82K628A responds to the Read ID with ACK, discontinues scanning and sends 2 ID bytes. The low byte is sent first followed by the high byte. Following the output of Keyboard ID, the HT82K628A begins scanning.

EEH – Echo

The HT82K628A sends this code in response to an Echo command.

AAH – BAT completion code

Following satisfactory completion of the BAT, the HT82K628A sends AAH. Any other code indicates keyboard failure.

FCH – BAT failure code

If a BAT failure occurs, the HT82K628A sends this code, discontinues scanning and waits for a host response or reset.

FEH – Resend

The HT82K628A issues a Resend command following receipt of an invalid input or any input with incorrect parity. If the host sends nothing to the HT82K628A, no response is required.

Data communications

- Data output
 - ♦ If CLK=0, no transmission (keyboard is inhibited).
 - ♦ If CLK=1, DATA=0, no transmission (system request to send).
 - ♦ If CLK=1, DATA=1, transmission permitted.
 - ♦ Data will be valid before the trailing edge and beyond the leading edge of the clock.
 - ♦ The KB checks the clock line for an active level of at least every 60ms.
 - ♦ If line contention occurs (system brings the clock low before the tenth clock), set clock=data=high.
- Data input
 - ♦ The system overrides the clock line for at least 60ms.
 - ♦ The keyboard checks the clock line state at intervals of 10ms
 - ♦ If a system request-to-send is detected, the keyboard counts 11 data bits.
 - ♦ Data will be valid before the rising edge and beyond the falling edge
 - ♦ After the 10th bit, the keyboard checks for an active level on the "data" line. If the line is active it is forced to be inactive, and counts one more bit.

Note: This action signals the system that the keyboard has received its data. Upon reception of this signal, the system returns to the ready state, in which it can accept keyboard outputs or goes to the inhibit state until it is ready.

If the keyboard "data" line is found to be at an inactive level following the 10th bit, a frame error has occurred, and the keyboard continues to count until the "data" line becomes active. The keyboard then makes the "data" line inactive and sends a Resend.

Data stream

Mode 1,2,3	
B1:	start bit always 0
B2:	data bit 0
b3:	data bit 1
b4:	data bit 2
b5:	data bit 3
B6:	data bit 4
b7:	data bit 5
b8:	data bit 6
b9:	data bit 7
b10:	parity bit (odd par)
b11:	stop bit always 1

Note: The parity bit is either 1 or 0, and the 8 data bits, plus the parity bit, always have an odd number of 1µs.

Key code set 1

Key Number and Symbol			Make/Break Code	Key Number and Symbol		Make/Break Code
1	~	'	29/A9	47	X	2D/AD
2	!	1	02/82	48	C	2E/AE
3	@	2	03/83	49	V	2F/AF
4	#	3	04/84	50	B	30/B0
5	\$	4	05/85	51	N	31/B1
6	%	5	06/86	52	M	32/B2
7	^	6	07/87	53	< ,	33/B3
8	&	7	08/88	54	> .	34/B4
9	*	8	09/89	55	? /	35/B5
10	(9	0A/8A	57	Shift (R)	36/B6
11)	0	0B/8B	58	Ctrl (L)	1D/9D
12	_	-	0C/8C	60	Alt (L)	38/B8
13	+	=	0D/8D	61	Space	39/B9
14			56 7D/D6 FD	62	Alt (R)	E0 38/E0 B8
15	Back Space		0E/8E	64	Ctrl (R)	E0 1D/E0 9D
16	Tab		0F/8F	90	Num Lock	45/C5
17	Q		10/90	91	7 Home	47/C7
18	W		11/91	92	4 ←	4B/CB
19	E		12/92	93	1 End	4F/CF
20	R		13/93	96	8 ↑	48/C8
21	T		14/94	97	5	4C/CC
22	Y		15/95	98	2 ↓	50/D0
23	U		16/96	99	0 Ins	52/D2
24	I		17/97	100	*	37/B7
25	O		18/98	101	9 PgUp	49/C9
26	P		19/99	102	6 →	4D/CD
27	{	[1A/9A	103	3 PgDn	51/D1
28	}]	1B/9B	104	. Del	53/D3
*29		\	2B/AB	105	-	4A/CA

Key Number and Symbol		Make/Break Code	Key Number and Symbol		Make/Break Code
30	Caps Lock	3A/BA	106	+	4E/CE
31	A	1E/9E	107		7E/FE
32	S	1F/9F	108	Enter	E0 1C/E0 9C
33	D	20/A0	110	ESC	01/81
34	F	21/A1	112	F1	3B/BB
35	G	22/A2	113	F2	3C/BC
36	H	23/A3	114	F3	3D/BD
37	J	24/A4	115	F4	3E/BE
38	K	25/A5	116	F5	3F/BF
39	L	26/A6	117	F6	40/C0
40	:	27/A7	118	F7	41/C1
41		28/A8	119	F8	42/C2
**42		2B/AB	120	F9	43/C3
43	Enter	1C/9C	121	F10	44/C4
44	Shift (L)	2A/AA	122	F11	57/D7
**45	Macro	56/D6	123	F12	58/D8
46	Z	2C/AC	125	Scroll Lock	46/C6
*101-Key Keyboard Only					
**102-Key Keyboard Only					

Key Number and Symbol		Base Case Shift+Num	Left-Shift	Right-Shift	Num Lock
75	Insert	E0 52 /E0 D2	E0 AA E0 52 /E0 D2 E0 2A	E0 B6 E0 52 /E0 D2 E0 36	E0 2A E0 52 /E0 D2 E0 AA
76	Delete	E0 53 /E0 D3	E0 AA E0 53 /E0 D3 E0 2A	E0 B6 E0 53 /E0 D3 E0 36	E0 2A E0 53 /E0 D3 E0 AA
79	←	E0 4B /E0 CB	E0 AA E0 4B /E0 CB E0 2A	E0 B6 E0 4B /E0 CB E0 36	E0 2A E0 4B /E0 CB E0 AA
80	Home	E0 47 /E0 C7	E0 AA E0 47 /E0 C7 E0 2A	E0 B6 E0 47 /E0 C7 E0 36	E0 2A E0 47 /E0 C7 E0 AA
81	End	E0 4F /E0 CF	E0 AA E0 4F /E0 CF E0 2A	E0 B6 E0 4F /E0 CF E0 36	E0 2A E0 4F /E0 CF E0 AA
83	↑	E0 48 /E0 C8	E0 AA E0 48 /E0 C8 E0 2A	E0 B6 E0 48 /E0 C8 E0 36	E0 2A E0 48 /E0 C8 E0 AA
84	↓	E0 50 /E0 D0	E0 AA E0 50 /E0 D0 E0 2A	E0 B6 E0 50 /E0 D0 E0 36	E0 2A E0 50 /E0 D0 E0 AA
85	PgUp	E0 49 /E0 C9	E0 AA E0 49 /E0 C9 E0 2A	E0 B6 E0 49 /E0 C9 E0 36	E0 2A E0 49 /E0 C9 E0 AA
86	PgDn	E0 51 /E0 D1	E0 AA E0 51 /E0 D1 E0 2A	E0 B6 E0 51 /E0 D1 E0 36	E0 2A E0 51 /E0 D1 E0 AA
89	→	E0 4D /E0 CD	E0 AA E0 4D /E0 CD E0 2A	E0 B6 E0 4D /E0 CD E0 36	E0 2A E0 4D /E0 CD E0 AA
L Win		E0 5B /E0 DB	E0 AA E0 5B /E0 DB E0 2A	E0 B6 E0 5B /E0 DB E0 36	E0 2A E0 5B /E0 DB E0 AA
R Win		E0 5C /E0 DC	E0 AA E0 5C /E0 DC E0 2A	E0 B6 E0 5C /E0 DC E0 36	E0 2A E0 5C /E0 DC E0 AA
APP		E0 5D /E0 DD	E0 AA E0 5D /E0 DD E0 2A	E0 B6 E0 5D /E0 DD E0 36	E0 2A E0 5D /E0 DD E0 AA
When both shift keys are held down: key number 75			Both Shift E0 AA E0 B6 E0 52/E0 D2 E0 2A E0 36		

Key Number and Symbol		Base	Left-Shift	Right-Shift
95	/	E0 35/E0 B5	E0 AA E0 35/E0 B5 E0 2A	E0 B6 E0 35/E0 B5 E0 36
When both shift keys are held down: key number 95			Both Shift E0 AA E0 B6 E0 35/E0 B5 E0 2A E0 36	

Key Number and Symbol		Base	Shift/Ctrl	Alt
124	Print Screen	E0 2A E0 37/E0 B7 E0 AA	E0 37/E0 B7	54/D4

Key Number and Symbol		Base	Ctrl
126	Pause	E1 1D 45 E1 9D C5	E0 46 E0 C6

This key is not typematic, all associated scan codes occur on the make code.

Key Number and Function		Make/Break code	Default
ACPI	Power	E0 5E/E0 DE	Make/Break
ACPI	Sleep	E0 5F/E0 DF	Make/Break
ACPI	Wake-up	E0 63/E0 E3	Make/Break

Key Number and Function		Make/Break code	Default
56	Brazil BA0	73/F3	Typematic
131	Japanese J131	7B/FB	Make
132	Japanese J132	79/F9	Make
133	Japanese J133	70/F0	Make
150	Korea KC-L	F1/-	Make
151	Korea KC-R	F0/-	Make

Multimedia Key Function	Make/Break code
E-Mail	E0 6C/E0 EC
WWW Home	E0 32/E0 B2
WWW Favorites	E0 66/E0 E6
WWW Search	E065/E0 E5
WWW Refresh	E0 67/E0 E7
WWW Stop	E0 68/E0 E8
WWW Forward	E0 69/E0 E9
WWW Back	E0 6A/E0 EA
Media	E0 6D/E0 ED
Play/Pause	E0 22/E0 A2
Stop	E0 24/E0 A4
Prev Track	E0 10/E0 90
Next Track	E0 19/E0 99
Volume+	E0 30/E0 B0
Volume-	E0 2E/E0 AE
Mute	E0 20/E0 A0
My Computer	E0 6B/E0 EB
Calculator	E0 21/E0 A1
Screen save	E0 26/E0 A6
Rec	E0 1E/E0 9E
Rew	E0 17/E0 97
Minimize	E0 2D/E0 AD
Eject	E0 11/E0 91

Key code set 2

Key Number and Symbol			Make/Break Code	Key Number and Symbol		Make/Break Code
1	~	'	0E/F0 0E	47	X	22/F0 22
2	!	1	16/F0 16	48	C	21/F0 21
3	@	2	1E/F0 1E	49	V	2A/F0 2A
4	#	3	26/F0 26	50	B	32/F0 32
5	\$	4	25/F0 25	51	N	31/F0 31
6	%	5	2E/F0 2E	52	M	3A/F0 3A
7	^	6	36/F0 36	53	< ,	41/F0 41
8	&	7	3D/F0 3D	54	> .	49/F0 49
9	*	8	3E/F0 3E	55	? /	4A/F0 4A
10	(9	46/F0 46	57	Shift (R)	59/F0 59
11)	0	45/F0 45	58	Ctrl (L)	14/F0 14
12	_	-	4E/F0 4E	60	Alt (L)	11/F0 11
13	+	=	55/F0 55	61	Space	29/F0 29
14			6A/F0 6A	62	Alt (R)	E0 11/E0 F0 11
15	Back Space		66/F0 66	64	Ctrl (R)	E0 14/E0 E0 F0 14
16	Tab		0D/F0 0D	90	Num Lock	77/F0 77
17	Q		15/F0 15	91	7 Home	6C/F0 6C
18	W		1D/F0 1D	92	4 ←	6B/F0 6B
19	E		24/F0 24	93	1 End	69/F0 69
20	R		2D/F0 2D	96	8 ↑	75/F0 75
21	T		2C/F0 2C	97	5	73/F0 73
22	Y		35/F0 35	98	2 ↓	72/F0 72
23	U		3C/F0 3C	99	0 Ins	70/F0 70
24	I		43/F0 43	100	*	7C/F0 7C
25	O		44/F0 44	101	9 PgUp	7D/F0 7D
26	P		4D/F0 4D	102	6 →	74/ F0 74
27	{	[54/F0 54	103	3 PgDn	7A/ F0 7A
28	}]	5B/F0 5B	104	. Del	71/F0 71
*29		\	5D/F0 5D	105	-	7B/F0 7B
30	Caps Lock		58/F0 58	106	+	79/F0 79
31	A		1C/F0 1C	107		6D/F0 6D
32	S		1B/F0 1B	108	Enter	E0 5A/E0 F0 5A
33	D		23/F0 23	110	ESC	76/F0 76
34	F		2B/F0 2B	112	F1	05/F0 05
35	G		34/F0 34	113	F2	06/F0 06
36	H		33/F0 33	114	F3	04/F0 04
37	J		3B/F0 3B	115	F4	0C/F0 0C
38	K		42/F0 42	116	F5	03/F0 03
39	L		4B/F0 4B	117	F6	0B F0 0B

Key Number and Symbol			Make/Break Code	Key Number and Symbol			Make/Break Code
40	:	;	4C/F0 4C	118	F7	83/F0 83	
41			52/F0 52	119	F8	0A/F0 0A	
**42		\	5D/F0 5D	120	F9	01/F0 01	
43	Enter		5A/F0 5A	121	F10	09/F0 09	
44	Shift (L)		12/F0 12	122	F11	78/F0 78	
**45	Macro		61/F0 61	123	F12	07/F0 07	
46	Z		1A/F0 1A	125	Scroll Lock	7E/F0 7E	
*101-Key Keyboard Only							
**102-Key Keyboard Only							

Key Number and Symbol		Base Case Shift+Num	Left-Shift	Right-Shift	Num Lock
75	Insert	E0 70 /E0 F0 70	E0 F0 12 E0 70 /E0 F0 70 E0 12	E0 F0 59 E0 70 /E0 F0 70 E0 59	E0 12 E0 70 /E0 F0 70 E0 F0 12
76	Delete	E0 71 /E0 F0 71	E0 F0 12 E0 71 /E0 F0 71 E0 12	E0 F0 59 E0 71 /E0 F0 71 E0 59	E0 12 E0 71 /E0 F0 71 E0 F0 12
79	←	E0 6B /E0 F0 6B	E0 F0 12 E0 6B /E0 F0 6B E0 12	E0 F0 59 E0 6B /E0 F0 6B E0 59	E0 12 E0 6B /E0 F0 6B E0 F0 12
80	Home	E0 6C /E0 F0 6C	E0 F0 12 E0 6C /E0 F0 6C E0 12	E0 F0 59 E0 6C /E0 F0 6C E0 59	E0 12 E0 6C /E0 F0 6C E0 F0 12
81	End	E0 69 /E0 F0 69	E0 F0 12 E0 69 /E0 F0 69 E0 12	E0 F0 59 E0 69 /E0 F0 69 E0 59	E0 12 E0 69 /E0 F0 69 E0 F0 12
83	↑	E0 75 /E0 F0 75	E0 F0 12 E0 75 /E0 F0 75 E0 12	E0 F0 59 E0 75 /E0 F0 75 E0 59	E0 12 E0 75 /E0 F0 75 E0 F0 12
84	↓	E0 72 /E0 F0 72	E0 F0 12 E0 72 /E0 F0 72 E0 12	E0 F0 59 E0 72 /E0 F0 72 E0 59	E0 12 E0 72 /E0 F0 72 E0 F0 12
85	PgUp	E0 7D /E0 F0 7D	E0 F0 12 E0 7D /E0 F0 7D E0 12	E0 F0 59 E0 7D /E0 F0 7D E0 59	E0 12 E0 7D /E0 F0 7D E0 F0 12
86	PgDn	E0 7A /E0 F0 7A	E0 F0 12 E0 7A /E0 F0 7A E0 12	E0 F0 59 E0 7A /E0 F0 7A E0 59	E0 12 E0 7A /E0 F0 7A E0 F0 12
89	→	E0 74 /E0 F0 74	E0 F0 12 E0 74 /E0 F0 74 E0 12	E0 F0 59 E0 74 /E0 F0 74 E0 59	E0 12 E0 74 /E0 F0 74 E0 F0 12
L Win		E0 1F	E0 F0 12 E0 1F	E0 F0 59 E0 1F	E0 12 E0 1F
		/E0 F0 1F	/E0 F0 1F E0 12	/E0 F0 1F E0 59	/E0 F0 1F E0 F0 12
R Win		E0 27	E0 F0 12 E0 27	E0 F0 59 E0 27	E0 12 E0 27
		/E0 F0 27	/E0 F0 27 E0 12	/E0 F0 27 E0 59	/E0 F0 27 E0 F0 12
APP		E0 2F	E0 F0 12 E0 2F	E0 F0 59 E0 2F	E0 12 E0 2F
		/E0 F0 2F	/E0 F0 2F E0 12	/E0 F0 2F E059	/E0 F0 2F E0 F0 12
When both shift keys are held down: key number 75			Both Shift E0 AA E0 B6 E0 52/E0 D2 E0 2A E0 36		

Key Number and Symbol		Base	Left-Shift	Right-Shift
95	/	E0 4A/E0 F0 4A	E0 F0 12 E0 4A/E0 F0 4A E0 12	E0 F0 59 E0 4A/E0 F0 4A E0 59
When both shift keys are held down: key number 95			Both Shift E0 F0 12 E0 F0 59 E0 4A/E0 F0 4A E0 12 E0 59	

Key Number and Symbol		Base	Shift/Ctrl	Alt
124	Print Screen	E0 12 E0 7C/E0 F0 7C E0 F0 12	E0 7C/E0 F0 7C	84/F0 84

Key Number and Symbol		Base	Ctrl
126	Pause	E1 14 77 E1 F0 14 F0 77	
E0 7E E0 F0 7E			
This key is not typematic, all associated scan codes occur on the make code.			

Key Number and Function		Make/Break code	Default
ACPI	Power	E0 37/E0 F0 37	Make/Break
ACPI	Sleep	E0 3F/E0 F0 3F	Make/Break
ACPI	Wake-up	E0 5E/E0 F0 5E	Make/Break

Key Number and Function		Make/Break code	Default
56	Brazil BA0	51/F0 51	Typematic
131	Japanese J131	67/F0 67	Make
132	Japanese J132	64/F0 64	Make
133	Japanese J133	13/F0 13	Make
150	Korea KC-L	F1/-	Make
151	Korea KC-R	F2/-	Make

Multimedia Key Function	Make/Break code
E-Mail	E0 48/E0 F0 48
WWW Home	E0 3A/E0 F0 3A
WWW Favorites	E0 18/E0 F0 18
WWW Search	E0 10/E0 F0 10
WWW Refresh	E0 20/E0 F0 20
WWW Stop	E0 28/E0 F0 28
WWW Forward	E0 30/E0 F0 30
WWW Back	E0 38/E0 F0 38
Media	E0 50/E0 F0 50
Play/Pause	E0 34/E0 F0 34
Stop	E0 3B/E0 F0 3B
Prev Track	E0 15/E0 F0 15
Next Track	E0 4D/E0 F0 4D
Volume+	E0 32/E0 F0 32
Volume-	E0 21/E0 F0 21
Mute	E0 23/E0 F0 23
My Computer	E0 40/E0 F0 40
Calculator	E0 2B/E0 F0 2B
Screen save	E0 4B/E0 F0 4B
Rec	E0 1C/E0 F0 1C
Rew	E0 43/E0 F0 43
Minimize	E0 22/E0 F0 22
Eject	E0 1D/E0 F0 1D

Key code set 3

Key Number	Make /Break Code	Default Key State	Key Number	Make /Break Code	Default Key State
1	0E/F0 0E	Typematic	55	4A/F0 4A	Typematic
2	16/F0 16	Typematic	57	59/F0 59	Make/Break
3	1E/F0 1E	Typematic	58	11/F0 11	Make/Break
4	26/F0 26	Typematic	59	8B/F0 8B	Make/Break
5	25/F0 25	Typematic	60	19/F0 19	Make/Break
6	2E/F0 2E	Typematic	61	29/F0 29	Typematic
7	36/F0 36	Typematic	62	39/F0 39	Make Only
8	3D/F0 3D	Typematic	63	8C/F0 8C	Make/Break
9	3E/F0 3E	Typematic	64	58/F0 58	Make Only
10	46/F0 46	Typematic	75	67/F0 67	Make Only
11	45/F0 45	Typematic	76	64/F0 64	Typematic
12	4E/F0 4E	Typematic	79	61/F0 61	Typematic
13	55/F0 55	Typematic	80	6E/F0 6E	Make Only
14	5D/F0 5D	Typematic	81	65/F0 65	Make Only
15	66/F0 66	Typematic	83	63/F0 63	Typematic
16	0D /F0 0D	Typematic	84	60/F0 60	Typematic
17	15/F0 15	Typematic	85	6F/F0 6F	Make Only
18	1D/F0 1D	Typematic	86	6D/F0 6D	Make Only
19	24/F0 24	Typematic	89	6A/F0 6A	Typematic
20	2D/F0 2D	Typematic	90	76/F0 76	Make Only
21	2C/F0 2C	Typematic	91	6C/F0 6C	Make Only
22	35/F0 35	Typematic	92	6B/F0 6B	Make Only
23	3C/F0 3C	Typematic	93	69/F0 69	Make Only
24	43/F0 43	Typematic	95	77/F0 77	Make Only
25	44/F0 44	Typematic	96	75/F0 75	Make Only
26	4D/F0 4D	Typematic	97	73/F0 73	Make Only
27	54/F0 54	Typematic	98	72/F0 72	Make Only
28	5B/F0 5B	Typematic	99	70/F0 70	Make Only
*29	5C/F0 5C	Typematic	100	7E/F0 7E	Make Only
30	14/F0 14	Make/Break	101	7D/F0 7D	Make Only
31	1C/F0 1C	Typematic	102	74/F0 74	Make Only
32	1B/F0 1B	Typematic	103	7A/F0 7A	Make Only
33	23/F0 23	Typematic	104	71/F0 71	Make Only
34	2B/F0 2B	Typematic	105	84/F0 84	Make Only
35	34/F0 34	Typematic	106	7C/F0 7C	Typematic
36	33/F0 33	Typematic	107	7B/F0 7B	Make Only
37	3B/F0 3B	Typematic	108	79/F0 79	Make Only
38	42/F0 42	Typematic	110	08/F0 08	Make Only
39	4B/F0 4B	Typematic	112	07/F0 07	Make Only
40	4C/F0 4C	Typematic	113	0F/F0 0F	Make Only
41	52/F0 52	Typematic	114	17/F0 17	Make Only
**42	53/F0 53	Typematic	115	1F/F0 1F	Make Only
43	5A/F0 5A	Typematic	116	27/F0 27	Make Only
44	12/F0 12	Make/Break	117	2F/F0 2F	Make Only
**45	13/F0 13	Typematic	118	37/F0 37	Make Only
46	1A/F0 1A	Typematic	119	3F/F0 3F	Make Only
47	22/F0 22	Typematic	120	47/F0 47	Make Only
48	21/F0 21	Typematic	121	4F/F0 4F	Make Only
49	2A/F0 2A	Typematic	122	56/F0 56	Make Only
50	32/F0 32	Typematic	123	5E/F0 5E	Make Only
51	31/F0 31	Typematic	124	57/F0 57	Make Only
52	3A/F0 3A	Typematic	125	5F/F0 5F	Make Only
53	41/F0 41	Typematic	126	62/F0 62	Make Only
54	49/F0 49	Typematic	127	8D/F0 8D	Typematic
*101-Key Keyboard Only					
**102-Key Keyboard Only					

Key Number and Function		Make/Break code	Default
56	Brazil BA0	51/F0 51	Typematic
131	Japanese J131	67/F0 67	Make
132	Japanese J132	64/F0 64	Make
133	Japanese J133	13/F0 13	Make
150	Korea KC-L	F1/-	Make
151	Korea KC-R	F2/-	Make

Timing Diagrams

Data output

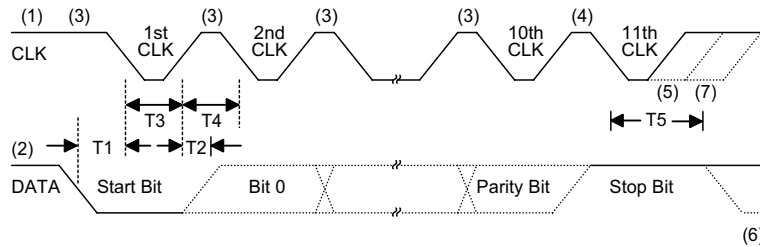

Timing Parameter	Min/Max
T1 DATA transition to the falling edge of CLK	5/25 μ sec
T2 Rising edge of CLK to DATA transition	5/T4-5 μ sec
T3 Duration of CLK inactive	30/50 μ sec
T4 Duration of CLK active	30/50 μ sec
T5 Time to auxiliary device inhibit after clock 11 to ensure the auxiliary device does not start another transmission	>0/50 μ sec



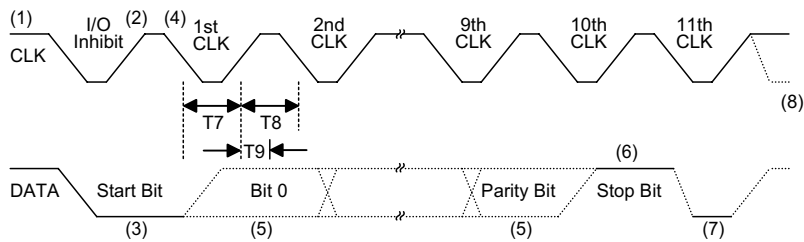



Keyboard data input



Timing Parameter	Min/Max
T7 Duration of CLK inactive	30/50 μ sec
T8 Duration of CLK active	30/50 μ sec
T9 Time from inactive to active CLK transition, used to time when the auxiliary device samples DATA	5/25 μ sec

Mini keyboard operation manual

• Macro key

- ♦  Open Old File
Should send <Ctrl>+<O> to system when pressed.
- ♦  SAVE
Should send <Ctrl>+<S> to system when pressed.
- ♦  PRINT
Should send <Ctrl>+<P> to system when pressed.
- ♦  CUT
Should send <Ctrl>+<X> to system when pressed.
- ♦  COPY
Should send <Ctrl>+<C> to system when pressed.
- ♦  PASTE
Should send <Ctrl>+<V> to system when pressed.
- ♦  Rotate Window
Press this key to switch the activated task window. Should send <Alt>+<Tab> to system when pressed.
- ♦ Close Window
Press this key to close the window. Should send <Alt>+<F4> to system when pressed.

• Fn key usage

Key Location	Status							
	Fn	Num Lock	Fn	Num Lock	Fn	Num Lock	Fn	Num Lock
	OFF	OFF	ON	OFF	OFF	ON	ON	ON
7	&7		Home		7		7	
8	*8		↑		8		8	
9	(9		PgUp		9		9	
0)0		*		*		0	
U	U		←		4		U	
I	I				5		I	
O	O		→		6		O	
P	P		-		-		P	
J	J		End		1		J	
K	K		↓		2		K	
L	L		PgDn		3		L	
::	::		+		+		::	
M	M		Ins		0		M	
>.	>.		Del		.		>.	
?/	?/		/		/		?/	
Enter	Enter (L)		Enter(R)		Enter(R)		Enter(L)	
F1/F11	F1		F11		F1		F11	
F2/F12	F2		F12		F2		F12	
F10/ ScrLock	F10		ScrLock		F10		ScrLock	
↑/PgUp	↑		Page Up		↑		Page Up	
↓/PgDn	↓		Page Down		↓		Page Down	
←/Home	←		Home		←		Home	
→/End	→		End		→		End	

Key matrix

	C0	C1	C2	C3	C4	C5	C6	C7
R0	PAUSE 126	Pre Track	Stop	Play/Pause	CTRL-R 64	Next Track	CTRL-L 58	F5 116
R1	Q 17	TAB 16	A 31	ESC 110	Z 46	N-CHG 131	'(~) 1	1(!) 2
R2	W 18	CAPS LOCK 30	S 32	(\) 45	X 47	CHG 132	F1 112	2(@) 3
R3	E 19	F3 114	D 33	F4 115	C 48	ROMA 133	F2 113	3(#) 4
R4	R 20	T 21	F 34	G 35	V 49	B 50	5(%) 6	4(\$) 5
R5	U 23	Y 22	J 37	H 36	M 52	N 51	6(^) 7	7(&) 8
R6	I 24]}) 28	K 38	F6 117	,(<) 53	\(-) 56	=(+) 13	8(* 9
R7	O 25	F7 118	L 39	Ctrl(R)+O	,(>) 54	APP	F8 119	9('') 10
R8	P 26	[({) 27	:(:) 40	'(") 41	()\br/>42	/(?) 55	_(-) 12	0('') 11
R9	SCROLL LOCK 125	Alt(R)+F4	Vol-	ALT-L 60	Vol+	ALT-R 62	Mute	PRINT SCREEN
R10	()\br/>14	BACK 15	\()\br/>29	F11 122	ENTER-L 43	F12 123	F9 120	F10 121
R11	7(Home) 91	4(←) 92	1(End) 93	SPACE 61	NUM LOCK 90	↓ 84	DEL 76	POWER
R12	8(↑) 96	5 97	2(↓) 98	0(Ins) 99	/ 95	→ 89	INS 75	SLEEP
R13	9(PgUp) 101	6(→) 102	3(PgDn) 103	,(Del) 104	* 100	- 105	PgUp 85	PgDn 86
R14	+ 106	. 107	ENTER-R 108	↑ 83	Ctrl(R)+X	← 79	HOME 80	END 81
R15	Wake-up	SHIFT-L 44	SHIFT-R 57	WWW Search	Alt(R)+Tab	Ctrl(R)+P	F1/F11	FN
R16	Screen Save	WIN-L	Ctrl(R)+C	Rec	Rew	Min	Eject	F10/ Scroll
R17	KC-L 150	Ctrl(R)+V	WIN-R	00	000	Ctrl(R)+S	F2/F12	KC-R 151
R18	Media	E-mail	WWW Home	WWW Back	WWW Forward	WWW Stop	WWW Refresh	WWW Bkmk
R19	My Computer	Calculator	↑/ Page Up	↓/ Page Down	←/ Home	→/ END		

Application Circuits

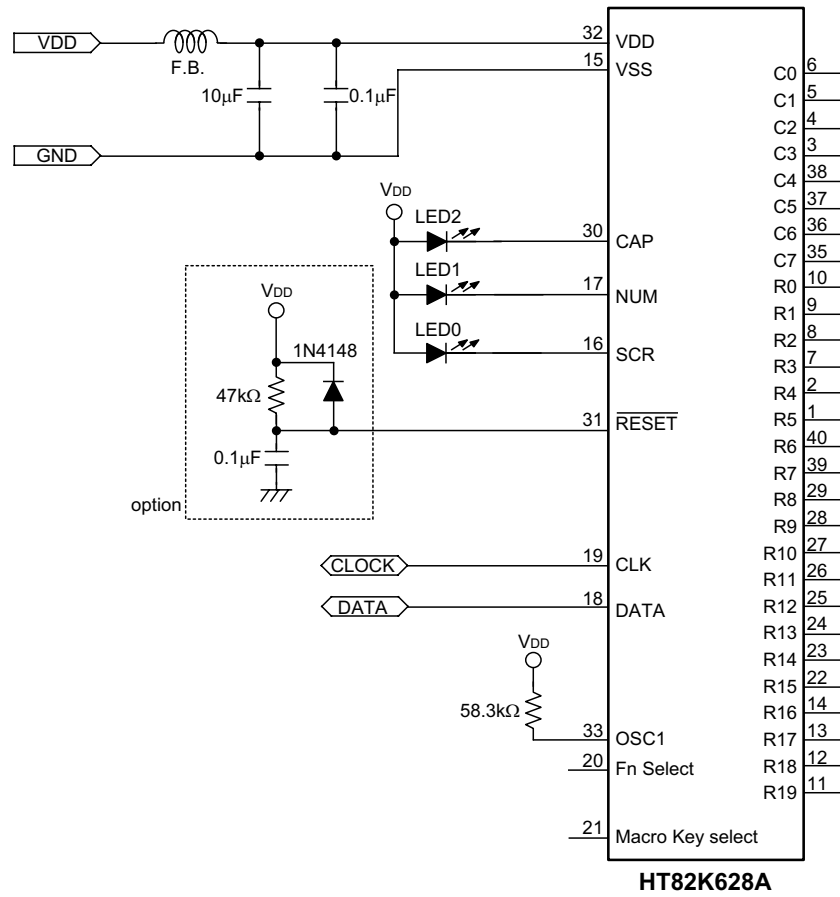

Note: Fn Select → GND: Enable the Mini Keyboard
 Macro Key Select → GND: Disable the Macro Key

Package Information

40-pin DIP (600mil) outline dimensions

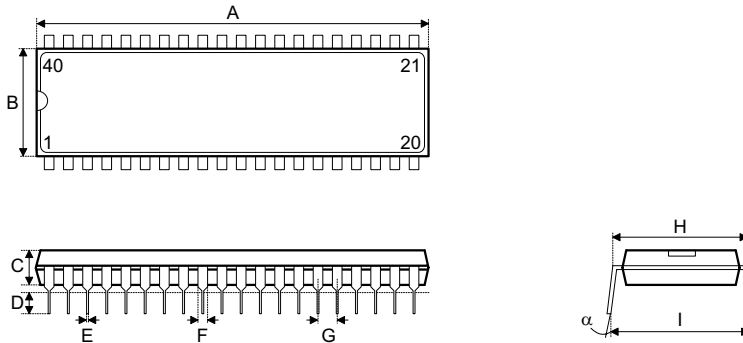

Symbol	Dimensions in mil		
	Min.	Nom.	Max.
A	2045	—	2065
B	535	—	555
C	145	—	155
D	125	—	145
E	16	—	20
F	50	—	70
G	—	100	—
H	595	—	615
I	635	—	670
α	0°	—	15°

Holtek Semiconductor Inc. (Headquarters)

No.3, Creation Rd. II, Science-based Industrial Park, Hsinchu, Taiwan
Tel: 886-3-563-1999
Fax: 886-3-563-1189
<http://www.holtek.com.tw>

Holtek Semiconductor Inc. (Sales Office)

11F, No.576, Sec.7 Chung Hsiao E. Rd., Taipei, Taiwan
Tel: 886-2-2782-9635
Fax: 886-2-2782-9636
Fax: 886-2-2782-7128 (International sales hotline)

Holtek Semiconductor (Shanghai) Inc.

7th Floor, Building 2, No.889, Yi Shan Rd., Shanghai, China
Tel: 021-6485-5560
Fax: 021-6485-0313
<http://www.holtek.com.cn>

Holtek Semiconductor (Hong Kong) Ltd.

RM.711, Tower 2, Cheung Sha Wan Plaza, 833 Cheung Sha Wan Rd., Kowloon, Hong Kong
Tel: 852-2-745-8288
Fax: 852-2-742-8657

Holmate Semiconductor, Inc.

48531 Warm Springs Boulevard, Suite 413, Fremont, CA 94539
Tel: 510-252-9880
Fax: 510-252-9885
<http://www.holmate.com>

Copyright © 2002 by HOLTEK SEMICONDUCTOR INC.

The information appearing in this Data Sheet is believed to be accurate at the time of publication. However, Holtek assumes no responsibility arising from the use of the specifications described. The applications mentioned herein are used solely for the purpose of illustration and Holtek makes no warranty or representation that such applications will be suitable without further modification, nor recommends the use of its products for application that may present a risk to human life due to malfunction or otherwise. Holtek reserves the right to alter its products without prior notification. For the most up-to-date information, please visit our web site at <http://www.holtek.com.tw>.