

# HSDL-4260

High-Power T-1 $\frac{3}{4}$  (5mm) AlGaAs Infrared (875nm) Lamp



## Datasheet

### Description

The HSDL-4260 High Power Infrared emitter was designed for applications that require high power, low forward voltage and high speed. It utilizes Aluminum Gallium Arsenide (AlGaAs) LED technology and is optimized for speed and efficiency at emission wavelengths of 875nm. The material used produces high radiant efficiency over a wide range of currents. The emitter is packaged in clear T-1 $\frac{3}{4}$  (5mm) package.

### Features

- High Power AlGaAs LED Technology
- 875nm Wavelength
- T-1 $\frac{3}{4}$  Package
- Low Cost
- Low Forward Voltage: 1.4V at 20mA
- High Speed: 15ns Rise Times

### Applications

- Industrial Infrared Equipments and applications
- Portable Infrared Instruments
- Consumer Electronics (Optical mouse, Infrared Remote Controllers etc)
- High Speed Infrared Communications (IR LANs, IR Modems, IR Dongles etc)

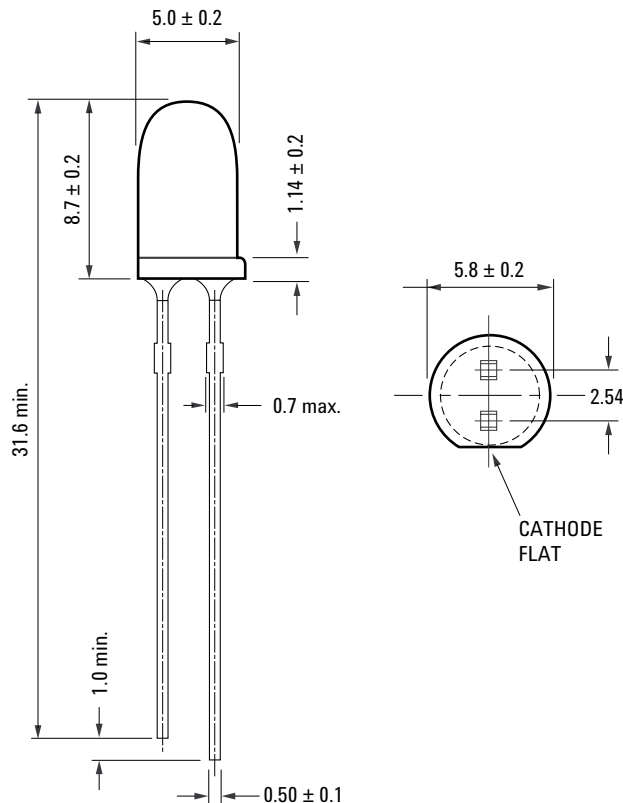

Part Number	Lead Form	Shipping Option
HSDL-4260	Straight	Bulk

**Absolute Maximum Ratings at 25°C**

Parameter	Symbol	Minimum	Maximum	Unit	Reference
Peak Forward Current	$I_{FPK}$	-	500	mA	Figure 3 Duty cycle = 20% Pulse Width = 100us
Forward Current	$I_{FDC}$	-	100	mA	[1]
Power Dissipation	$P_{DISS}$	-	230	mW	
Reverse Voltage	$V_R$	4	-	V	$I_R=100\mu A$
Storage Temperature	$T_S$	-40	100	°C	
LED Junction Temperature	$T_J$		110	°C	
Lead Soldering Temperature			260 for 5 sec	°C	

Notes: Derate as shown in Figure 6.

**Recommended Operating Conditions**

Parameter	Symbol	Min	Max	Unit	Reference
Operating Temperature	$T_0$	-40	85	°C	

**Electrical Characteristics at 25°C**

Parameter	Symbol	Min.	Typ.	Max.	Unit	Condition	Reference
Forward Voltage	$V_F$	-	1.4 1.7	1.9 2.3	V	$I_{FDC}=20mA$ $I_{FDC}=100mA$	Figure 2
Forward Voltage Temperature Coefficient	$\Delta V/\Delta T$	-	-1.3	-	mV/°C	$I_{FDC}=100mA$	Figure 4
Series Resistance	$R_S$	-	4	-	Ohms	$I_{FDC}=100mA$	
Diode Capacitance	$C_0$	-	70	-	pF	$V_{bias}=0V,$ $f=1MHz$	
Thermal Resistance, Junction to Ambient	$R\theta_{ja}$	-	300	-	°C/W		

**Optical Characteristics at 25°C**

Parameter	Symbol	Min.	Typ.	Max.	Unit	Condition	Reference
Radiant On-Axis Intensity	$I_E$	150	200	-	mW/Sr	$I_{FDC}=100mA$	Figure 5
Radiant On-Axis Intensity Temperature Coefficient	$\Delta I_E/\Delta T$	-	-0.36	-	%/°C	$I_{FDC}=100mA$	
Viewing Angle	$2\theta_{1/2}$	-	15	-	°		Figure 7
Peak Wavelength	$\lambda_{pk}$	-	875	-	nm		Figure 1
Peak wavelength Temperature Coefficient	$\Delta\lambda/\Delta T$	-	0.2	-	nm/°C	$I_{FDC}=100mA$	
Spectral Width	$\Delta\lambda$		45	-	nm	$I_{FDC}=20mA$	Figure 1
Optical Rise and Fall Time	$t_r/t_f$		15	-	ns	$I_{FDC}=500mA$ Duty Ratio = 20% Pulse Width=100ns	

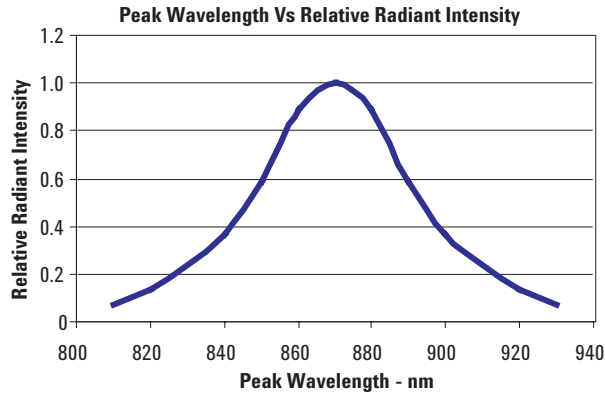

Figure 1. Relative Radiant Intensity vs. Wavelength

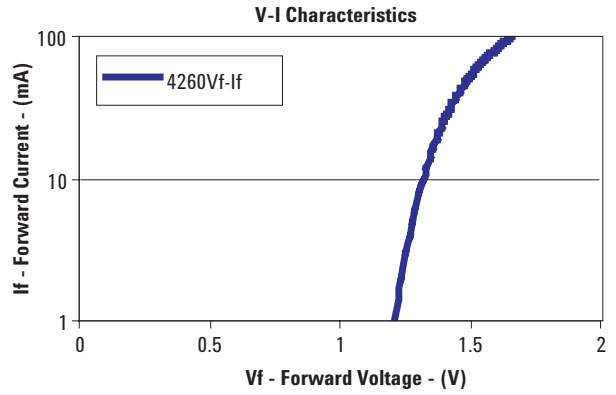

Figure 2. DC Forward Current vs. Forward Voltage

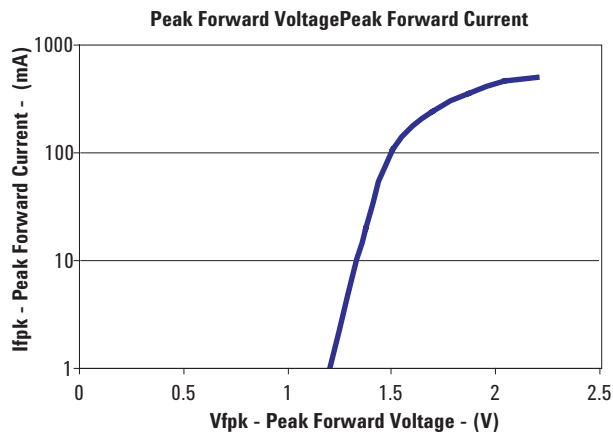

Figure 3. Peak Forward Current vs. Forward Voltage

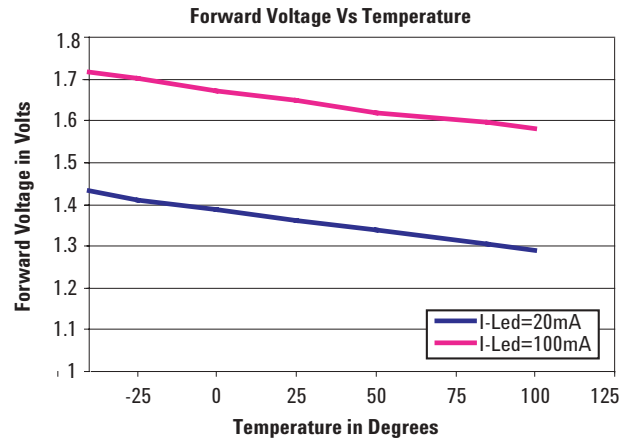

Figure 4. Forward Voltage vs. Ambient Temperature

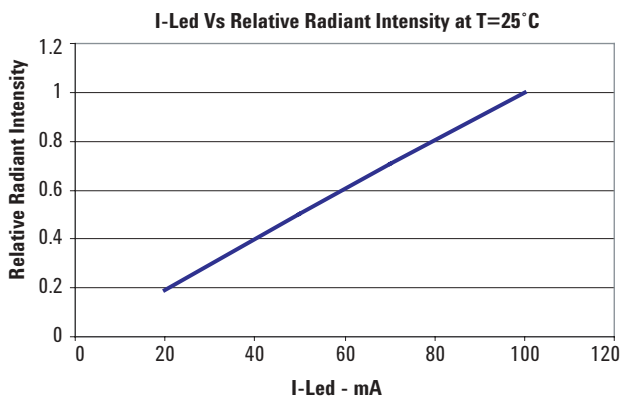

Figure 5. Relative Radiant Intensity vs. DC Forward Current

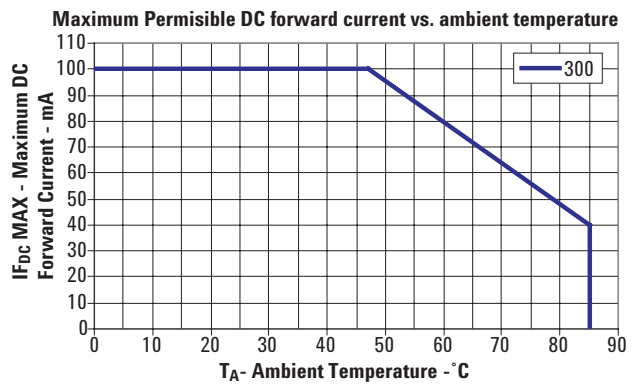

Figure 6. DC Forward Current vs. Ambient Temperature Derated Based on  $T_{JMAX}=110^{\circ}C$

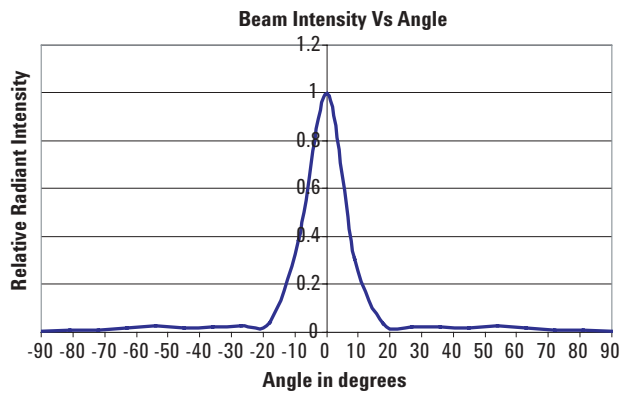
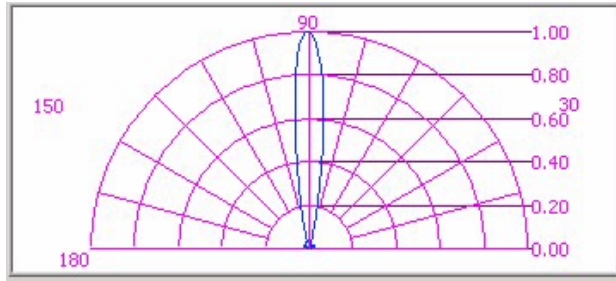

Figure 7. Radiant Intensity vs. Angular Displacement for HSDL-4260

For product information and a complete list of distributors, please go to our web site: [www.avagotech.com](http://www.avagotech.com)

Avago, Avago Technologies, and the A logo are trademarks of Avago Technologies, Pte. in the United States and other countries. Data subject to change. Copyright © 2006 Avago Technologies Pte. All rights reserved.  
5989-4468EN - January3, 2006

