

Request For Quotation

Order the parts you need from our real-time inventory database. Simply complete a request for quotation form with your part information and a sales representative will respond to you with price and availability.

[Request For Quotation](#)

Your free datasheet starts on the next page.

More datasheets and data books are available from our homepage: <http://www.datasheetarchive.com>

IrDA Infrared Communication Module

RPM873

RPM873 is an infrared communication module for IrDA Ver. 1.2 (Low Power). The infrared LED, PIN photo diode, and LSI are all integrated into one single package. This module is designed for low power consumption. The very small package makes it a perfect fit for mobile devices.

●Features

- 1) Infrared LED, PIN photo diode, LED driver and built-in receiver frequency formation circuit.
- 2) Applied to SIR (2.4 to 115.2kbps) low power standard.
- 3) Supply voltage range is from $V_{CC}=2.0$ to 3.6V, $V_{LEDA}=2.6$ to 5.5V.
- 4) Surface mounting type.
- 5) Built-in power down function.

●Applications

Cellular phones, PDA, DVC, digital still cameras, printers, handy terminals and etc.

●Absolute maximum ratings (Ta=25°C)

Parameter	Symbol	Limits	Unit
Supply voltage	V_{CC}/V_{LEDA}	7.0 *1	V
Input voltage	$V_{in}(5,6,7pin)$	-0.3 to $V_{CC}+0.3$	V
Operation temperature	T_{opr}	-25 to 85	°C
Storage temperature	T_{stg}	-30 to 100	°C
Power dissipation	P_d	100 *2	mW

*1) This applies to all pins on the basis of ground pins (1,4pin).

*2) In case of operating environment is over 25°C, 1.33mW would be reduced per each 1°C stepping up.

●Recommended operating conditions (Ta=25°C)

Parameter	Symbol	Min.	Typ.	Max.	Units
Supply voltage	V_{CC}	2.0	3.0	3.6	V
	V_{LEDA}	2.6	3.0	5.5	V

Photo Link Module

●Block diagram and application circuit

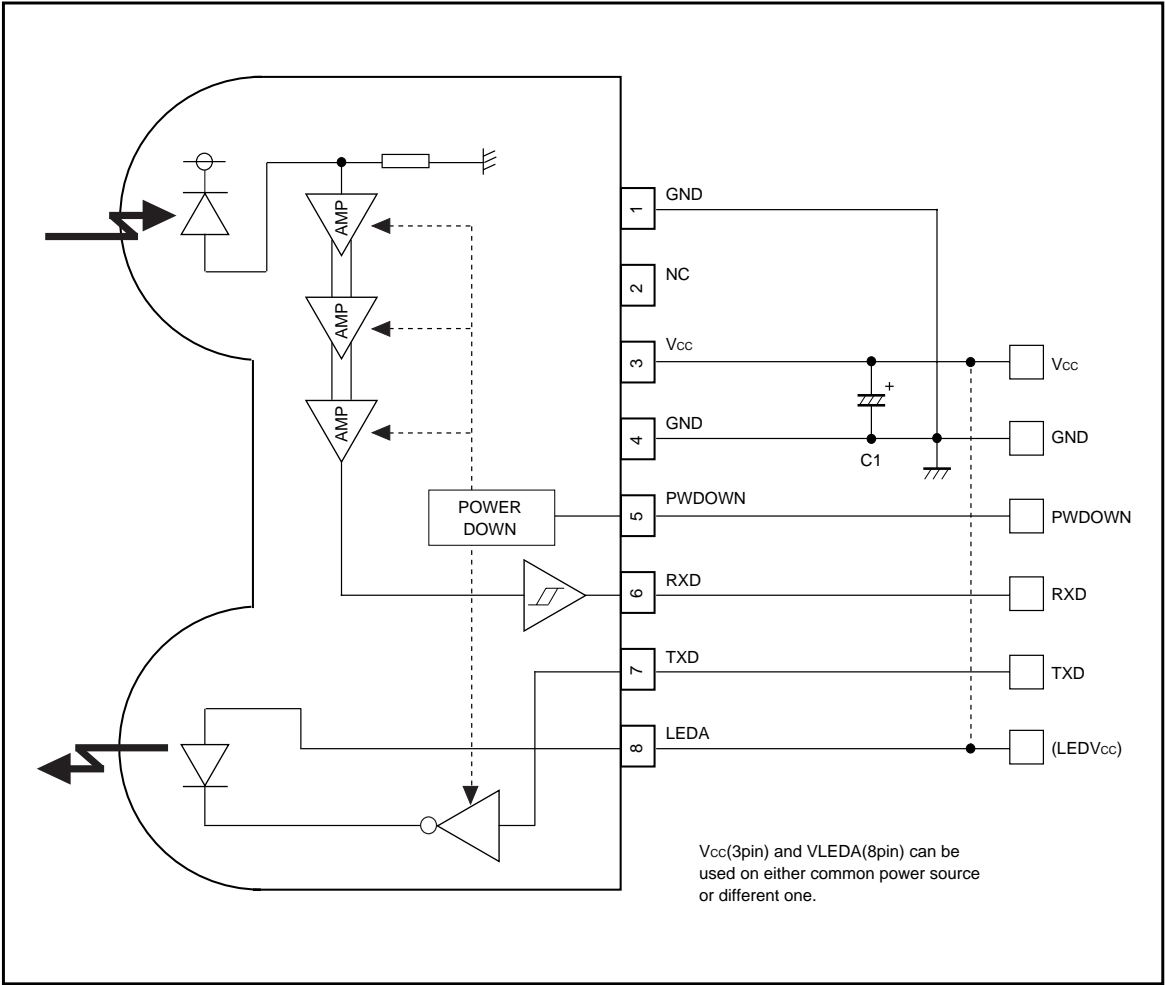

●Recommended values

Part symbol	Recommended	Notice
C1	1μF, tantalum or ceramic Ex.) TCFGA1A105M8R(ROHM)	Bigger capacitance is recommended with much noise from power supply.

Photo Link Module

●Terminal description

Pin No.	Terminal	Circuit	Function
1	GND		GND
2	NC		This terminal must be left open.
3	Vcc		Vcc For preventing from infection, connect a capacitor between Vcc(3pin) and GND(4pin).
4	GND		GND
5	PWDOWN		Power-down control terminal H : Power down L : Operation CMOS logic level input When input is H, it will stop the receiving circuit, PIN-PD current and transmitting LED operation.
6	RXD		Receiving data output terminal CMOS logic level output When PWDOWN (5pin) = H, the RXD output will be pulled up to Vcc at approximately 300kΩ.
7	TXD		Transmitting data input terminal H : LED (PWDOWN = L) CMOS logic level input Holding TXD = H status, LED will be turned off at approximately 48μs.
8	LEDA		LED ANODE terminal Other power source can be used difference between VLEDA and Vcc. This can be connected to battery kinds of unregulated voltage source by internal constant current driver.

Photo Link Module

●Electrical characteristics ($V_{CC}=3V$, $V_{LEDA}=3V$, $T_a=25^{\circ}C$)

Parameter	Symbol	Min.	Typ.	Max.	Unit	Conditions
Consumption current 1	I _{cc1}	–	75	99	μA	Waiting mode, At no input light
Consumption current 2	I _{cc2}	–	0.01	0.2	μA	PWDOWN mode, At no input light
Transmission rate		2.4	–	115.2	kbps	
PWDOWN input high voltage	V _{PDH}	$V_{CC}-0.55$	–	–	V	
PWDOWN input low voltage	V _{PDL}	0	–	0.55	V	
PWDOWN input high current	I _{PDH}	–1.0	0	1.0	μA	PWDOWN= V_{CC} [V]
PWDOWN input low current	I _{PDL}	–1.0	0	1.0	μA	PWDOWN=0 [V]
<Transmitter>						
TXD input high voltage	V _{TXH}	$V_{CC}-0.55$	–	–	V	
TXD input low voltage	V _{TXL}	0	–	0.55	V	
TXD input high current	I _{TXH}	2.5	5	10	μA	TXD= V_{CC} [V]
TXD input low current	I _{TXL}	–1.0	0	1.0	μA	TXD=0 [V]
LED anode current	I _{LEDA}	–	30.5	–	mA	
<Receiver>						
RXD output high voltage	V _{RXH}	$V_{CC}-0.4$	–	–	V	I _{RXH} = –200μA
RXD output low voltage	V _{RXL}	0	–	0.4	V	I _{RXL} = 200μA
RXD output rise time	t _{RR}	–	35	–	ns	C _L =15pF
RXD output fall time	t _{FR}	–	35	–	ns	C _L =15pF
RXD output pulse width	t _{wRXD}	1.5	2.3	4.2	μs	C _L =15pF, 2.4 to 115.2kbps
Receiver latency time	t _{RT}	–	100	200	μs	

●Optical characteristics ($V_{CC}=3V$, $V_{LEDA}=3V$, $T_a=25^{\circ}C$)

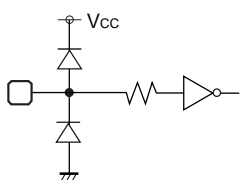
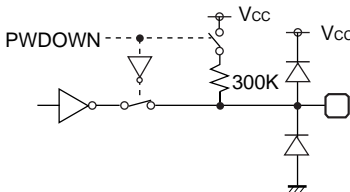
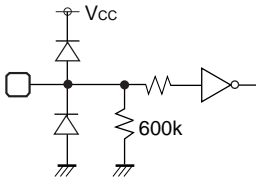
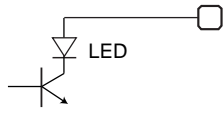
Parameter	Symbol	Min.	Typ.	Max.	Unit	Conditions
Peak wave length	λ _P	850	870	900	nm	
Intensity 1	I _{E1}	4	10	26	mW / Sr	–15° ≤ θ _L ≤ 15°
Half-angle	θ _L / 2	–	±18	±30	°	
Opticcal pulse width	T _{WLED}	1.42	1.63	2.02	μs	TXD=1.63μs pulse input
Rise time / Fall time	T _r / T _f	–	–	100	ns	10% to 90%
Optical over shoot		–	–	25	%	
Edge jitter	T _j	–40	–	40	ns	
Minimum irradiance in angular range	E _{emin}	–	–	6.8	μW / cm ²	–15° ≤ θ _L ≤ 15°
Maximum irradiance in angular range	E _{emax}	500	–	–	mW / cm ²	–15° ≤ θ _L ≤ 15°
Half-angle	θ _D / 2	±15	–	–	°	
Maximum emitting time	T _{LEDmax}	10	48	120	μs	TXD= V_{CC}

1. This product is not designed for protection against radioactive rays.

2. This product does not include laser transmitter.

3. This product include one PIN photo diode.

4. This product dose not include optical load.

Photo Link Module

●Timing chart

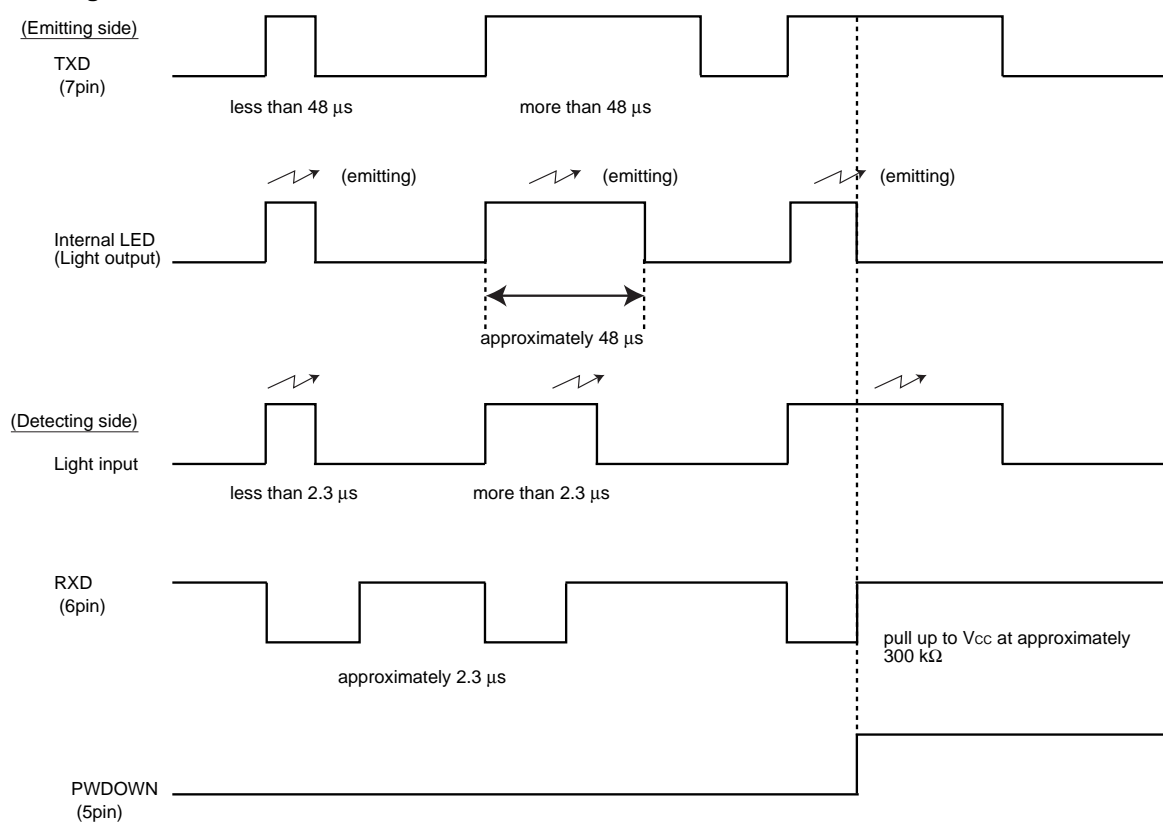

●Notes

1) VLEDA (8pin) and V_{CC} (3pin)

- Other power source can be used difference between VLEDA and V_{CC}.

2) Caution in designing board lay-out

To get maximum potential from RPM873, please keep in mind following instruction.

- The line of RXD (6pin) should be connected at backside via through hole close to RPM873 pin lead. Better not to be close to photo diode side (1pin).
⇒This is to minimize feedback supplied to photo diode from RXD.
- Better to be placed more than 1.0cm in radius from photo diode (pin1 side) and also away from the parts which generate noise, such as DC / DC converter.
- As for C1 between 3-4pin should be placed close to RPM873.

3) Notes

- Please be sure to set up the TXD (7pin) input to be "L" (under 0.55V) except transmitting data (for $90\mu\text{s}$, ON duty <math><20\%</math>)
- Power down current might increase if exposed by strong light (ex. direct sunlight) at power down mode.
- Please use by the signal format which is specified by IrDA Ver1.2 (2.4k to 115.2kbps). There might be on error if used by different signal format.

4) Eye Safe

- IEC825-1 (EN60825-1) Class 1 Eye Safe.

Photo Link Module

● Dimensions Diagram (Unit : mm)

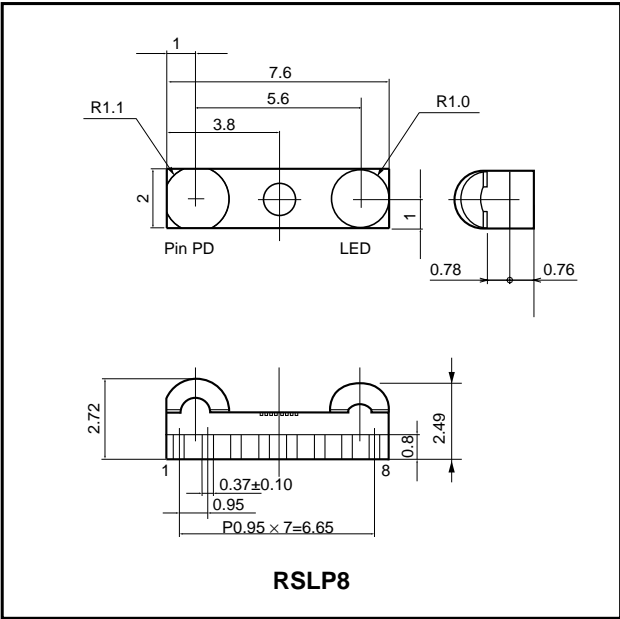

Notes

- No technical content pages of this document may be reproduced in any form or transmitted by any means without prior permission of ROHM CO.,LTD.
- The contents described herein are subject to change without notice. The specifications for the product described in this document are for reference only. Upon actual use, therefore, please request that specifications to be separately delivered.
- Application circuit diagrams and circuit constants contained herein are shown as examples of standard use and operation. Please pay careful attention to the peripheral conditions when designing circuits and deciding upon circuit constants in the set.
- Any data, including, but not limited to application circuit diagrams information, described herein are intended only as illustrations of such devices and not as the specifications for such devices. ROHM CO.,LTD. disclaims any warranty that any use of such devices shall be free from infringement of any third party's intellectual property rights or other proprietary rights, and further, assumes no liability of whatsoever nature in the event of any such infringement, or arising from or connected with or related to the use of such devices.
- Upon the sale of any such devices, other than for buyer's right to use such devices itself, resell or otherwise dispose of the same, no express or implied right or license to practice or commercially exploit any intellectual property rights or other proprietary rights owned or controlled by
- ROHM CO., LTD. is granted to any such buyer.
- Products listed in this document are no antiradiation design.

The products listed in this document are designed to be used with ordinary electronic equipment or devices (such as audio visual equipment, office-automation equipment, communications devices, electrical appliances and electronic toys).

Should you intend to use these products with equipment or devices which require an extremely high level of reliability and the malfunction of which would directly endanger human life (such as medical instruments, transportation equipment, aerospace machinery, nuclear-reactor controllers, fuel controllers and other safety devices), please be sure to consult with our sales representative in advance.

About Export Control Order in Japan

Products described herein are the objects of controlled goods in Annex 1 (Item 16) of Export Trade Control Order in Japan.

In case of export from Japan, please confirm if it applies to "objective" criteria or an "informed" (by MITI clause) on the basis of "catch all controls for Non-Proliferation of Weapons of Mass Destruction.