

# GP1A13R OPIC Photointerrupter with Encoder Function

## Features

1. A, B 2-phase digital output
2. Resolution : Slit pitch 1.6mm
3. TTL compatible output
4. Compact and light

## Applications

1. Electronic printers
2. Robots
3. Numerical control machines

## Outline Dimensions (Unit : mm)

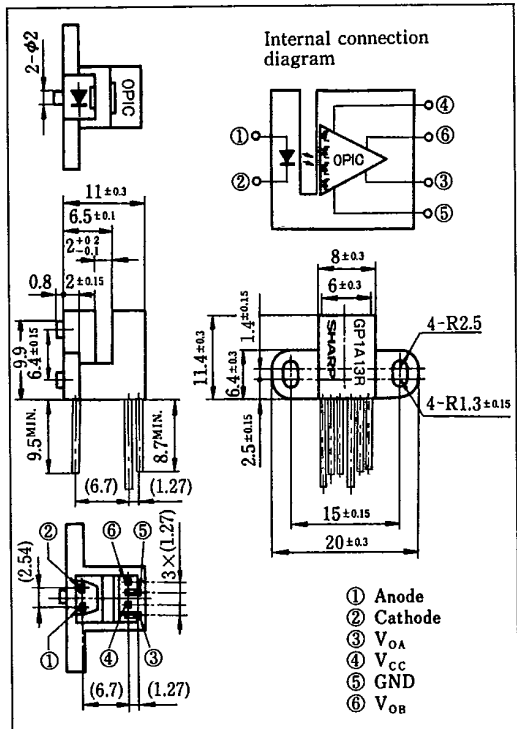

\* OPIC is a registered trademark of Sharp and stands for Optical IC. It has a light detecting element and signal processing circuitry integrated onto a single chip.

## Absolute Maximum Ratings (Ta = 25°C)

Parameter	Symbol	Rating	Unit
Input	Forward current	I <sub>F</sub>	50 mA
	*1 Peak forward current	I <sub>FM</sub>	1 A
	Reverse voltage	V <sub>R</sub>	6 V
	Power dissipation	P	75 mW
Output	Supply voltage	V <sub>CC</sub>	7 V
	Low level output current	I <sub>OL</sub>	20 mA
	Power dissipation	P <sub>O</sub>	250 mW
	Operating temperature	T <sub>opr</sub>	0 ~ +70 °C
	Storage temperature	T <sub>stg</sub>	-40 ~ +80 °C
*2 Soldering temperature	T <sub>sol</sub>	260 °C	

\*1 Pulse width ≤ 100 μs, Duty ratio = 0.01  
 \*2 For 5 seconds

■ Electro-optical Characteristics

(Ta=0~+70°C unless specified)

Parameter		Symbol	Conditions	MIN.	TYP.	MAX.	Unit
Input	Forward voltage	$V_F$	Ta=25°C, $I_F=20\text{mA}$	—	1.2	1.4	V
	Reverse current	$I_R$	Ta=25°C, $V_R=3\text{V}$	—	—	10	$\mu\text{A}$
Output	Operating supply voltage	$V_{CC}$		4.5	5.0	5.5	V
	High level output voltage	$V_{OL}$	$V_{CC}=5\text{V}$ , $I_F=20\text{mA}$ , $I_{OL}=8\text{mA}^{**}$	—	0.1	0.4	V
	Low level output voltage	$V_{OH}$	$V_{CC}=5\text{V}$ , $I_F=20\text{mA}^{**}$	2.4	4.9	—	V
	Supply current	$I_{CC}$	$I_F=20\text{mA}$ , $V_{CC}=5\text{V}^{*3,*4}$	—	5	20	mA
Transfer characteristics	Duty ratio	$^{*5}D_A$	$V_{CC}=5\text{V}$ , $I_F=20\text{mA}$	0.25	0.50	0.75	—
		$^{*5}D_B$	$f=2.5\text{kHz}^{**}$	0.25	0.50	0.75	—
	Response frequency	$f_{max}$	$V_{CC}=5\text{V}$ , $I_F=20\text{mA}^{**}$	—	—	10	kHz

- \*3 In the condition that output A and B are low level.
- \*4 Measured under the condition shown in Measurement Condition.
- \*5  $D_A : \frac{t_{AH}}{t_{AP}}$ ,  $D_B : \frac{t_{BH}}{t_{BP}}$

■ Output Waveforms

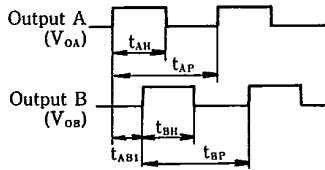

Rotational direction : Counterclockwise when seen from OPIC light detector



Fig. 1 Forward Current vs. Ambient Temperature

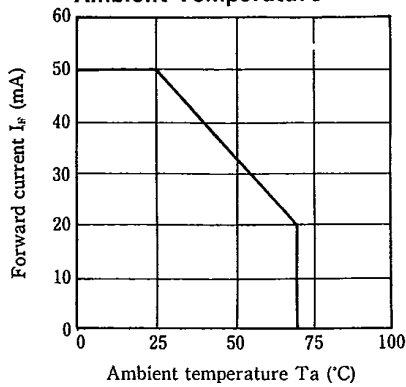

Fig. 2 Output Power Dissipation vs. Ambient Temperature

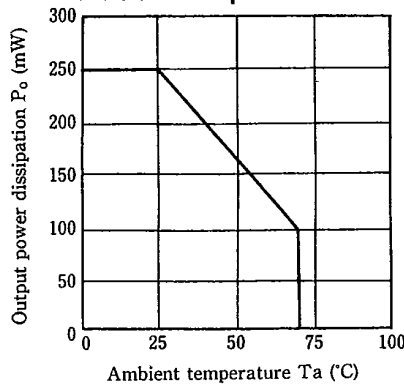

Fig. 3 Duty Ratio vs. Frequency

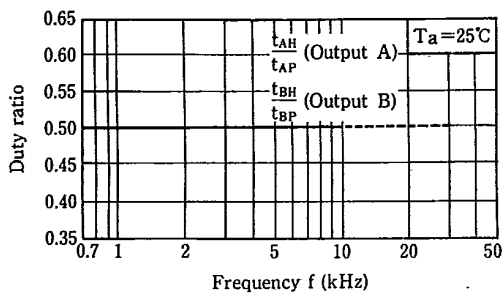

Fig. 4 Phase Difference vs. Frequency

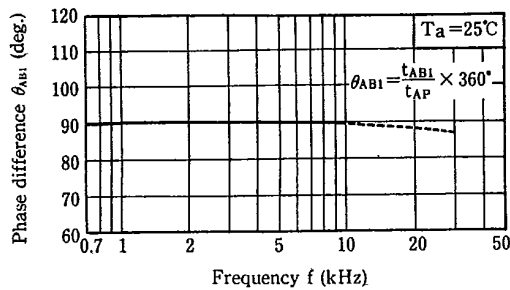

Fig. 5 Duty Ratio vs. Ambient Temperature

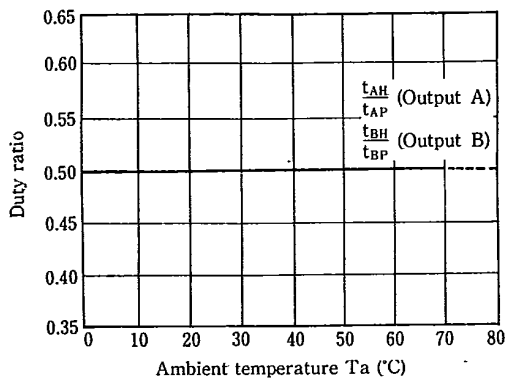

Fig. 6 Phase Difference vs. Ambient Temperature

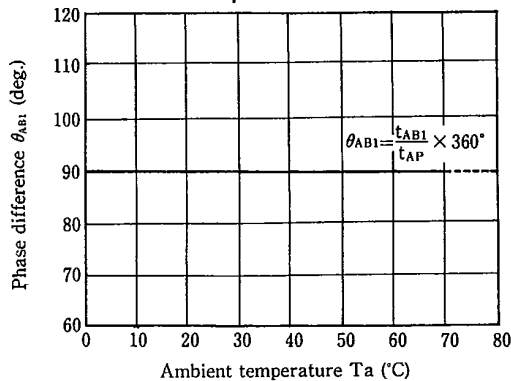

Fig. 7 Duty Ratio vs. Distance (X direction)

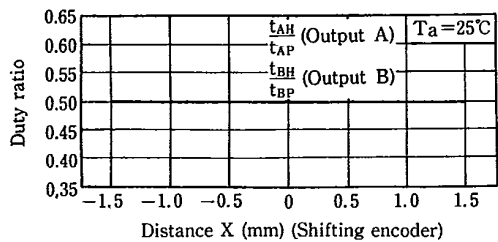

Fig. 8 Phase Difference vs. Distance (X direction)

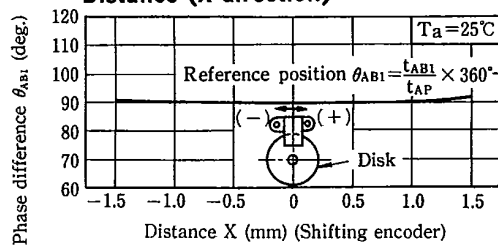

Fig. 9 Duty Ratio vs. Distance (Y direction)

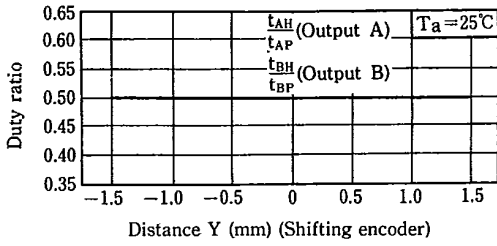

Fig.10 Phase Difference vs. Distance (Y direction)

T-41-73

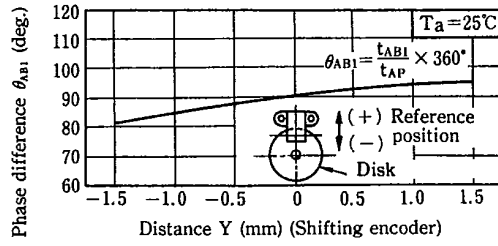

Fig. 11 Duty Ratio vs. Distance (Z direction)

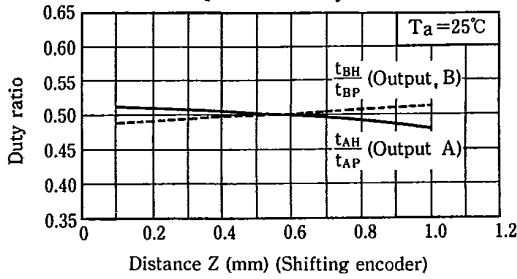
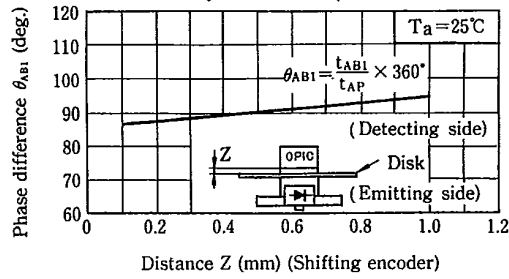
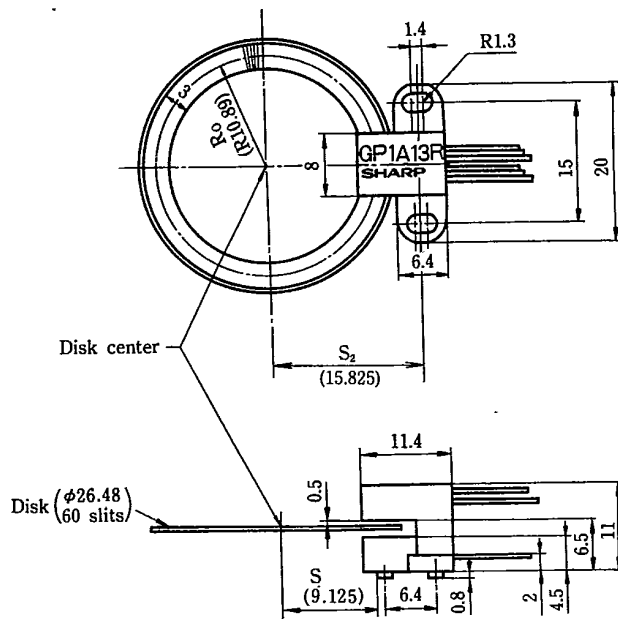

Fig. 12 Phase Difference vs. Distance (Z direction)



7

## 〈Measuring Condition〉

**Basic Design**

$R_0$  (distance between the disk center and half point of a slit) and  $S$  (fixing position of photointerrupter) will be provided by the following equations.

$$R_0 = \frac{N}{60} \times 10.89 \text{ (mm)} \quad N : \text{number of slits}$$

$$S_1 = R_0 - 1.765 \text{ (mm)} \quad S_2 = S_1 + 6.7 \text{ (mm)}$$

Note) When the number of slits is changed, values in parenthesis are also changed according to the number.

**(Precautions for Use)**

- 1) In order to stabilize power supply line, connect a by-pass capacitor of more than  $0.01\mu\text{F}$  between  $V_{CC}$  and GND near the device.
- 2) This module is designed to be operated at  $I_F = 20\text{mA}$  TYP.