

Photodetektor mit Spannungsausgang Light to Voltage Converter

SFH 5130



Wesentliche Merkmale

- Integrierter Fotodetektor mit linearem Spannungsausgang
- Transparentes Plastikgehäuse mit 3 Pins
- Hohe Empfindlichkeit von 350 nm bis 1100 nm
- Runde Fotodiode

Anwendungen

- Lichtschranken

Features

- Integrated photodiode with linear voltage output
- Transparent sidelooker package with 3 pins
- High sensitivity from 350 nm to 1100 nm
- Circular photodiode

Applications

- Photointerrupter

Typ Type	Bestellnummer Ordering Code	Gehäuse Package
SFH 5130	on request	Sidelooker Gehäuse Sidelooker Package

Grenzwerte
Maximum Ratings

Bezeichnung Parameter	Symbol Symbol	Wert Value	Einheit Unit
Lagertemperatur Storage temperature range	T_{stg}	- 40 ... + 85	°C
Versorgungsspannung Supply Voltage	V_{DD}	6	V
Ausgangsspannung Output voltage	V_{OUT}	< V_{DD}	V
Elektrostatische Entladung Electrostatic Discharge Human Body Model according to EOS/ESD-5.1-1993	<i>ESD</i>	2	kV

Empfohlener Arbeitsbereich
Recommended Operating Conditions

Bezeichnung Parameter	Symbol Symbol	Wert Value			Einheit Unit
		min.	typ.	max.	
Funktionstemperatur Operating Temperature	T_{op}	- 40	+ 25	+ 75	°C
Betriebsspannung Supply Voltage	V_{DD}	4.5	5	5.5	V
Kapazitive Ausgangslast Output load capacitance	C_{L}			30	nF

Kennwerte ($T_{\text{A}} = 25 \text{ °C}$, $V_{\text{DD}} = 5 \text{ V}$, $R_{\text{L}} = 10 \text{ k}\Omega$)

Characteristics

Bezeichnung Parameter	Symbol Symbol	Wert Value			Einheit Unit
		min.	typ.	max.	
Stromaufnahme, $E_{\text{e}} = 0$ Current consumption	I_{DD}	–	1.5	4.5	mA
Dunkelspannung Dark Voltage	V_{D}	–	1.2	15	mV
Spektraler Bereich der Fotoempfindlichkeit Spectral range of sensitivity	λ	350	–	1100	nm

Kennwerte ($T_A = 25\text{ °C}$, $V_{DD} = 5\text{ V}$, $R_L = 10\text{ k}\Omega$)

Characteristics

Bezeichnung Parameter	Symbol Symbol	Wert Value			Einheit Unit
		min.	typ.	max.	
Wellenlänge der max. Fotoempfindlichkeit Wavelength of max. photosensitivity	$\lambda_{s\text{ max}}$	–	770	–	nm
Durchmesser der aktiven Fläche Diameter of active area	D	–	0.75	–	mm
Empfindlichkeit ¹⁾ , $\lambda = 428\text{ nm}$ Irradiance responsivity	N_e	–	1180	–	mV/ $\mu\text{W}/\text{cm}^2$
Ausgangsspannung ¹⁾ Output Voltage, $E_e = 1.69\text{ }\mu\text{W}/\text{cm}^2$, $\lambda = 428\text{ nm}$	V_O	1.0	–	3.2	V
Sättigungsspannung, $V_{DD} = 4.5\text{ V}$, $E_e \geq 7\text{ }\mu\text{W}/\text{cm}^2$ Maximum output voltage swing	V_{sat}	4	4.47	–	V
Anstiegszeit ²⁾ , $E_e = 0$ to $E_e = 1.69\text{ }\mu\text{W}/\text{cm}^2$ Rise time	t_r	–	50	250	μs
Abfallzeit, $E_e = 1.69$ to $0\text{ }\mu\text{W}/\text{cm}^2$ Fall time	t_f	–	70	250	μs
Einschwingzeit, to 99% of nominal Settling time	t_s	–	90	–	μs
Temperaturkoeffizient der Dunkelspannung, $T = 5$ to 45 °C Temperature coefficient of dark voltage	α_{vd}	– 100	± 8	+ 100	$\mu\text{V}/\text{K}$
Temperaturkoeffizient der Ausgangsspannung Temperature coefficient of output voltage $E_e = 1.69\text{ }\mu\text{W}/\text{cm}^2$, $\lambda = 428\text{ nm}$, $T = 5$ to 45 °C	α_{vo}	– 3	± 1	+ 3	mV/K
Power supply rejection ratio ³⁾ $f_{\text{ac}} = 100\text{ Hz}$ $f_{\text{ac}} = 1\text{ kHz}$	PSRR PSRR	–	45	–	dB dB
Output noise voltage $f = 0$ to 1 kHz $f = 10\text{ Hz}$ $f = 100\text{ Hz}$ $f = 1\text{ kHz}$		–	< 1	–	$\mu\text{V RMS}$ $\mu\text{V}/\text{Hz}^{(1/2)}$ $\mu\text{V}/\text{Hz}^{(1/2)}$ $\mu\text{V}/\text{Hz}^{(1/2)}$

¹⁾ The sensitivity is characterized using 428 nm LEDs as light source. A constant irradiance over the whole lens area is created.

- 2) The light source used is a 428 nm LED with following characteristics: $t_r > 1 \mu\text{s}$, $t_f < 1 \mu\text{s}$. The output waveform is monitored on an oscilloscope with $t_r > 100 \text{ ns}$, $Z_i = 1 \text{ M}\Omega$, $C_i < 20 \text{ pF}$. The rise time is defined as the time from the 10% to the 90% value, the fall time is defined as the time from the 90% to the 10% value.
- 3) PSRR is defined as $20 \log (V_{\text{DD}}(f) / V_{\text{O}}(f))$ with $V_{\text{DD}}(0 \text{ Hz}) = 4.5 \text{ V}$ and $V_{\text{O}}(0 \text{ Hz}) = 2 \text{ V}$

Lötbedingungen Soldering Conditions

Type	Dip, wave and drag soldering		
	Temperature of soldering bath	Max permissible soldering time	Distance between solder joint and package
SFH5130	260 s	10 s	1.5 mm

Spectral Sensitivity

$S_{rel} = f(\lambda)$

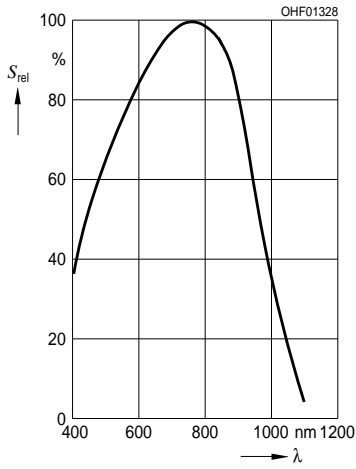

Current Consumption

$I_{DD} = f(V_{DD})$

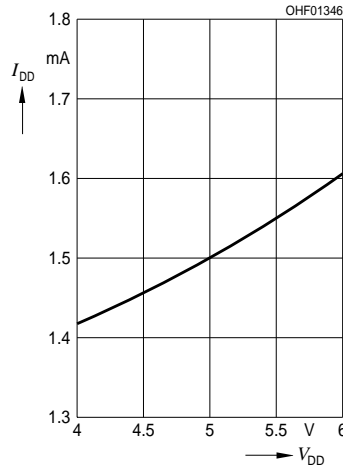

Dark Voltage

$V_D = f(V_{DD})$

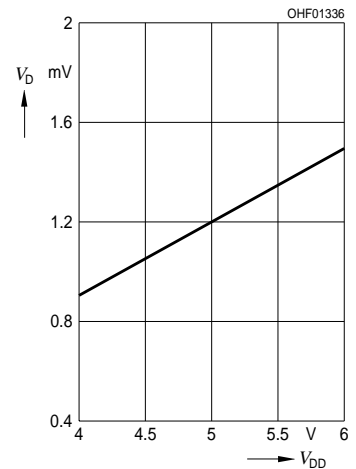

**Output Voltage, $V_O = f(T_A)$,
 $E_e = 1.69 \mu\text{W}/\text{cm}^2, \lambda = 428\text{nm}$**

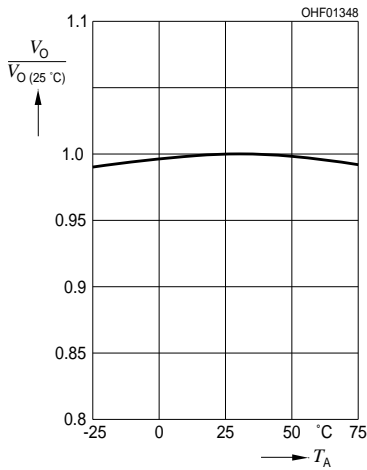

Current Consumption

$I_{DD} = f(T_A)$

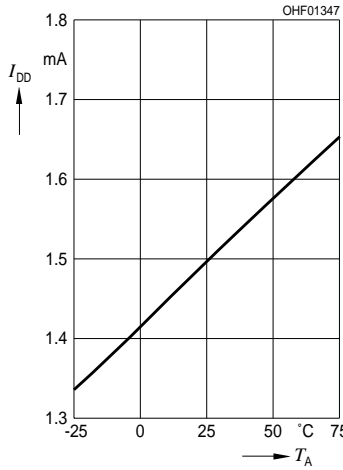

Dark Voltage

$V_D = f(T_A)$

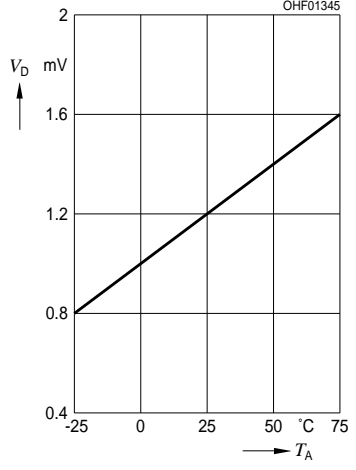

Linearity

$V_O = f(E_e)$

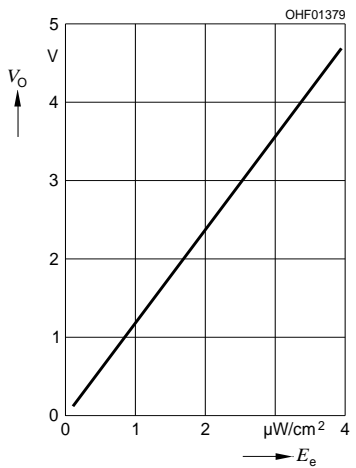

Directional Characteristics

$V_O = f(\phi)$

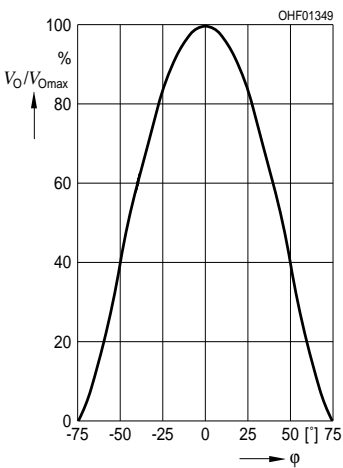

Maßzeichnung Package Outlines

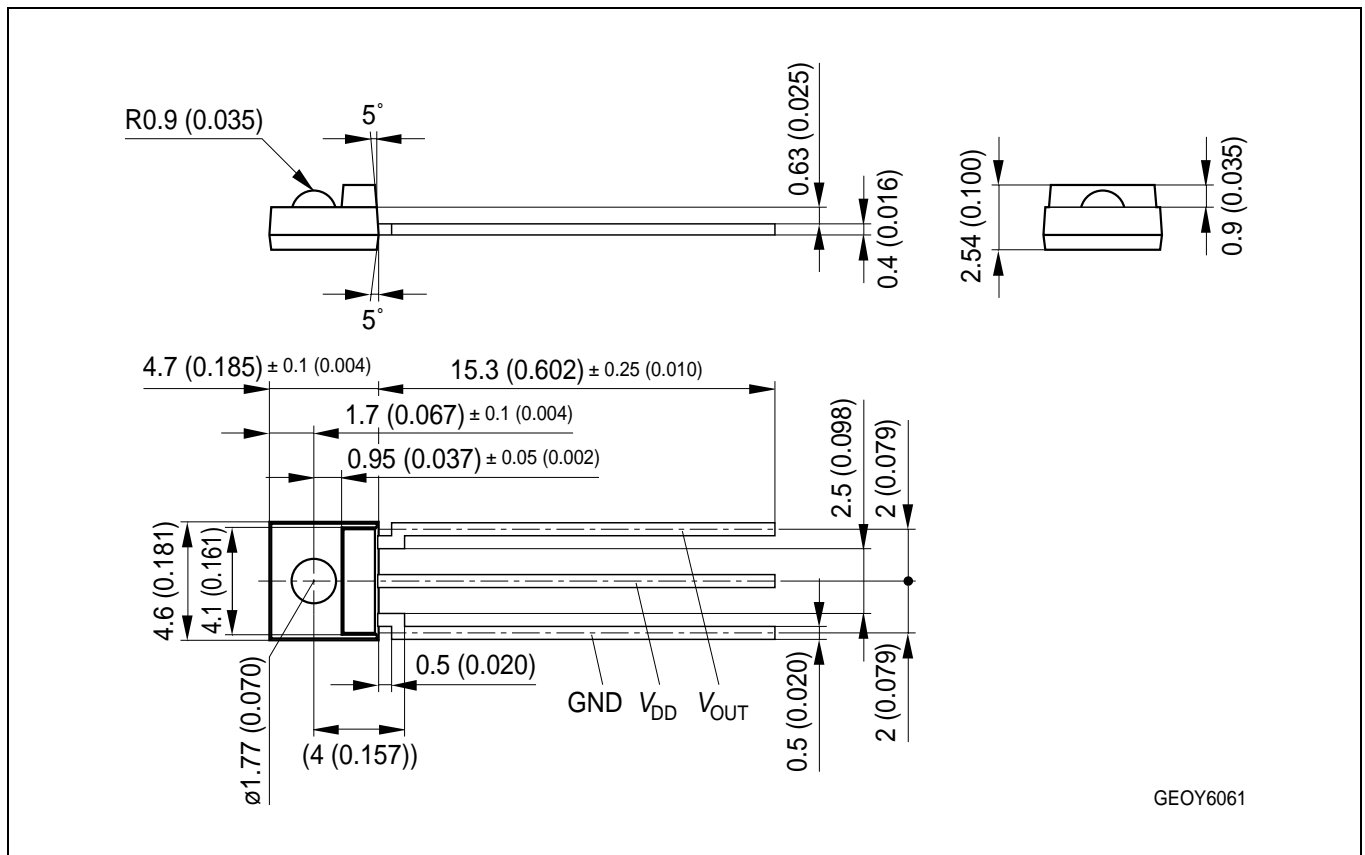

Maße werden wie folgt angegeben: mm (inch) / Dimensions are specified as follows: mm (inch).

Published by OSRAM Opto Semiconductors GmbH & Co. OHG
Wernerwerkstrasse 2, D-93049 Regensburg

© All Rights Reserved.

Attention please!

The information describes the type of component and shall not be considered as assured characteristics. Terms of delivery and rights to change design reserved. Due to technical requirements components may contain dangerous substances. For information on the types in question please contact our Sales Organization.

Packing

Please use the recycling operators known to you. We can also help you – get in touch with your nearest sales office. By agreement we will take packing material back, if it is sorted. You must bear the costs of transport. For packing material that is returned to us unsorted or which we are not obliged to accept, we shall have to invoice you for any costs incurred.

Components used in life-support devices or systems must be expressly authorized for such purpose! Critical components ¹, may only be used in life-support devices or systems ² with the express written approval of OSRAM OS.

¹ A critical component is a component used in a life-support device or system whose failure can reasonably be expected to cause the failure of that life-support device or system, or to affect its safety or effectiveness of that device or system.

² Life support devices or systems are intended (a) to be implanted in the human body, or (b) to support and/or maintain and sustain human life. If they fail, it is reasonable to assume that the health of the user may be endangered.