

# Remote control photosensitive IC

## RPM6900 Series

The RPM6900 series are remote control photosensitive units in a compact, lightweight package made from a resin mold.

### ●Applications

VCRs, TVs, movies, air conditioners, audio equipment, and other household electrical appliances

### ●Features

- 1) Resin mold package enables a compact size and light weight.
- 2) Built-in electromagnetic shield.

### ●RPM6900 series models

Model	Carrier frequency
RPM6933	33.0kHz
RPM6933-V4	33.0kHz
RPM6936	36.0kHz
RPM6936-V4	36.0kHz
RPM6937	36.7kHz
RPM6937-V4	36.7kHz
RPM6938	37.9kHz
RPM6938-V4	37.9kHz
RPM6940	40.0kHz
RPM6940-V4	40.0kHz
RPM6957	56.9kHz
RPM6957-V4	56.9kHz

\*The V4 models are forming types.

### ●Absolute maximum ratings (Ta = 25°C)

Parameter	Symbol	Limits	Unit	Conditions
Supply voltage	V <sub>CC</sub>	6.3	V	
Output sink current	I <sub>o</sub>	2.5	mA	
Storage temperature	T <sub>stg</sub>	-30~+100	°C	
Soldering temperature	T <sub>sol</sub>	260	°C	3mm from the lead bottom, within 5sec

### ●Recommended operating conditions

Parameter	Symbol	Min.	Typ.	Max.	Unit
Supply voltage	V <sub>CC</sub>	4.5	5.0	5.5	V
Operating temperature	T <sub>opr</sub>	-10	25	75	°C

Note: Specifications may change without notice due to improvements in the product.

●Block diagram

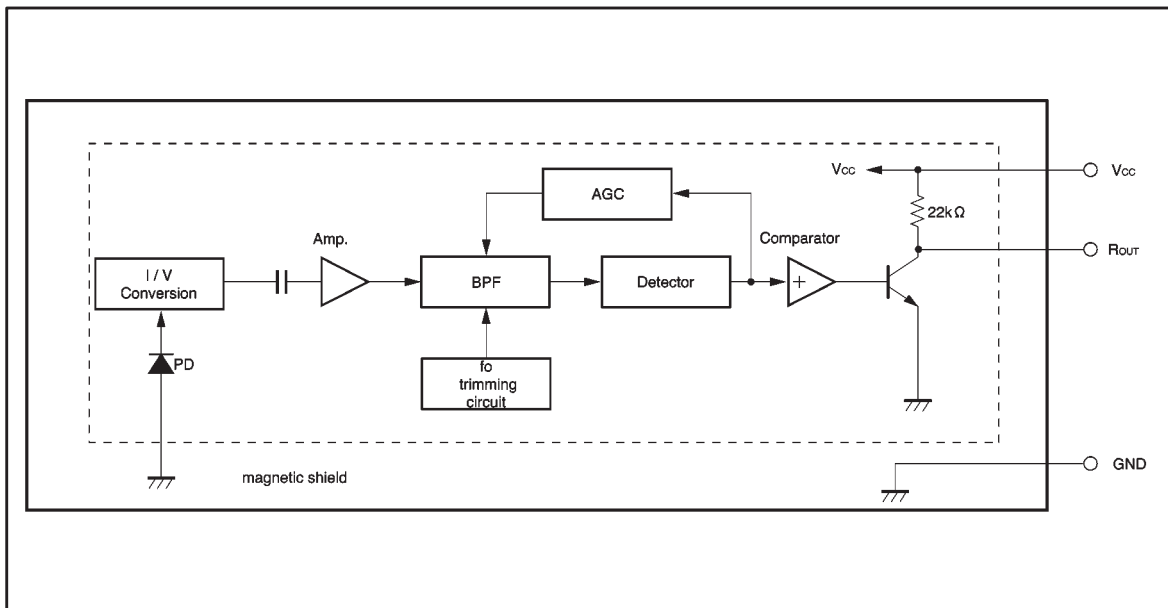

●Electrical, optical characteristics ( $V_{CC} = 5V$ ,  $T_a = 25^{\circ}C$ )

Parameter	Symbol	Min.	Typ.	Max.	Unit	Conditions
Consumption current	$I_{CC}$	—	1.5	2.0	mA	No outside light, no signal input
Arrival distance	L	8	12	—	m	*1 Outer light condition $E_e < 10(I_x)$
High level output voltage	$V_H$	4.5	—	—	V	*1
Low level output voltage	$V_L$	—	—	0.5	V	*1 $I_o = 400 \mu A$
ON pulse width	$T_{ON}$	400	600	800	$\mu s$	*1 Outer light condition $E_e < 10(I_x)$
OFF pulse width	$T_{OFF}$	400	600	800	$\mu s$	*1 Outer light condition $E_e < 10(I_x)$
Center frequency	$f_o$	—	37.9	—	KHz	
Horizontal direction characteristics	$\theta_{80\%}$	—	35	—	deg	*2
Vertical direction characteristics	$\theta_{80\%}$	—	30	—	deg	*2

\*1 The burst wave form mentioned in fig.1 is to be transmitted from standard transmitter (fig.2).  
Measure 10th or later pulse width after beginning of transmission.

\*2 The angle which arrival distance become 80% of L. (arrival distance at  $\theta = 0^{\circ}$ ).

ON / OFF pulse width is to be satisfied within 0.5cm ~ arrival distance.

● Measurement conditions

(1) Transmit signal

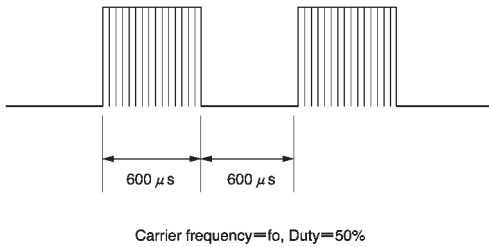

Fig.1 Transmit signal

(2) Standard transmitter

$\lambda$  peak = 940nm  
 $\Delta \lambda$  = 40nm

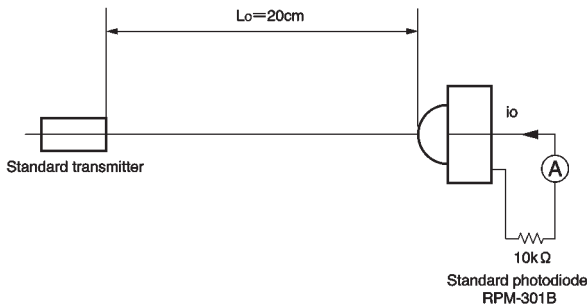

Fig.2 Measurement of standard transmitter proofreading

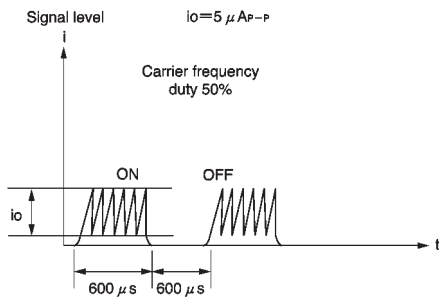

Fig.3 Standard photodiode current

(3) Measurement arrival distance, Horizontal & vertical half angle

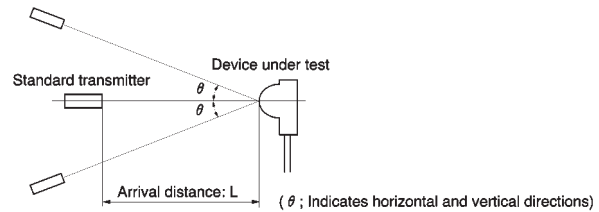

Fig.4 Measurement condition for arrival distance

Arrival distance L:

Arrival distance at  $\theta = 0^\circ$  Fig.4

Horizontal & vertical half angle  $\theta$ :

The angle which arrival distance became 50% of L.

(4) High level, low level output voltage

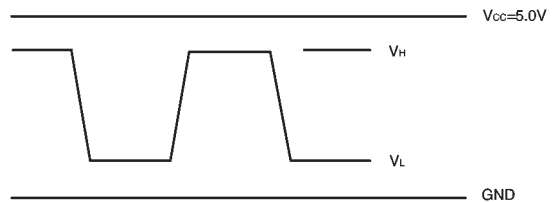

When standard transmitter output the signal at Fig.1 standard photodiode output become  $i_o = 5 \mu\text{A P-P}$  under the measurement condition Fig.2, Fig.3.

RPM-301B: standard photodiode has short current  $I_{SC} = 27 \mu\text{A}$  at  $E = 10001x$  (using CIE standard light source A)

## ● Measurement circuit

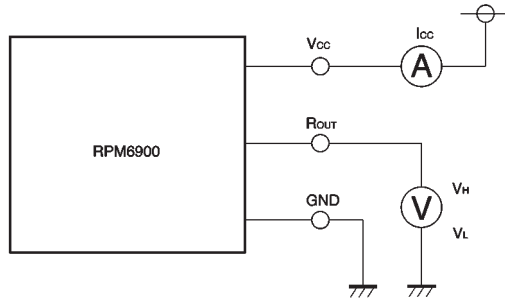

Fig.5

## ● Recommended application

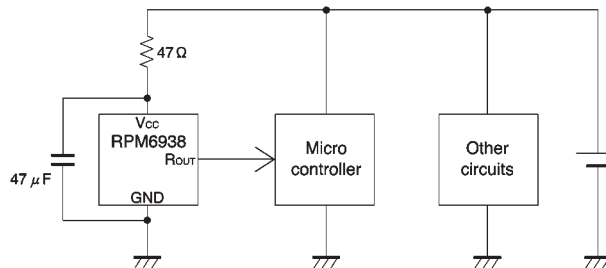

Fig.6

- Please place filter (resistors and capacitors) as close to the receiver as possible.
- In order to stable operation, using serial resistor ( $47\Omega$ ) on power supply line and capacitor (more than  $47\mu\text{F}$ ) between power supply and GND is recommended.

(This reduce influence by switching power supply ripple and ripple which caused by the change of micro controller load and other circuits load.)

Without the above circuit, Arrival distance might be less due to noise pulse on output wave.

(In case even with the above mentioned value, please change bigger capacitance.)

## ● Operation notes

(1) All characteristics of the receiver in this specification are specified by supplying burst wave form with ROHM standard transmitter (Fig.2).

If in case of other burst wave form will be used, please check these spec. Carefully under the evaluations.

(2) When the receiver will be used as the wire-less remote controller, please use the signal method the signal format which refer to "Measures to prevent miss-functioning of IR remote-controlled electric home appliances".

(Published July 1987 by Association of Electric Home

Appliances)

However, please use the standard pulse width (T) of greater than 0.4ms and less than 0.6ms ( $0.4\text{ms} < T < 0.6\text{ms}$ )

If using other signal method, signal format, (ex: signal format which not including the leader signal) the receiver might have chances to miss-function.

(3) Please set up transmitter's carrier frequency as same as the receiver's  $f_0$  frequency. Otherwise error might be occurred.

(4) If transmission signal has non-continues carrier, error might be occurred. Continuous carrier is necessary.

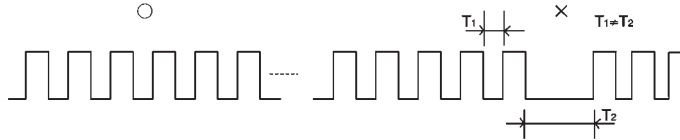

(5) The receiver was designed to use as in-door use only. Therefore, please understand that the receiver cannot cover all characteristics, in case of using it out-door.

(6) Emitting unit (remove control transmitter) has to be considered about its emitting device function, characteristics and characteristics of the receiver.

(7) Do not supply unnecessary stress to lead and holder.

(8) Please pay careful attention to the lens.

It might has a chance to miss-function when the lens get dust or dirty. And also please do not touch the lens.

(9) In order to prevent IC from ESD, human body, solder iron, etc are required to be grounded.

●Electrical, optical characteristics curves

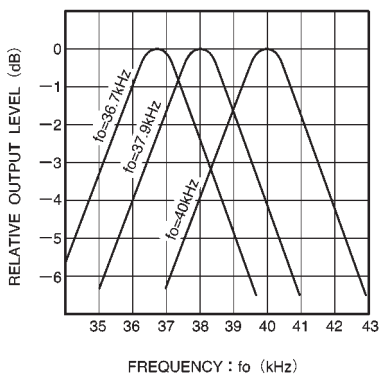

Fig.7 B.P.F. characteristics

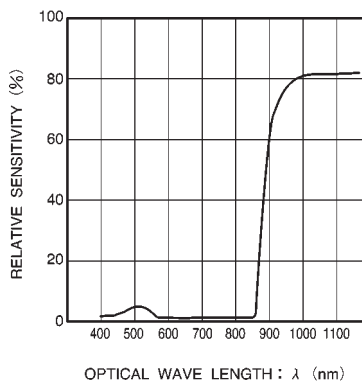

Fig.8 Package transmittance (measured on flat board at  $t=3.5$  mm)

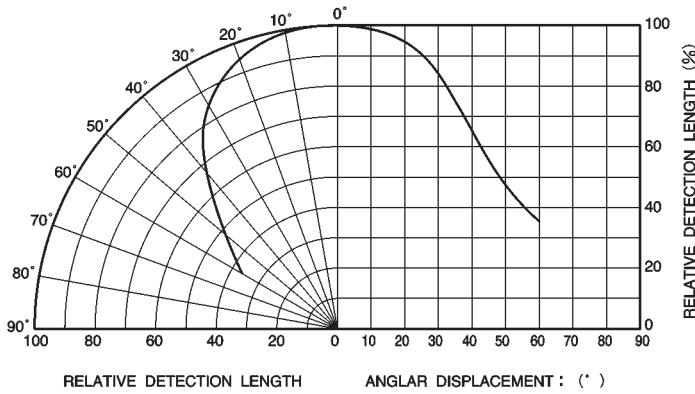

Fig.9 Directional characteristics in vertical direction

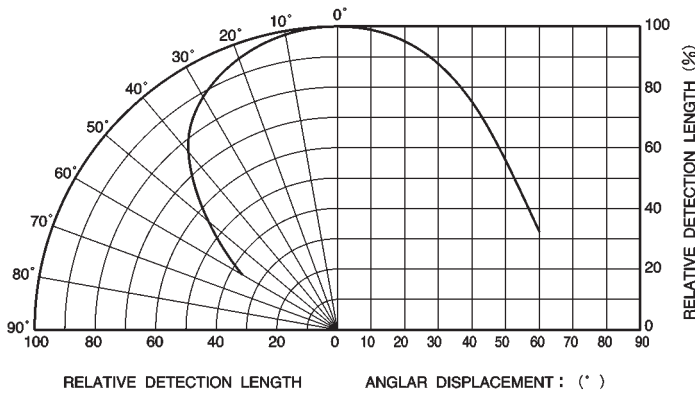

Fig.10 Directional characteristics in horizontal direction

● External dimensions (Units: mm)

