

AlGaInP Visible Laser Diode

ADX-6305STL

DATE : 2005/11/01 Ver 1.0

★635nm 5mW 40°C cost effective type

• Features

1. Cost effective
2. High precision assembly
3. High visibility

• Applications

1. General purpose red laser light source
2. Industrial laser markers / measuring instruments
3. Laser pointers / levelers

• Absolute maximum ratings

Parameter	Symbol	Condition	Rating	Unit
Light output power	P_O	CW	7	mW
Reverse voltage (LD)	V_{RL}	-	2	V
Reverse voltage (PD)	V_{RD}	-	30	V
Forward current (PD)	I_{FD}	-	10	mA
Case temperature	T_C	-	-10~+40	°C
Storage temperature	T_S	-	-40~+85	°C

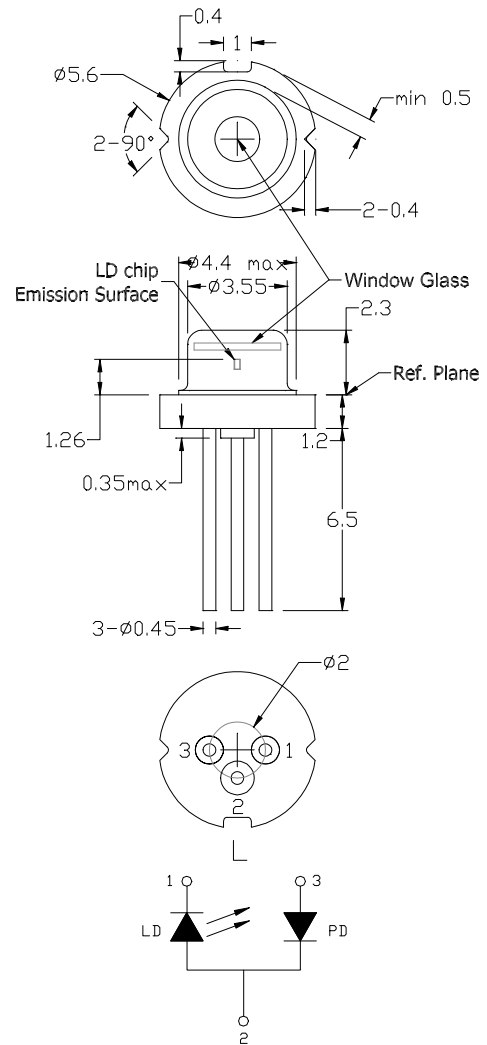

• Electrical and optical characteristics ($T_c=25^\circ\text{C}$)

Parameter	Symbol	Min.	Typ.	Max.	Unit	Conditions
Peak wavelength	λ	630	635	640	nm	$P_o=5\text{mW}$
Threshold current	I_{th}	-	25	30	mA	
Operating current	I_{op}	-	33	40	mA	$P_o=5\text{mW}$
Operating voltage	V_{op}	-	2.2	2.5	V	$P_o=5\text{mW}$
Differential efficiency	η	0.4	0.6	0.8	mW/mA	$P_o=3\sim 5\text{mW}$
Monitor current*	I_m	0.05	0.15	0.3	mA	$P_o=5\text{mW}, V_{RD}=5\text{V}$
Parallel divergence angle	$\theta_{ }$	6	7.5	10	deg	
Perpendicular divergence angle	θ_{\perp}	30	33	36	deg	
Parallel FFP deviation angle	$\Delta\theta_{ }$	-3	0	+3	deg	$P_o=5\text{mW}$
Perpendicular FFP deviation angle	$\Delta\theta_{\perp}$	-3	0	+3	deg	
Emission point accuracy	$\Delta x \Delta y \Delta z$	-80	0	+80	um	

*Monitor current ranking is available.

• Precautions

- * Do not operate the device above maximum ratings. Doing so may cause unexpected and permanent damage to the device.
- * Take precautions to avoid electrostatic discharge and/or momentary power spikes. A change in the characteristics of the laser or premature failure may result.
- * Proper heat sinking of the device assures stability and lifetime. Always ensure that maximum operating temperatures are not exceeded.
- * Observing visible or invisible laser beams with the human eye directly, or indirectly, can cause permanent damage. Use a camera to observe the laser.
- * No laser device should be used in any application or situation where life or property is at risk in event of device failure.
- * Specifications are subject to change without notice. Ensure that you have the latest specification by contacting us prior to purchase or use of the product.

* For reference only. Contents above are subject to change without notice.

Arima
LASERS

AlGaInP Visible Laser Diode

ADX-6305STL

DATE : 2005/11/01 Ver 1.0

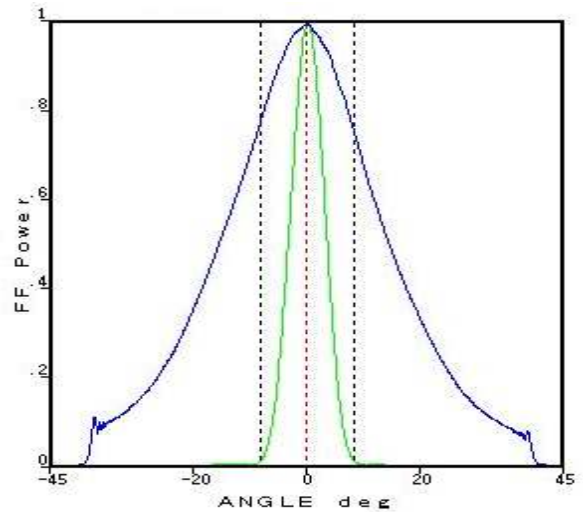
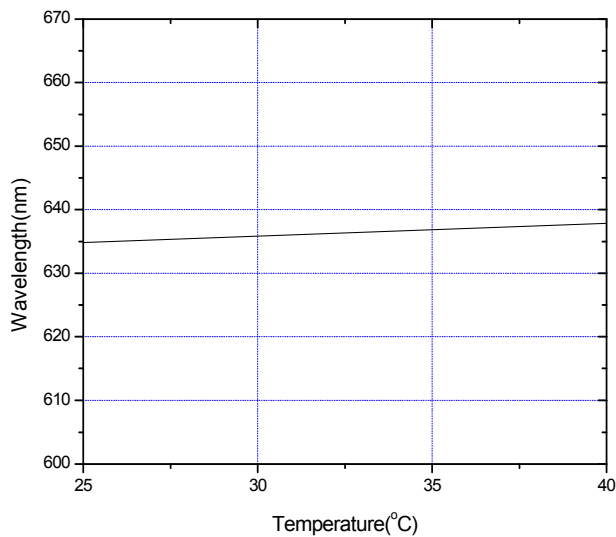
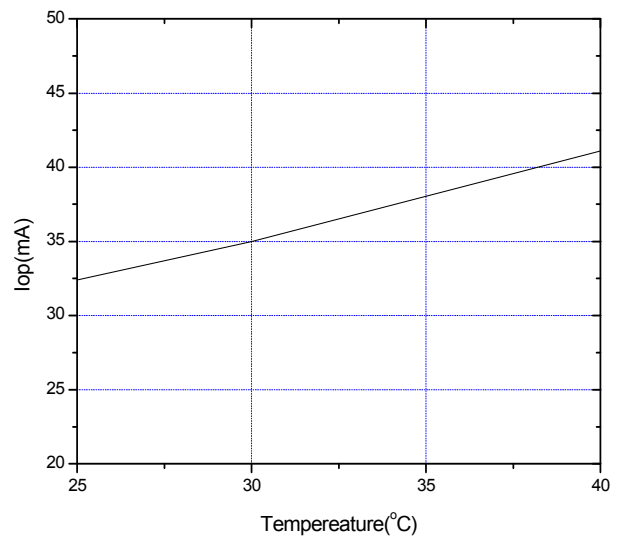
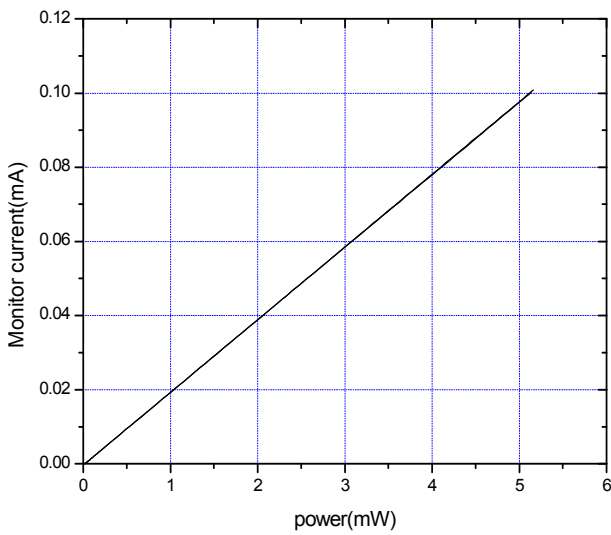
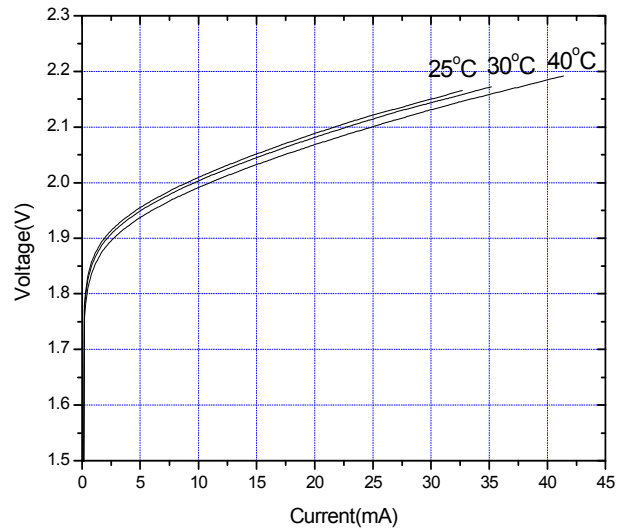
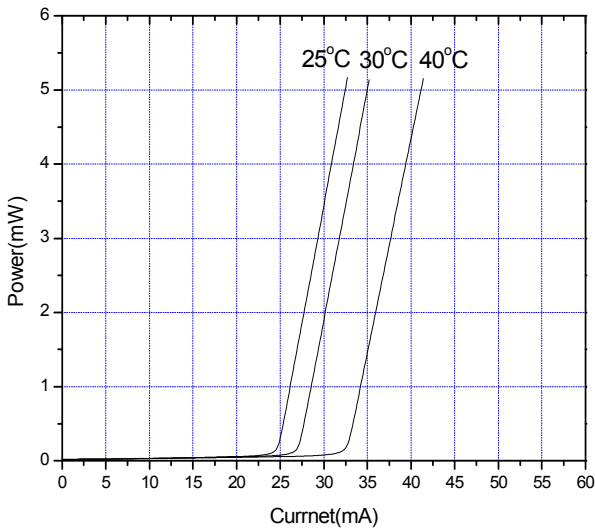

* For reference only. Contents above are subject to change without notice.

Arima
LASERS