

IR Receiver Modules for Remote Control Systems

Description

The TSOP321.. - series are miniaturized receivers for infrared remote control systems. PIN diode and preamplifier are assembled on lead frame, the epoxy package is designed as IR filter.

The demodulated output signal can directly be decoded by a microprocessor. The main benefit is the operation with short burst transmission codes and high data rates at a supply voltage of 3 V.

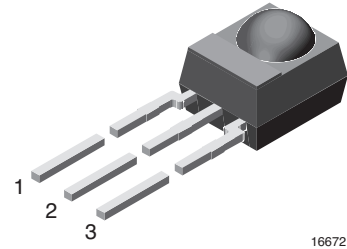

Features

- Photo detector and preamplifier in one package
- Internal filter for PCM frequency
- Improved shielding against electrical field disturbance
- TTL and CMOS compatibility
- Output active low
- Supply voltage range: 2.7 V to 5.5 V
- High immunity against ambient light

Special Features

- Enhanced data rate of 4000 bit/s
- Operation with short bursts possible (≥ 6 cycles/burst)

Mechanical Data

Pinning:

1 = OUT, 2 = V_S , 3 = GND

Parts Table

Part	Carrier Frequency
TSOP32130	30 kHz
TSOP32133	33 kHz
TSOP32136	36 kHz
TSOP32137	36.7 kHz
TSOP32138	38 kHz
TSOP32140	40 kHz
TSOP32156	56 kHz

Block Diagram

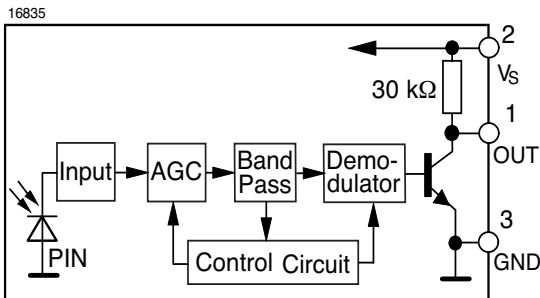

Application Circuit

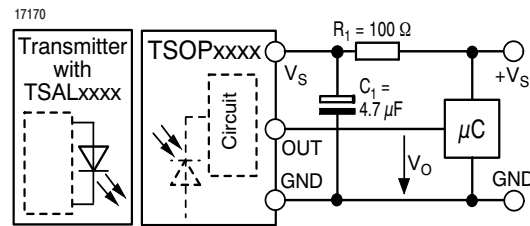

$R_1 + C_1$ recommended to suppress power supply disturbances.

The output voltage should not be held continuously at a voltage below $V_O = 2.0$ V by the external circuit.

Absolute Maximum Ratings

$T_{amb} = 25$ °C, unless otherwise specified

Parameter	Test condition	Symbol	Value	Unit
Supply Voltage	(Pin 2)	V_S	- 0.3 to + 6.0	V
Supply Current	(Pin 2)	I_S	3	mA
Output Voltage	(Pin 1)	V_O	- 0.3 to $(V_S + 0.3)$	V
Output Current	(Pin 1)	I_O	10	mA
Junction Temperature		T_j	100	°C
Storage Temperature Range		T_{stg}	- 25 to + 85	°C
Operating Temperature Range		T_{amb}	- 25 to + 85	°C
Power Consumption	($T_{amb} \leq 85$ °C)	P_{tot}	30	mW
Soldering Temperature	$t \leq 10$ s, 1 mm from case	T_{sd}	260	°C

Electrical and Optical Characteristics

$T_{amb} = 25$ °C, unless otherwise specified

Parameter	Test condition	Symbol	Min	Typ.	Max	Unit
Supply Current (Pin 2)	$E_v = 0$	I_{SD}	0.7	1.2	1.5	mA
	$E_v = 40$ klx, sunlight	I_{SH}		1.3		mA
Supply Voltage		V_S	2.7		5.5	V
Transmission Distance	$E_v = 0$, test signal see fig.1, IR diode TSAL6200, $I_F = 250$ mA	d		35		m
Output Voltage Low (Pin 1)	$I_{OSL} = 0.5$ mA, $E_e = 0.7$ mW/m ² , test signal see fig. 1	V_{OSL}			250	mV
Irradiance (30-40 kHz)	$V_S = 3$ V Pulse width tolerance: $t_{pi} - 5/f_o < t_{po} < t_{pi} + 6/f_o$, test signal see fig.3	$E_{e min}$		0.2	0.4	mW/m ²

Parameter	Test condition	Symbol	Min	Typ.	Max	Unit
Irradiance (56 kHz)	$V_S = 3\text{ V}$ Pulse width tolerance: $t_{pi} - 5/f_0 < t_{po} < t_{pi} + 6/f_0$, test signal see fig.3	$E_e \text{ min}$		0.3	0.5	mW/m^2
Irradiance (30-40 kHz)	$V_S = 5\text{ V}$ Pulse width tolerance: $t_{pi} - 5/f_0 < t_{po} < t_{pi} + 6/f_0$, test signal see fig.3	$E_e \text{ min}$		0.35	0.5	mW/m^2
Irradiance (56 kHz)	$V_S = 5\text{ V}$ Pulse width tolerance: $t_{pi} - 5/f_0 < t_{po} < t_{pi} + 6/f_0$, test signal see fig.3	$E_e \text{ min}$		0.45	0.6	mW/m^2
Irradiance	$t_{pi} - 5/f_0 < t_{po} < t_{pi} + 6/f_0$, test signal see fig. 3	$E_e \text{ max}$	30			W/m^2
Directivity	Angle of half transmission distance	$\varphi_{1/2}$		± 45		deg

Typical Characteristics ($T_{\text{amb}} = 25\text{ }^\circ\text{C}$ unless otherwise specified)

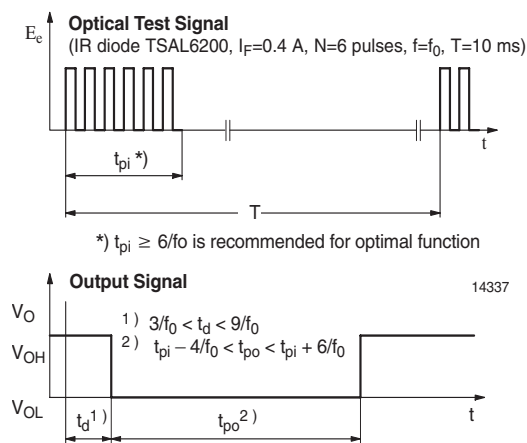

Figure 1. Output Function

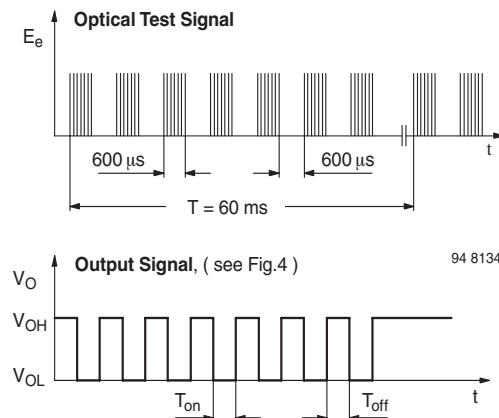

Figure 3. Output Function

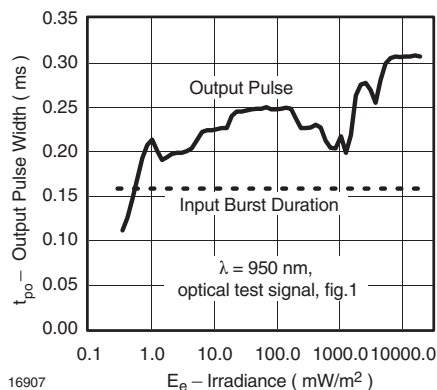

Figure 2. Pulse Length and Sensitivity in Dark Ambient

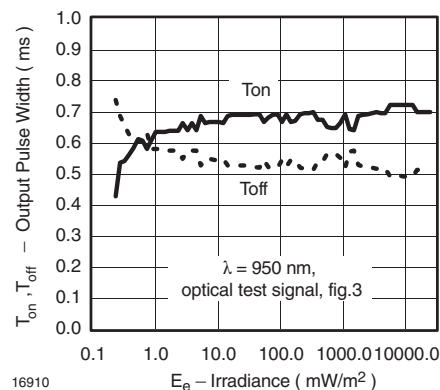

Figure 4. Output Pulse Diagram

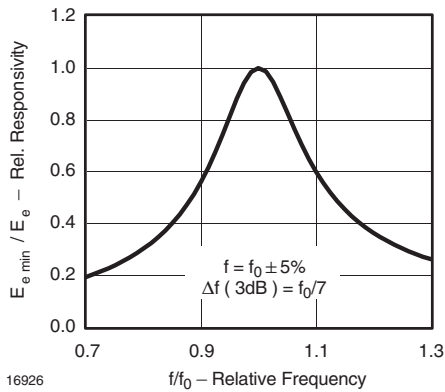

Figure 5. Frequency Dependence of Responsivity

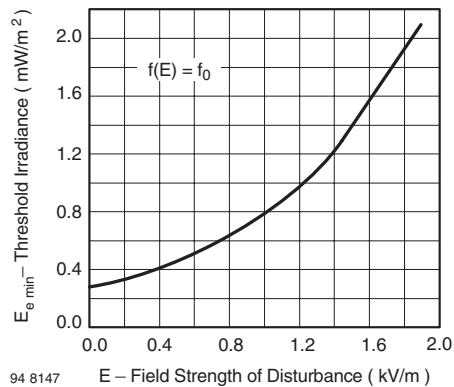

Figure 8. Sensitivity vs. Electric Field Disturbances

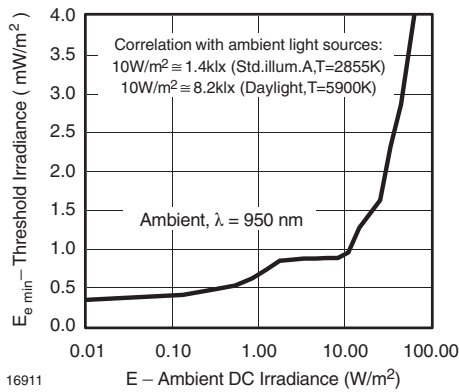

Figure 6. Sensitivity in Bright Ambient

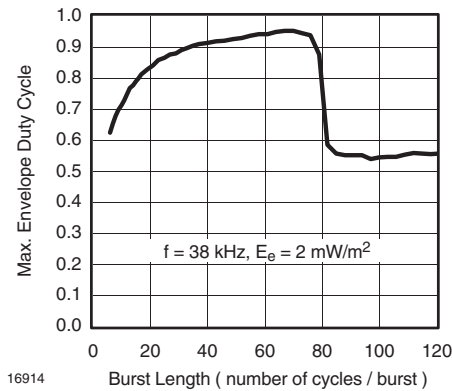

Figure 9. Max. Envelope Duty Cycle vs. Burstlength

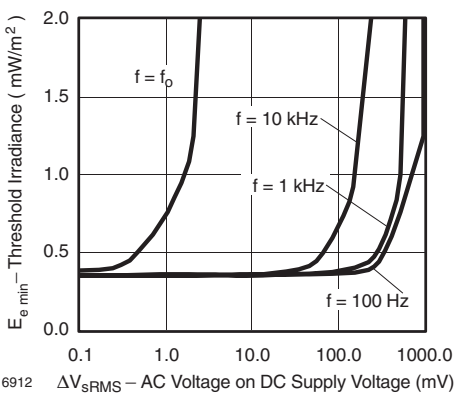

Figure 7. Sensitivity vs. Supply Voltage Disturbances

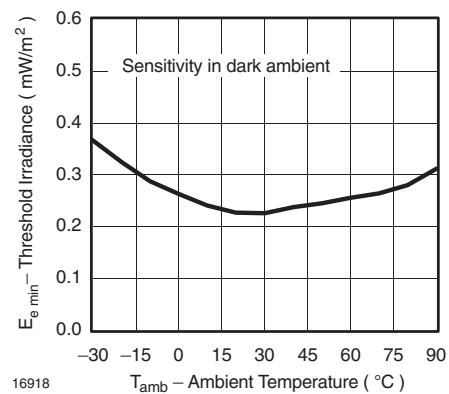

Figure 10. Sensitivity vs. Ambient Temperature

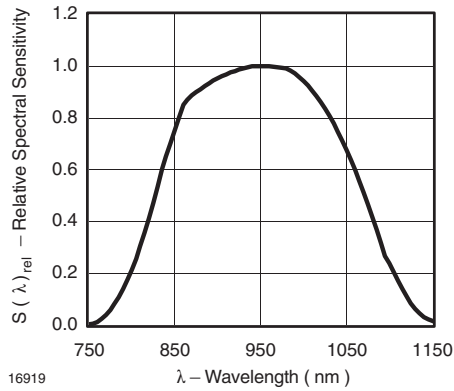

Figure 11. Relative Spectral Sensitivity vs. Wavelength

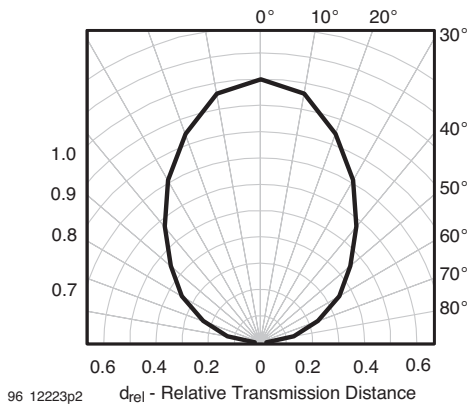

Figure 12. Directivity

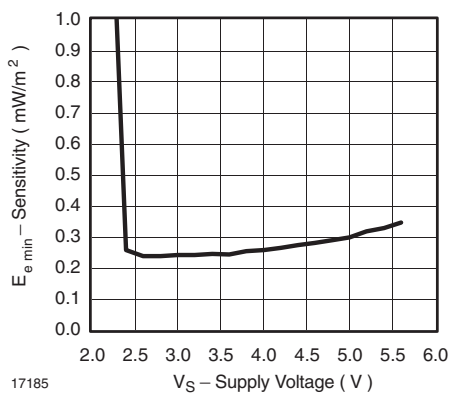

Figure 13. Sensitivity vs. Supply Voltage

Suitable Data Format

The circuit of the TSOP321.. is designed in that way that unexpected output pulses due to noise or disturbance signals are avoided. A bandpass filter, an integrator stage and an automatic gain control are used to suppress such disturbances.

The distinguishing mark between data signal and disturbance signal are carrier frequency, burst length and duty cycle.

The data signal should fulfill the following conditions:

- Carrier frequency should be close to center frequency of the bandpass (e.g. 38 kHz).
- Burst length should be 6 cycles/burst or longer.
- After each burst which is between 6 cycles and 70 cycles a gap time of at least 10 cycles is necessary.
- For each burst which is longer than 1.8 ms a corresponding gap time is necessary at some time in the data stream. This gap time should have at least same length as the burst.
- Up to 2200 short bursts per second can be received continuously.

Some examples for suitable data format are: NEC Code, Toshiba Micom Format, Sharp Code, RC5 Code, RC6 Code, RCMM Code, R-2000 Code, RECS-80 Code.

When a disturbance signal is applied to the TSOP321.. it can still receive the data signal. However the sensitivity is reduced to that level that no unexpected pulses will occur.

Some examples for such disturbance signals which are suppressed by the TSOP321.. are:

- DC light (e.g. from tungsten bulb or sunlight)
- Continuous signal at 38 kHz or at any other frequency
- Signals from fluorescent lamps with electronic ballast (an example of the signal modulation is in the figure below).

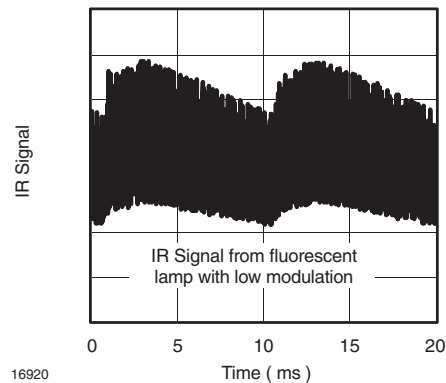
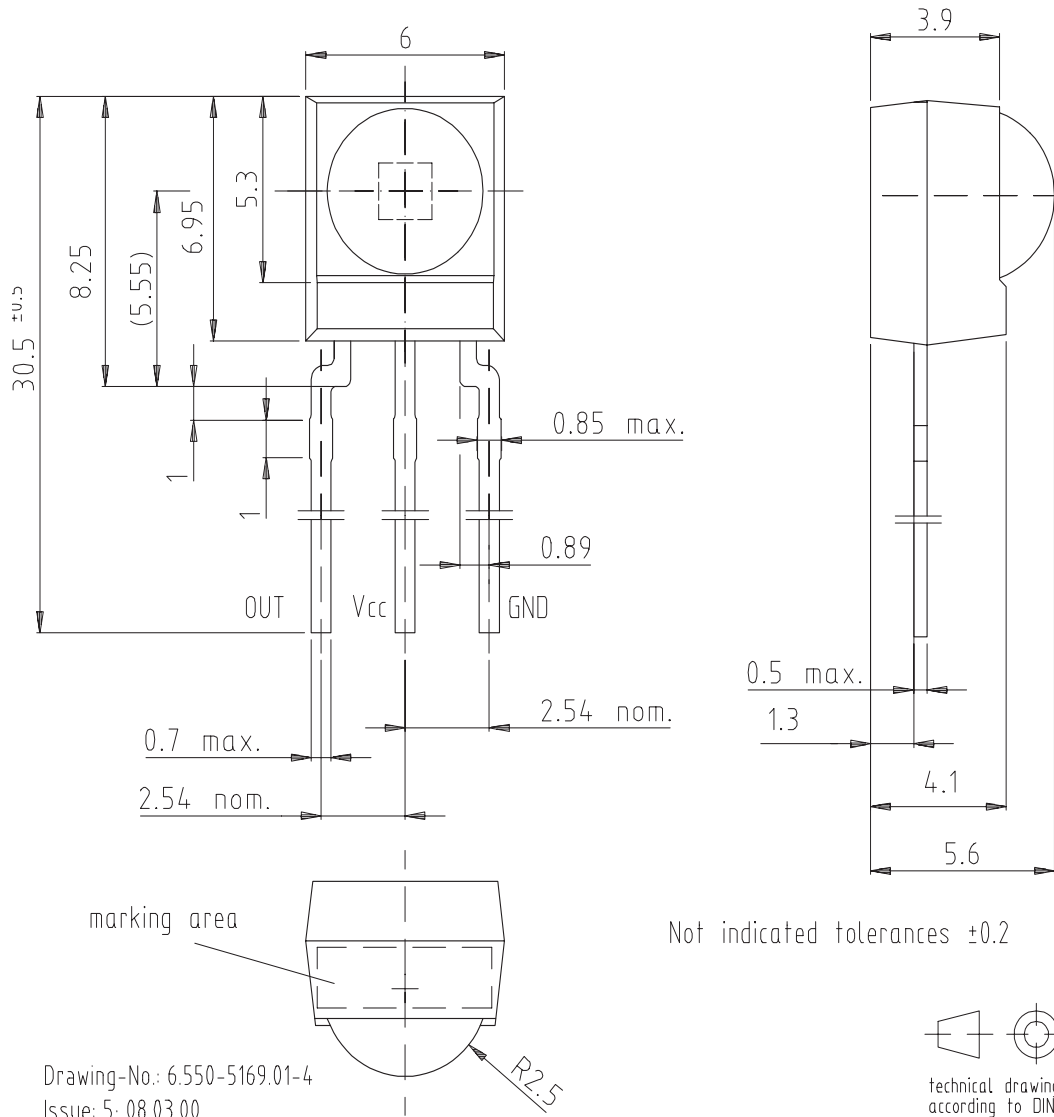

Figure 14. IR Signal from Fluorescent Lamp with low Modulation

Package Dimensions in mm



Drawing-No.: 6.550-5169.01-4
Issue: 5; 08.03.00

technical drawings
according to DIN
specifications

13655

Ozone Depleting Substances Policy Statement

It is the policy of **Vishay Semiconductor GmbH** to

1. Meet all present and future national and international statutory requirements.
2. Regularly and continuously improve the performance of our products, processes, distribution and operating systems with respect to their impact on the health and safety of our employees and the public, as well as their impact on the environment.

It is particular concern to control or eliminate releases of those substances into the atmosphere which are known as ozone depleting substances (ODSs).

The Montreal Protocol (1987) and its London Amendments (1990) intend to severely restrict the use of ODSs and forbid their use within the next ten years. Various national and international initiatives are pressing for an earlier ban on these substances.

Vishay Semiconductor GmbH has been able to use its policy of continuous improvements to eliminate the use of ODSs listed in the following documents.

1. Annex A, B and list of transitional substances of the Montreal Protocol and the London Amendments respectively
2. Class I and II ozone depleting substances in the Clean Air Act Amendments of 1990 by the Environmental Protection Agency (EPA) in the USA
3. Council Decision 88/540/EEC and 91/690/EEC Annex A, B and C (transitional substances) respectively.

Vishay Semiconductor GmbH can certify that our semiconductors are not manufactured with ozone depleting substances and do not contain such substances.

**We reserve the right to make changes to improve technical design
and may do so without further notice.**

Parameters can vary in different applications. All operating parameters must be validated for each customer application by the customer. Should the buyer use Vishay Semiconductors products for any unintended or unauthorized application, the buyer shall indemnify Vishay Semiconductors against all claims, costs, damages, and expenses, arising out of, directly or indirectly, any claim of personal damage, injury or death associated with such unintended or unauthorized use.

Vishay Semiconductor GmbH, P.O.B. 3535, D-74025 Heilbronn, Germany
Telephone: 49 (0)7131 67 2831, Fax number: 49 (0)7131 67 2423