

Model No.: PIS01E

General Description

The pyroelectric infrared sensor detects infrared radiation by making use of the property that the polarization of pyroelectric materials changes with temperature. Materials called ferroelectrics absorb thermal energy, which changes spontaneous polarization generating a surface electrical charge. The charge is proportional to polarization change. This phenomenon is called the pyroelectric effect. A pyrosensor using fine ceramic materials can detect even the slightest infrared energy charge, such as that from a human body.

Two compensated sensing elements are applied to suppress the interference due to temperature variation. As a result, the operating stability of the sensor is greatly improved. Therefore, dual element type is highly sensitive to human body movement while remaining insensitive to ambient temperature change, vibration or optical noise because of the dual configuration that electrically cancels such effects.

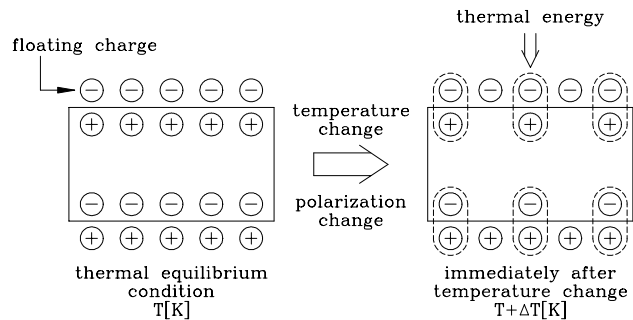

Configuration (Figure 1)

Field of View

(Figure 1-A)

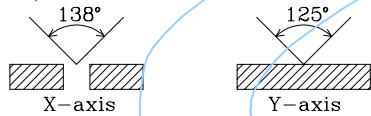

Top View

(Figure 1-B)

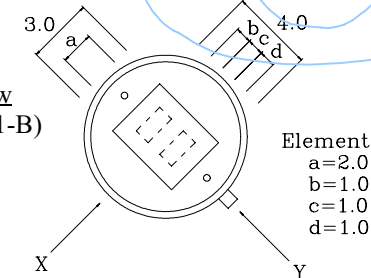

Side View

(Figures 1-C)

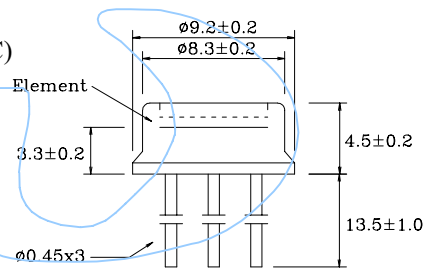

Base View

(Figure 1-D)

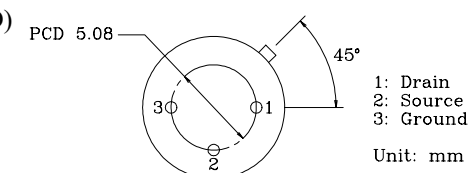

Electrical Characteristics

(Ta=25°C)

Item	Min.	Typ.	Max.	Unit	Remark
Element Geometry		2.0 X 1.0		mm ²	
Window	Substrate Thickness	Silicon 0.5		mm	
	Film	Si			
	Cut-On Wavelength	5.0 ± 0.5		μm	
	Average Transmission	75		%	
Pass Band	6.0~14.0		μm		
Signal Output	2.5	4.0		Vp-p	Note 2
Noise Output		90	250	mVp-p	Note 3
Field Of View	138 X 125			deg.	
Balance Output			15	%	Note 4
Detectivity	1.2X10 ⁷			cm·Hz ^{1/2} /W	Note 6
Noise Equivalent Power			1.1X10 ⁻⁸	W/Hz ^{1/2}	Note 7
Operating Voltage	3		10	VDC	Rs=47kΩ
Source Voltage	0.35		1.5	V	VD=5V, Rs=47kΩ
Frequency Response	0.3		3.0	Hz	Tolerance ±10dB
Operating Temperature	-20 ~ +60			°C	
Storage Temperature	-30 ~ +80			°C	

PIR Pyroelectric Infrared Sensor

Model No.: PIS01E

Reliability Standard

Item	Condition	Standard	
Humidity	60°C, 95%RH, 500hr.	Within $\pm 20\%$ of initial value. No remarkable damage. { Naturally normalized for 2hr at room temperature. }	
High Temperature Loading	85°C, 5V applied, 47k Ω load, 1000hr.		
Low Temperature Storage	-40°C, 1000hr.		
Thermal Shock	-10°C, 30min \leftrightarrow 50°C, 30minX100cycles		
Vibration	5V applied, 47k Ω load, 25 \pm 5°C, acceleration 1G each frequency 7.62 & 200Hz each direction X, Y & Z each 30 minutes.		
Lead Strength	1kg strain force along lead, 5sec.		
Soldering Test	260 \pm 5°C, 10 \pm 1sec lead to submerge into solder up to 1.5mm below stem.		
Hermetic Seal	160mmHg water, 1min.		No bubble visible.
Leakage	80 \pm 5°C, FC40, 1min according to MIL-STD-202E		No bubble visible. Within $\pm 20\%$ of initial value.

Frequency Characteristics

Frequency Characteristic of Amplifier

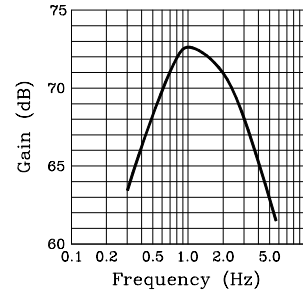

Frequency Characteristic of PIR Sensor

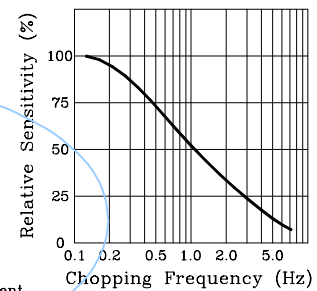

Directivity

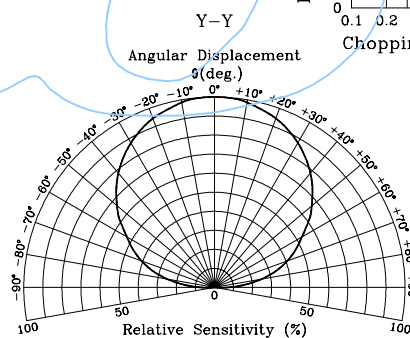
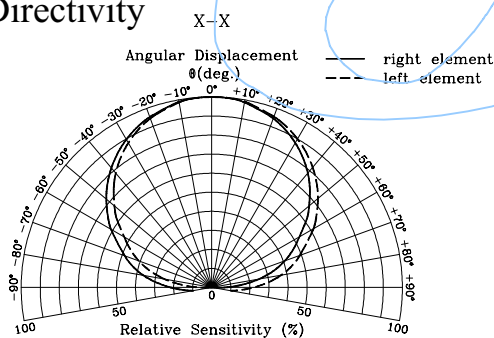

Application Circuit

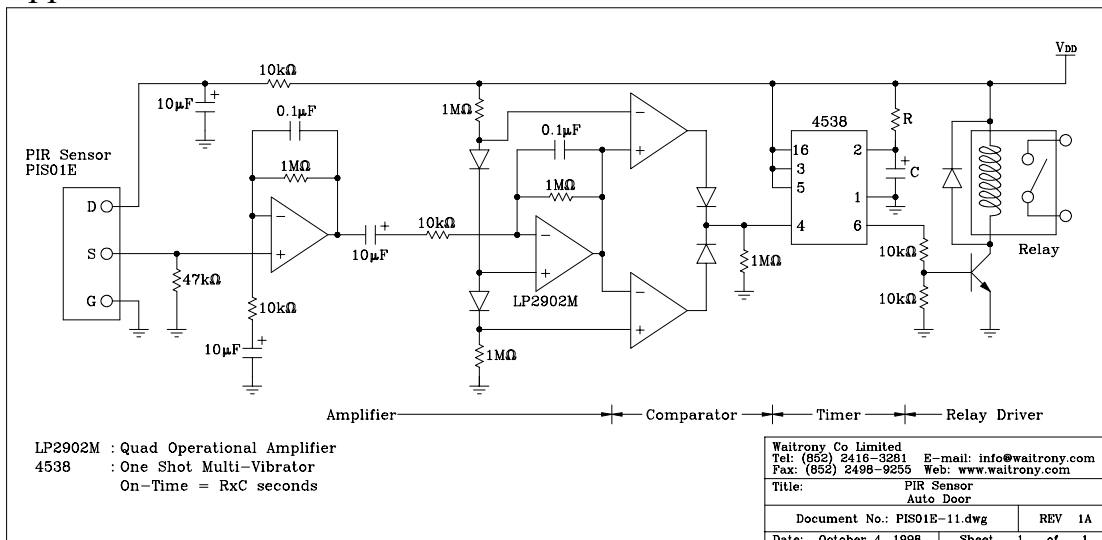

PIR Pyroelectric Infrared Sensor

Model No.: PIS01E

Lens

The detecting theory of PIR sensor to detect human body is by using two ceramic sensing elements. For example, when a human body appears from right to left, the infrared energy charge of the left sensing element is greater than that of right sensing element in a short period. And then a voltage potential difference occurs until the energy charge of both left and right sensing elements become back to Equilibrium State. In this case, the left sensing element will become Equilibrium State first and then next to the right elements. This detecting principle is also applied when a human body appears from left to right but this time the voltage potential difference is reversed and the right sensing element will become back to Equilibrium State first. Meanwhile, the ambient temperature change, vibration or optical noise is usually located at a fixed position or changing slowly. Therefore, the infrared energy charge of the left sensing element is equal to that of right element and hence the voltage potential difference is zero.

Referring to the above principle, in order to make the PIR sensor to detect human body more easily, a special lens is needed to create the strobe and null effect. The following are the common lenses for use with PIR sensor.

Lens -7708

Dimension:
(Unit: mm)

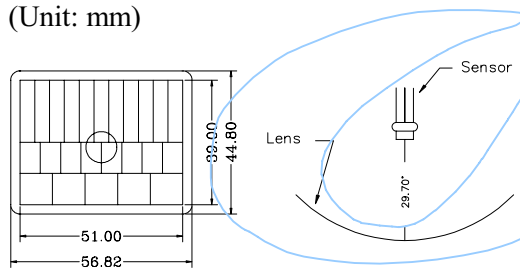

Detecting Area:
(Unit: meter)

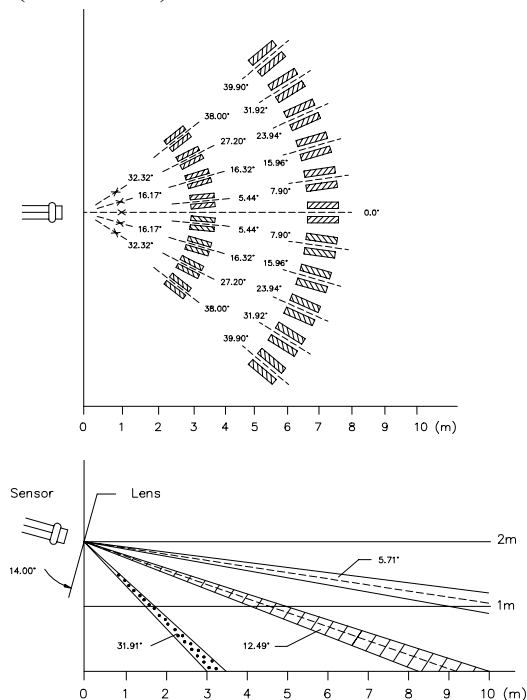

Lens -7709

Dimension:
(Unit: mm)

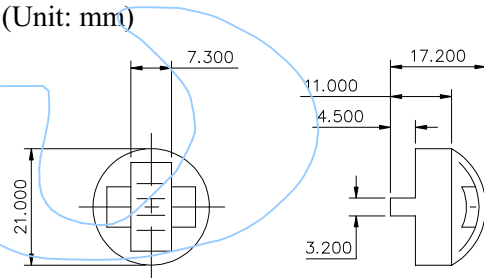

Detecting Area:
(Unit: meter)

