

# SP - 1CL3 · SP - 1CL3R2

The SP - 1CL3 is a high - sensitivity photodiode mounted in a 3ø low - cost ceramic package. The SP - 1CL3R2 photodiode, with daylight filter, is available in the same package.

**FEATURES**

- Compact (ø3mm)
- Wide angular response
- Low - cost

**APPLICATIONS**

- Optical counters
- Floppy disc drives
- Encoders

**DIMENSIONS**

(Unit : mm)

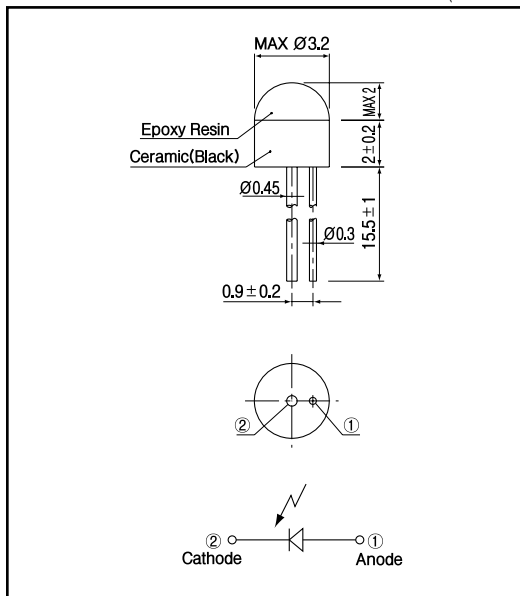

**MAXIMUM RATINGS**

(Ta=25 )

Item	Symbol	Rating	Unit
Reverse voltage	V <sub>r</sub>	20	V
Operating temp.	Topr.	- 25 ~ +90	
Storage temp.	Tstg.	- 30 ~ +100	
Soldering temp. *1	Tsol.	260	

\*1. For MAX.5 seconds at the position of 2 mm from the package

**ELECTRO-OPTICAL CHARACTERISTICS**

(Ta=25 )

Item	Symbol	Conditions	SP - 1CL3			SP - 1CL3R2			Unit.
			Min.	Typ.	Max.	Min.	Typ.	Max.	
Open circuit voltage	V <sub>oc</sub>	E <sub>v</sub> = 1,000lx *2		0.4			0.4		V
Short circuit current	I <sub>sc</sub>		8	15		5	15		µA
Dark current	I <sub>d</sub>	SP - 1CL3 SP - CL3R2 V <sub>r</sub> = 5V, V <sub>s</sub> = 1V			0.5			1	µA
Curve factor	C.F.		0.55			0.55			-
Capacitance	C <sub>t</sub>	V = 0V, f = 1MHz		50			50		pF
Temperature coefficient of V <sub>oc</sub>	t			- 2.2			- 2.2		mV/
Temperature coefficient of I <sub>sc</sub>	t			0.18			0.18		%/
Spectral sensitivity			450 ~ 1,050			700 ~ 1,050			nm
Peak wavelength	p		900			920			nm
Half angle			± 50			± 50			deg.

\*2. Color temp. = 2856K standard Tungsten lamp

**Photo diodes**

**SP - 1CL3 · SP - 1CL3R2**

**Light current Vs. Forward voltage**

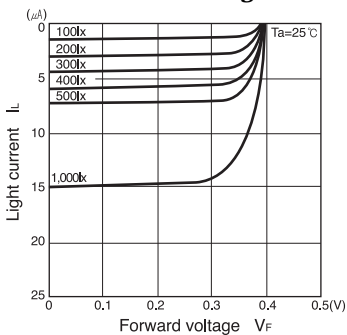

**Short circuit current Vs. Illuminance**

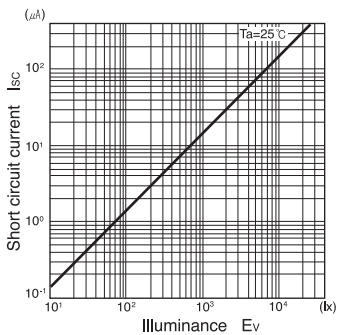

**Dark current Vs. Ambient temperature**

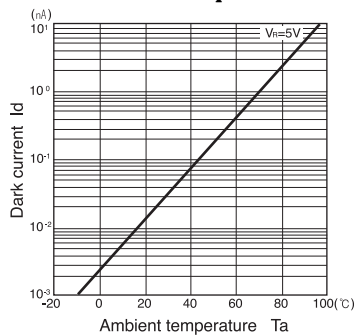

**Relative sensitivity Vs. Wavelength**

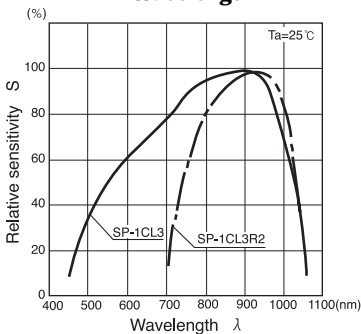

**Dark current Vs. Reverse voltage**

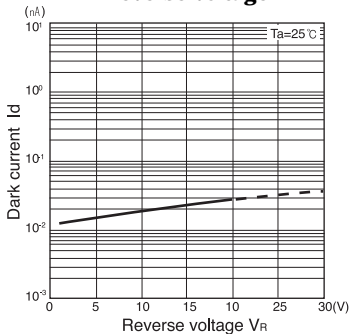

**Radiant Pattern**

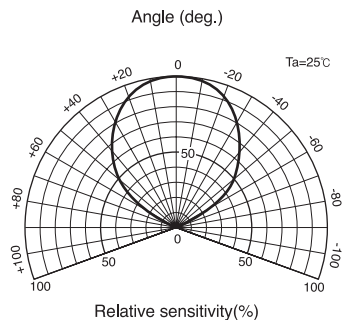

**Capacitance between terminals Vs. Reverse voltage**

