

SD - 201 · SD - 202

The SD - 201, 202 are position sensors for automatic focusing of camera.

FEATURES

- Laser beam focusing/positioning is best performed.
- High performance.
- High reliability in demanding environments.

APPLICATIONS

- Automatic focusing of camera

DIMENSIONS

(Unit : mm)

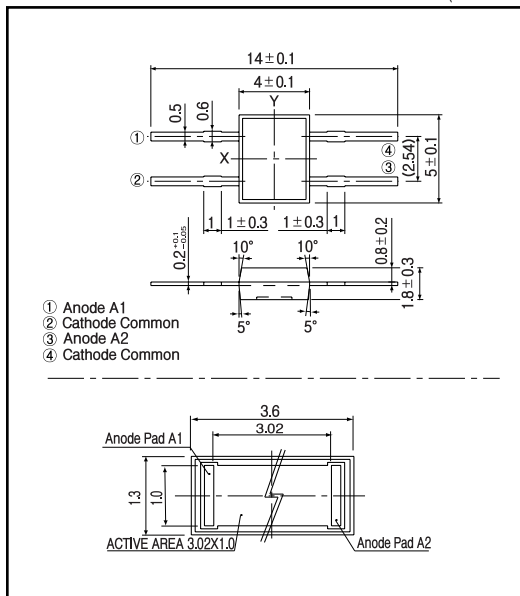

MAXIMUM RATINGS

(Ta=25)

Item	Symbol	Rating	Unit
Reverse voltage	V_R	30	V
Power dissipation	P_D	30	mW
Operating temp.	$T_{opr.}$	- 25 ~ + 85	
Storage temp.	$T_{stg.}$	- 30 ~ + 100	

ELECTRO-OPTICAL CHARACTERISTICS

(Ta=25)

Item	Symbol	Conditions	SD - 201			SD - 202			Unit.
			Min.	Typ.	Max.	Min.	Typ.	Max.	
Reverse voltage	V_R	$I_R = 10 \mu A$	30			30			V
Dark current	I_d	$V_R = 1V$			10			10	nA
Light current	I_L^{*1}	$V_R = 1V, E = 1000lx^5$	20	30		13	16		μA
Spectral sensitivity			400 ~ 1100			700 ~ 1100			nm
Peak wavelength	λ_p		940			940			nm
Switching speeds	t_r, t_f	$V_R = 1V, R_L = 1K$	2			2			$\mu sec.$
Capacitance	C_t	$V_R = 1V, f = 1MHz$	10			10			pF
Resistance	R_s^{*2}	$V_R = 1V, V_a = 0.5V$	100	150	200	100	150	200	K
Signal slope	*3	$V_R = 1V$	0.067			0.067			-
Light current difference	I_1/I_2^{*4}		± 2			± 2			%

*1. $I_1 = I_1 + I_2$ (I_1 = Light current of A1, I_2 = Light current of A2)

*2. V_a = Voltage of Anode A1, A2

*3. $^{*3} = 1(I_1 - I_2) / (I_1 + I_2) \times 100$

*4. $L = L_1 - L_2$

*5. Color temp. = 2856K standard Tungsten lamp

Position Sensitive Diode

SD - 201 · SD - 202

Power dissipation Vs. Ambient temperature

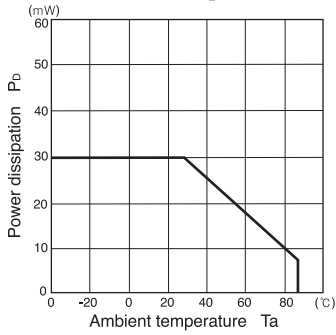

Light current Vs. Illuminance

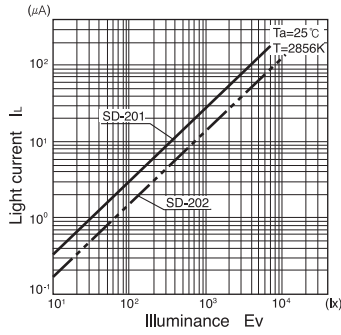

Relative sensitivity Vs. Wavelength

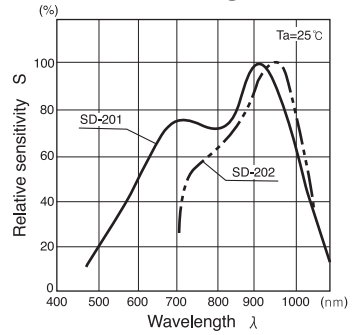

Relative light current Vs. Ambient temperature

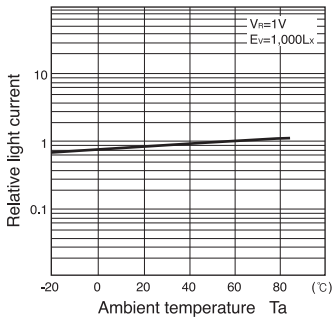

Relative resistance between electrodes Vs. Ambient temperature

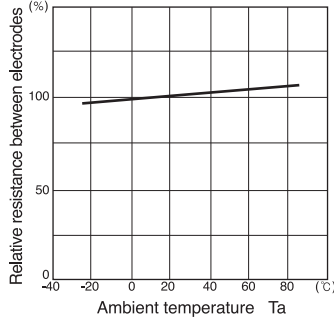

Dark current Vs. Ambient temperature

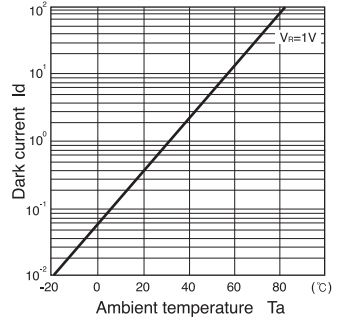

Dark current Vs. Reverse voltage

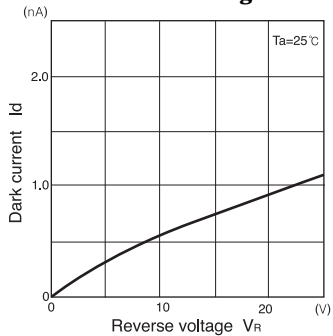

Capacitance between terminals Vs. Reverse voltage

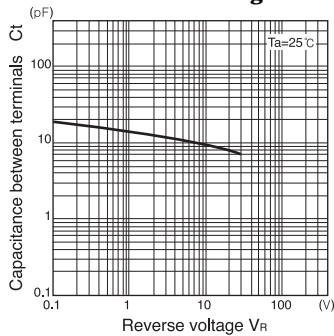

Relative light current Vs. Position

