

# Hyper TOPLED RG Hyper-Bright LED

## LW T773



### Besondere Merkmale

- **Gehäusetyp:** weißes SMT Gehäuse
- **Besonderheit des Bauteils:** extrem breite Abstrahlcharakteristik; ideal für Hinterleuchtungen; Bauteil wird top down montiert und strahlt durch das PCB
- **Farbort:**  $x = 0,32$ ,  $y = 0,31$  nach CIE 1931 (weiß)
- **Typische Farbtemperatur:** 6500 K
- **Farbwiedergabeindex:** 80
- **Abstrahlwinkel:** Lambertscher Strahler ( $120^\circ$ )
- **Technologie:** InGaN
- **optischer Wirkungsgrad:** 6 lm/W
- **Gruppierungsparameter:** Lichtstärke, Farbort
- **Verarbeitungsmethode:** für alle SMT-Bestücktechniken geeignet
- **Lötmethode:** IR Reflow Löten und Wellenlöten (TTW)
- **Vorbehandlung:** nach JEDEC Level 2
- **Gurtung:** 12 mm Gurt mit 2000/Rolle,  $\varnothing 180$  mm oder 8000/Rolle,  $\varnothing 330$  mm
- **ESD-Festigkeit:** ESD-sicher bis 2 kV nach EOS/ESD-5.1-1993

### Anwendungen

- Einkopplung in Lichtleiter
- Hinterleuchtung (LCD, Schalter, Tasten, Displays, Werbebeleuchtung, Allgemeinbeleuchtung)
- Innenbeleuchtung im Automobilbereich (z.B. Instrumentenbeleuchtung, u. ä.)
- Ersatz von Kleinst-Glühlampen
- Allgemeinbeleuchtung

### Features

- **package:** white SMT package
- **feature of the device:** extremely wide viewing angle; ideal for backlighting; LED is mounted top down and emits through the PCB
- **color coordinates:**  $x = 0.32$ ,  $y = 0.31$  acc. to CIE 1931 (white)
- **typ. color temperature:** 6500 K
- **color reproduction index:** 80
- **viewing angle:** Lambertian Emitter ( $120^\circ$ )
- **technology:** InGaN
- **optical efficiency:** 6 lm/W
- **grouping parameter:** luminous intensity, color coordinates
- **assembly methods:** suitable for all SMT assembly methods
- **soldering methods:** IR reflow soldering and TTW soldering
- **preconditioning:** acc. to JEDEC Level 2
- **taping:** 12 mm tape with 2000/reel,  $\varnothing 180$  mm or 8000/reel,  $\varnothing 330$  mm
- **ESD-withstand voltage:** up to 2 kV acc. to EOS/ESD-5.1-1993

### Applications

- coupling into light guides
- backlighting (LCD, switches, keys, displays, illuminated advertising, general lighting)
- interior automotive lighting (e.g. dashboard backlighting, etc.)
- substitution of micro incandescent lamps
- general lighting

Typ	Emissions- farbe	Farbe der Lichtaustritts- fläche	Lichtstärke	Lichtstrom	Bestellnummer
Type	Color of Emission	Color of the Light Emitting Area	Luminous Intensity $I_F = 20 \text{ mA}$ $I_V \text{ (mcd)}$	Luminous Flux $I_F = 20 \text{ mA}$ $\Phi_V \text{ (mlm)}$	Ordering Code
LW T773-Q2R2-1	white	colored	90 ... 180	405 (typ.)	Q62703-Q4951
LW T773-R2S2-1		diffused	140 ... 280	630 (typ.)	Q62703-Q4952

Anm.: -1 Farbselektiert nach Farbortgruppen, Lieferung in Einzelgruppen(siehe **Seite 5**)

*Die Standardlieferform von Serientypen beinhaltet eine untere bzw. eine obere Familiengruppe, die aus nur 3 bzw. 4 Halbgruppen besteht. Einzelne Halbgruppen sind nicht erhältlich.  
In einer Verpackungseinheit / Gurt ist immer nur eine Halbgruppe enthalten.*

Note: -1 Color selection acc. to chromaticity coordinate groups, delivery in single groups (see **page 5**)

*The standard shipping format for serial types includes a lower or upper family group of 3 or 4 individual groups. Individual half groups are not available.  
No packing unit / tape ever contains more than one luminous intensity half group.*

**Grenzwerte**  
**Maximum Ratings**

Bezeichnung Parameter	Symbol Symbol	Wert Value	Einheit Unit
Betriebstemperatur Operating temperature range	$T_{op}$	- 40 ... + 100	°C
Lagertemperatur Storage temperature range	$T_{stg}$	- 40 ... + 100	°C
Sperrschichttemperatur Junction temperature	$T_j$	+ 110	°C
Durchlassstrom Forward current	$I_F$	20	mA
Stoßstrom Surge current $t \leq 10 \mu s, D = 0.005$	$I_{FM}$	200	mA
Sperrspannung Reverse voltage	$V_R$	5	V
Leistungsaufnahme Power consumption $T_A \leq 25 \text{ °C}$	$P_{tot}$	85	mW
Wärmewiderstand Thermal resistance Sperrschicht/Umgebung Junction/ambient	$R_{th JA}$	400	K/W
Sperrschicht/Löt看pad Junction/solder point Montage auf PC-Board FR 4 (Padgröße $\geq 16 \text{ mm}^2$ ) mounted on PC board FR 4 (pad size $\geq 16 \text{ mm}^2$ )	$R_{th JS}$	180	K/W

**Kennwerte** ( $T_A = 25\text{ °C}$ )**Characteristics**

Bezeichnung Parameter	Symbol Symbol	Wert Value	Einheit Unit
Farbkoordinate x nach CIE 1931 <sup>1)</sup> (typ.) Chromaticity coordinate x acc. to CIE 1931 $I_F = 20\text{ mA}$	x	0.32	–
Farbkoordinate y nach CIE 1931 <sup>1)</sup> (typ.) Chromaticity coordinate y acc. to CIE 1931 $I_F = 20\text{ mA}$	y	0.31	–
Abstrahlwinkel bei 50 % $I_V$ (Vollwinkel) (typ.) Viewing angle at 50 % $I_V$	$2\phi$	120	Grad deg.
Durchlassspannung <sup>2)</sup> (typ.) Forward voltage (max.) $I_F = 20\text{ mA}$	$V_F$ $V_F$	3.5 4.2	V V
Sperrstrom (typ.) Reverse current (max.) $V_R = 5\text{ V}$	$I_R$ $I_R$	0.01 10	$\mu\text{A}$ $\mu\text{A}$
Temperaturkoeffizient von x (typ.) Temperature coefficient of x $I_F = 20\text{ mA}; -10\text{ °C} \leq T \leq 100\text{ °C}$	$TC_x$	–0.1	$10^{-3}/\text{K}$
Temperaturkoeffizient von y (typ.) Temperature coefficient of y $I_F = 20\text{ mA}; -10\text{ °C} \leq T \leq 100\text{ °C}$	$TC_y$	–0.2	$10^{-3}/\text{K}$
Temperaturkoeffizient von $V_F$ (typ.) Temperature coefficient of $V_F$ $I_F = 20\text{ mA}; -10\text{ °C} \leq T \leq 100\text{ °C}$	$TC_V$	– 3.0	mV/K
Optischer Wirkungsgrad (typ.) Optical efficiency $I_F = 20\text{ mA}$	$\eta_{\text{opt}}$	6	lm/W

<sup>1)</sup> Farbortgruppen werden mit einer Stromeinprägedauer von 25 ms und einer Genauigkeit von  $\pm 0,01$  ermittelt.  
Chromaticity coordinate groups are tested at a current pulse duration of 25 ms and a tolerance of  $\pm 0.01$ .

<sup>2)</sup> Spannungswerte werden mit einer Stromeinprägedauer von 1 ms und einer Genauigkeit von  $\pm 0,1\text{ V}$  ermittelt.  
Voltages are tested at a current pulse duration of 1 ms and a tolerance of  $\pm 0.1\text{ V}$ .

1) Farbortgruppen  
Chromaticity coordinate groups

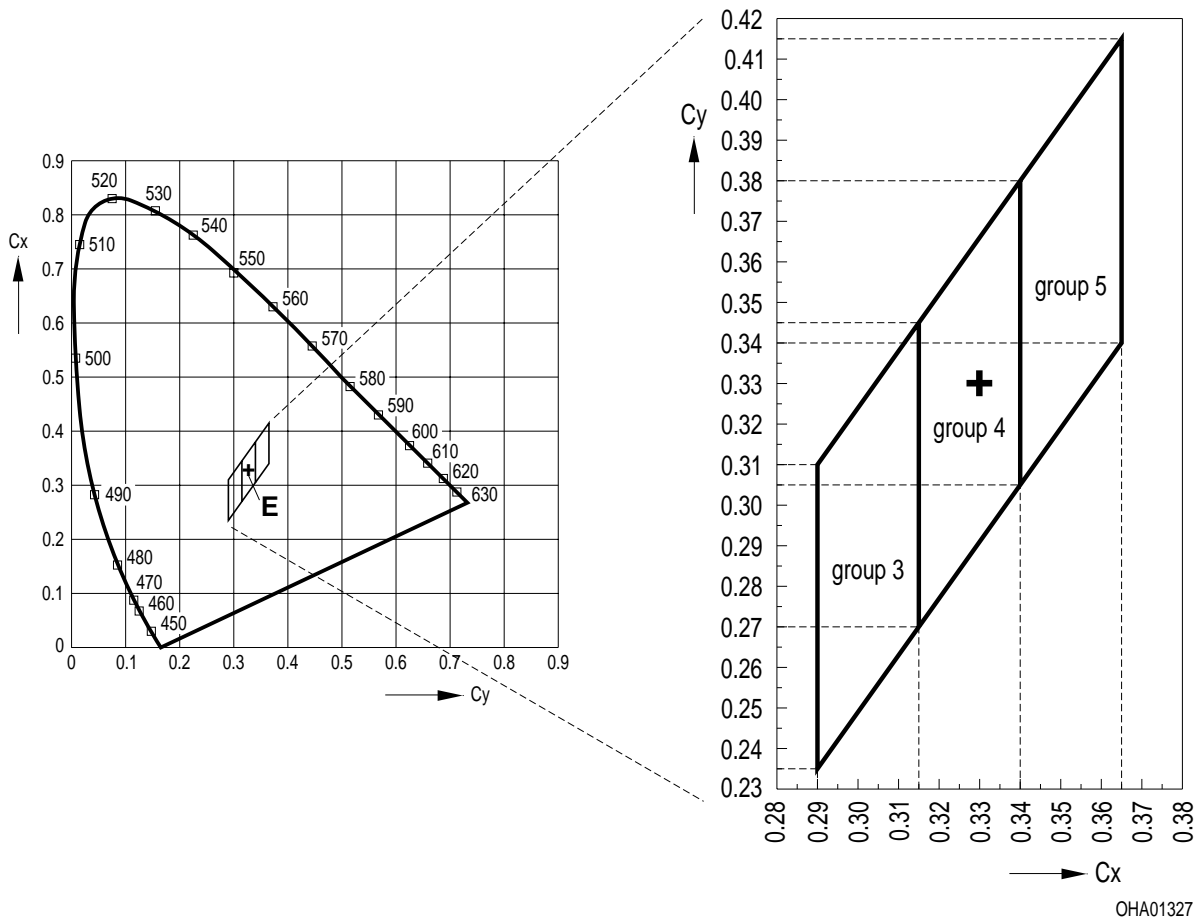

**Helligkeits-Gruppierungsschema**  
**Luminous Intensity Groups**

<b>Lichtgruppe</b> <b>Luminous Intensity Group</b>	<b>Lichtstärke</b> <b>Luminous Intensity</b> <b><math>I_V</math> (mcd)</b>	<b>Lichtstrom</b> <b>Luminous Flux</b> <b><math>\Phi_V</math> (lm)</b>
Q2	90 ... 112	300 (typ.)
R1	112 ... 140	380 (typ.)
R2	140 ... 180	480 (typ.)
S1	180 ... 224	600 (typ.)
S2	224 ... 280	760 (typ.)

Helligkeitswerte werden mit einer Stromeinprägedauer von 25 ms und einer Genauigkeit von  $\pm 11\%$  ermittelt.  
 Luminous intensity is tested at a current pulse duration of 25 ms and a tolerance of  $\pm 11\%$ .

**Gruppenbezeichnung auf Etikett**
**Group Name on Label**

Beispiel: R2-4

Example: R2-4

<b>Lichtgruppe</b> <b>Luminous Intensity Group</b>	<b>Halbgruppe</b> <b>Half Group</b>	<b>Farbortgruppe</b> <b>Chromaticity Coordinate Group</b>
R	2	4

Relative spektrale Emission  $I_{\text{rel}} = f(\lambda)$ ,  $T_A = 25\text{ °C}$ ,  $I_F = 20\text{ mA}$

### Relative Spectral Emission

$V(\lambda)$  = spektrale Augenempfindlichkeit

Standard eye response curve

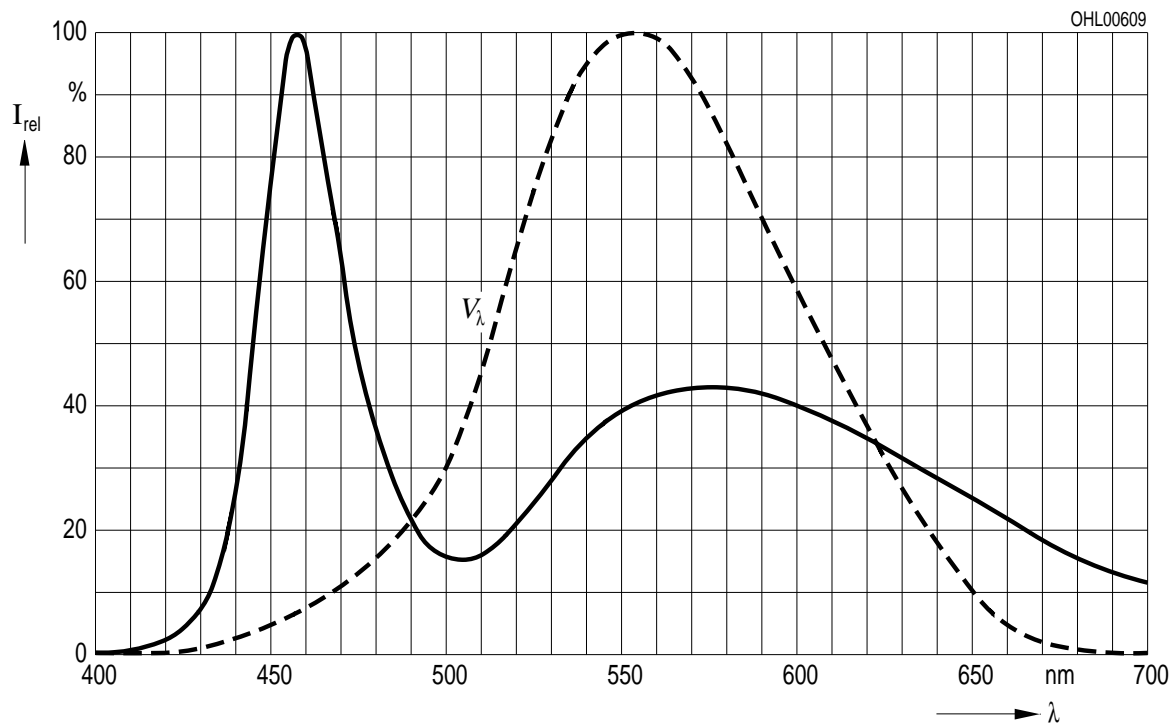

Abstrahlcharakteristik  $I_{\text{rel}} = f(\varphi)$

### Radiation Characteristic

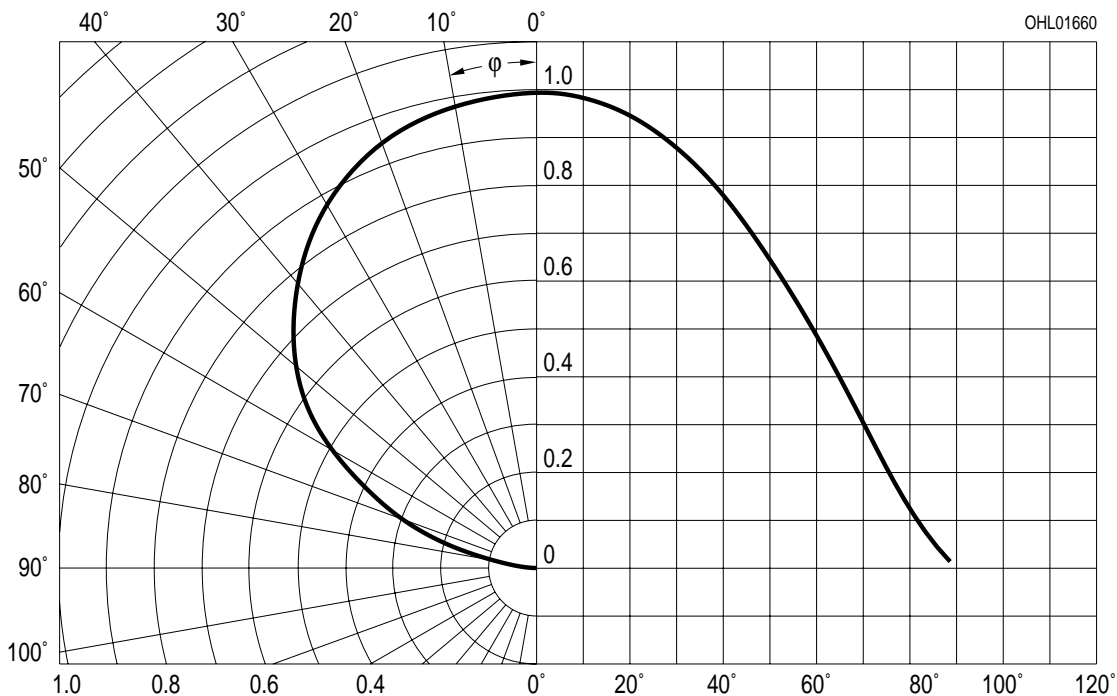

**Durchlassstrom  $I_F = f(V_F)$**

**Forward Current**

$T_A = 25\text{ °C}$

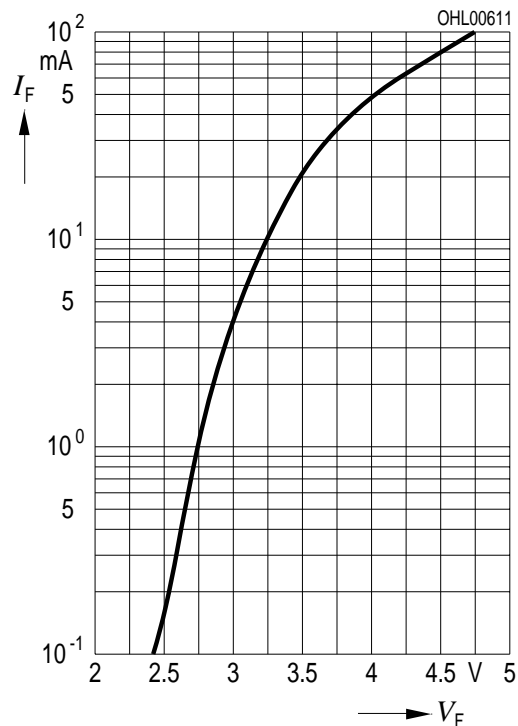

**Relative Lichtstärke  $I_V/I_{V(20\text{ mA})} = f(I_F)$**

**Relative Luminous Intensity**

$T_A = 25\text{ °C}$

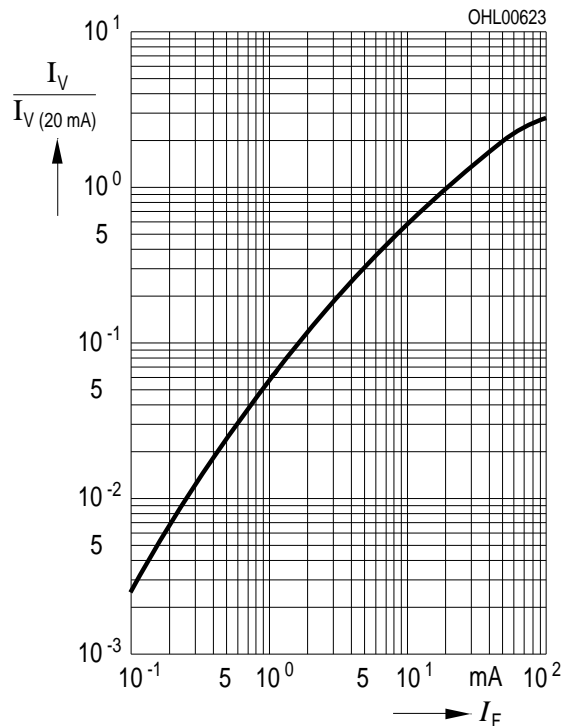

**Maximal zulässiger Durchlassstrom  $I_F = f(T)$**

**Max. Permissible Forward Current**

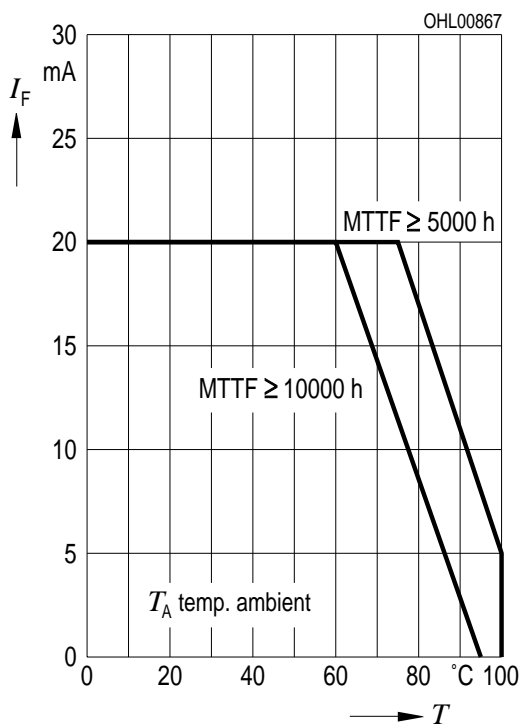

**Maximal zulässiger Durchlassstrom  $I_F = f(T)$**

**Max. Permissible Forward Current**

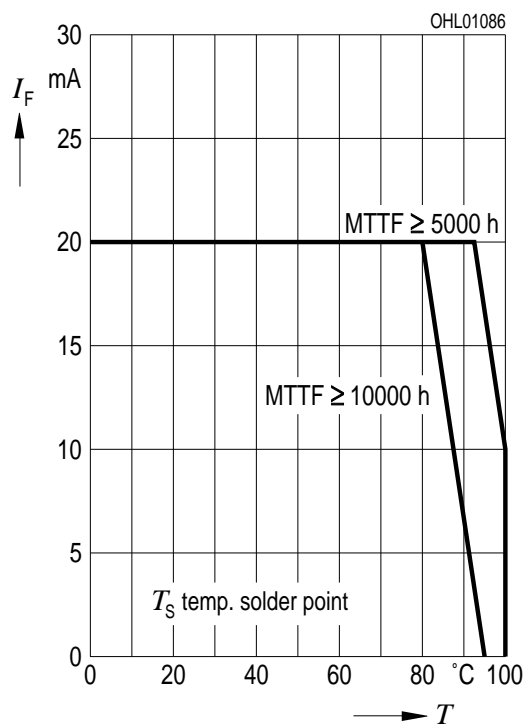



**Relative Lichtstärke  $I_V/I_{V(25\text{ °C})} = f(T_A)$**   
**Relative Luminous Intensity**

$I_F = 20\text{ mA}$

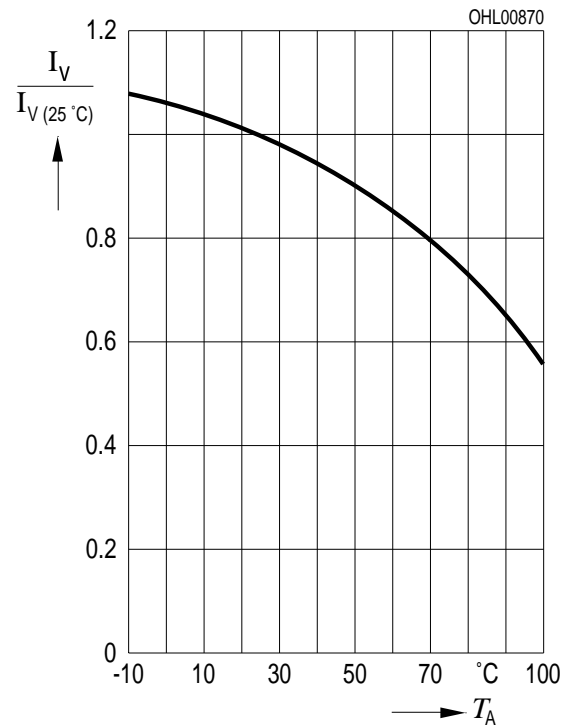

**Farbortverschiebung  $x, y = f(I_F)$**   
**Chromaticity Coordinate Shift**

$T_A = 25\text{ °C}$

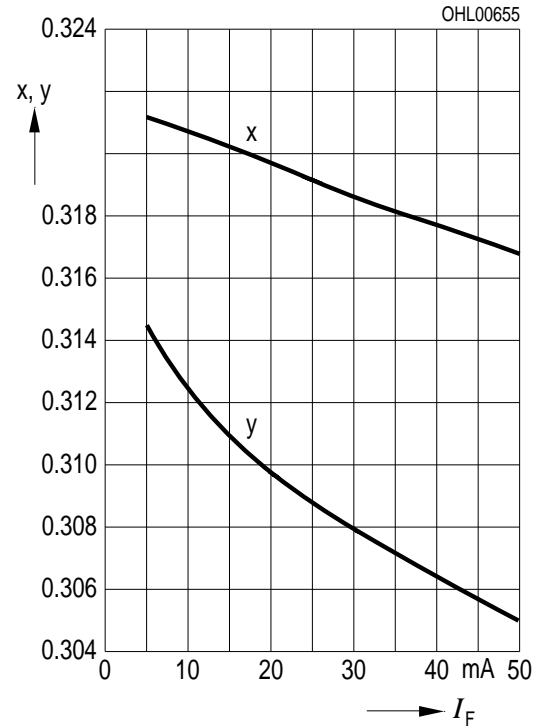

**Zulässige Impulsbelastbarkeit  $I_F = f(t_p)$**   
**Permissible Pulse Handling Capability**  
 Duty cycle  $D =$  parameter,  $T_A = 25\text{ °C}$   
**LW**

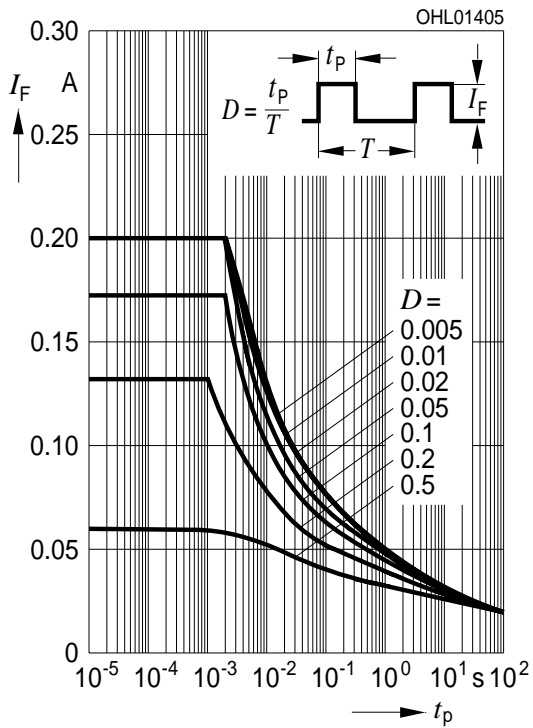

**Zulässige Impulsbelastbarkeit  $I_F = f(t_p)$**   
**Permissible Pulse Handling Capability**  
 Duty cycle  $D =$  parameter,  $T_A = 85\text{ °C}$   
**LW**

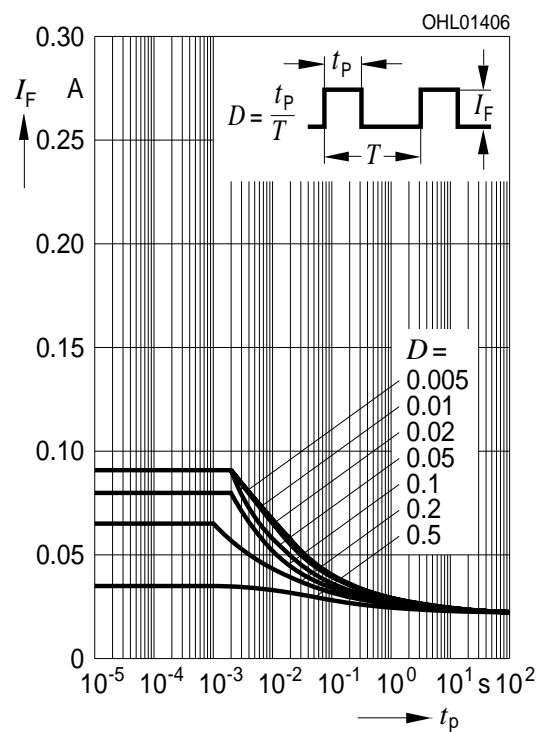

**Maßzeichnung**  
**Package Outlines**

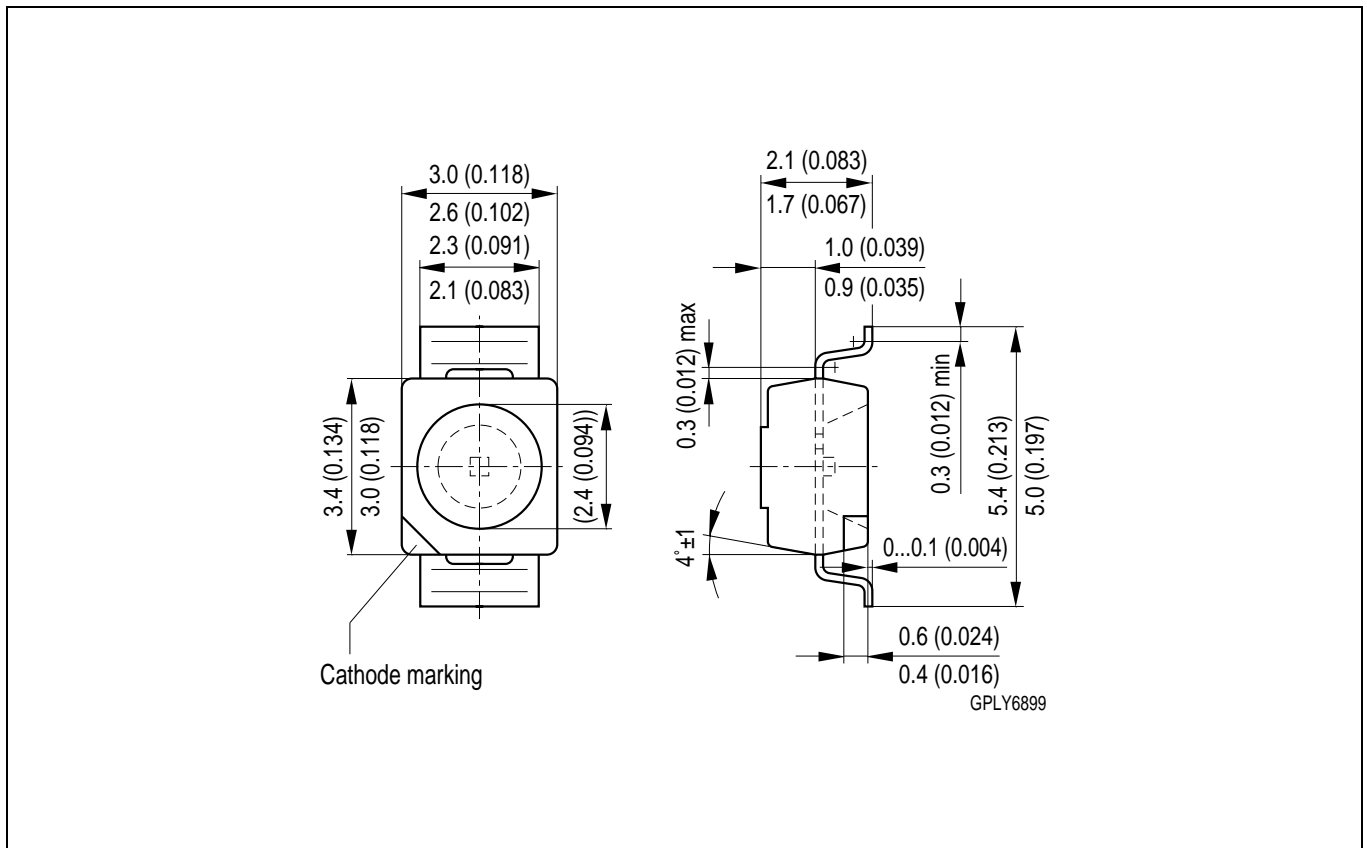

Maße werden wie folgt angegeben: mm (inch) / Dimensions are specified as follows: mm (inch).

**Kathodenkennung:** abgeschrägte Ecke  
**Cathode mark:** bevelled edge  
**Gewicht / Approx. weight:** 40 mg

**Lötbedingungen** Vorbehandlung nach JEDEC Level 2  
**Soldering Conditions** Preconditioning acc. to JEDEC Level 2

**IR-Reflow Lötprofil** (nach IPC 9501)  
**IR Reflow Soldering Profile** (acc. to IPC 9501)

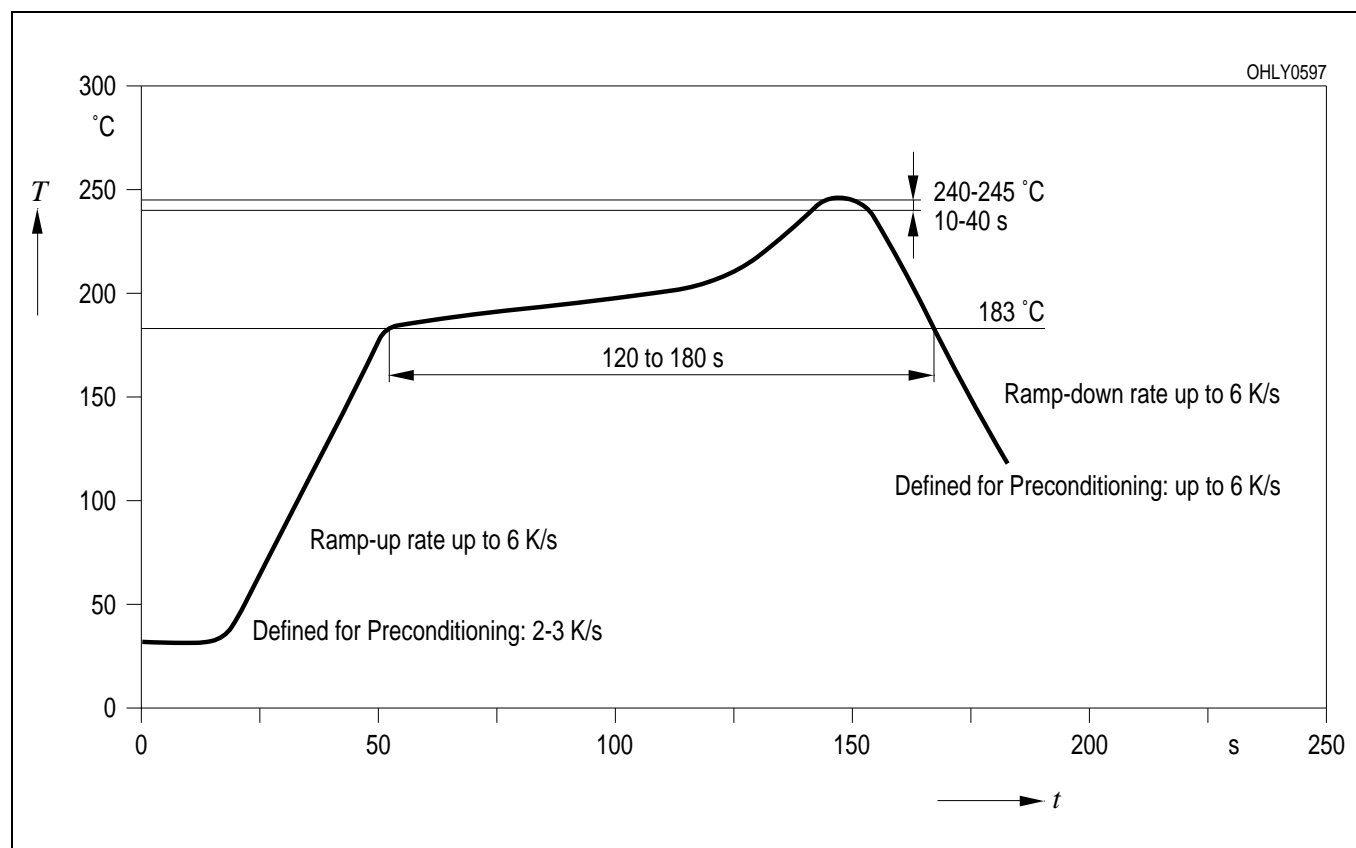

**Wellenlöten (TTW)** (nach CECC 00802)  
**TTW Soldering** (acc. to CECC 00802)

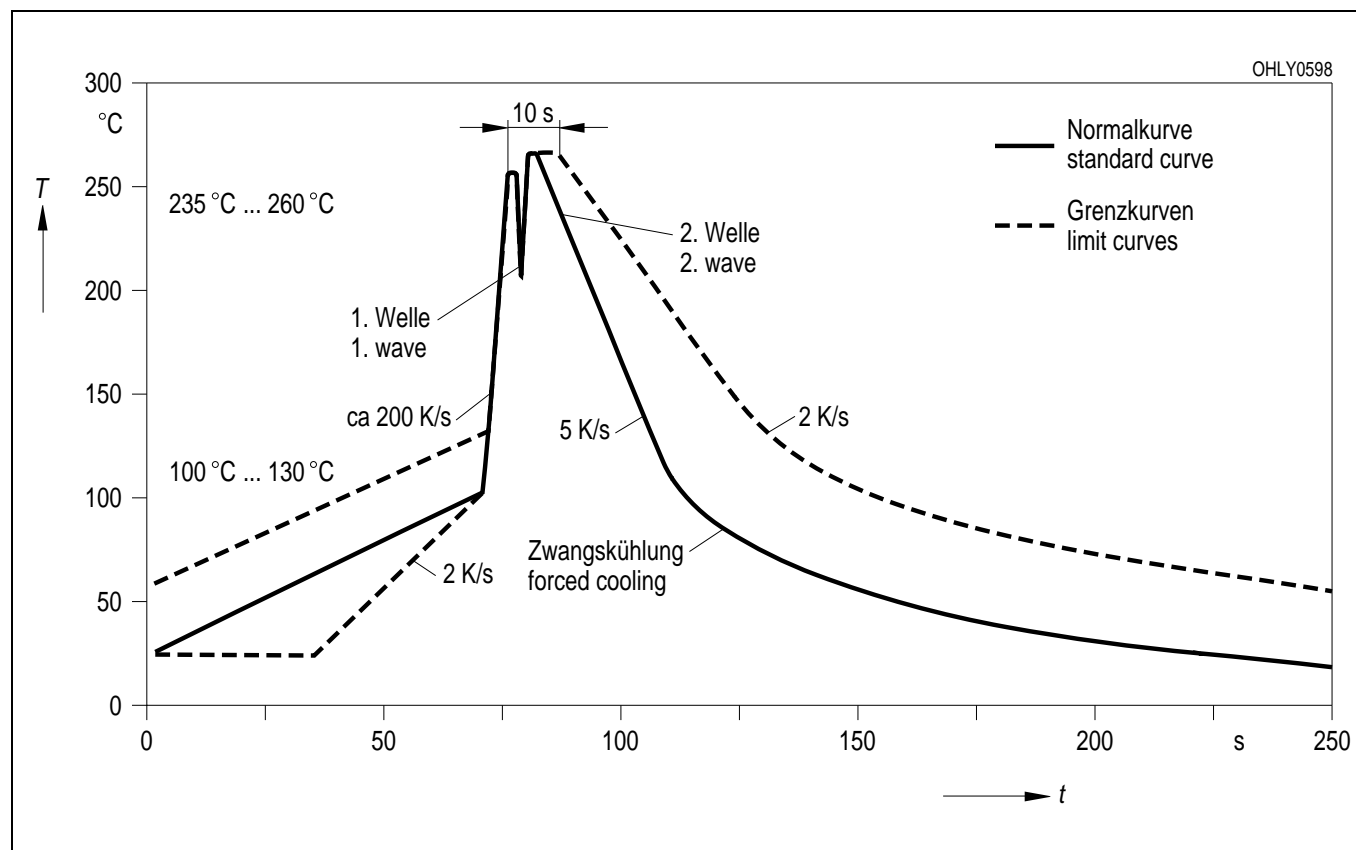

**Empfohlenes Lötpaddesign** IR Reflow Löten / Wellenlöten (TTW)  
**Recommended Solder Pad** IR Reflow Soldering / TTW soldering

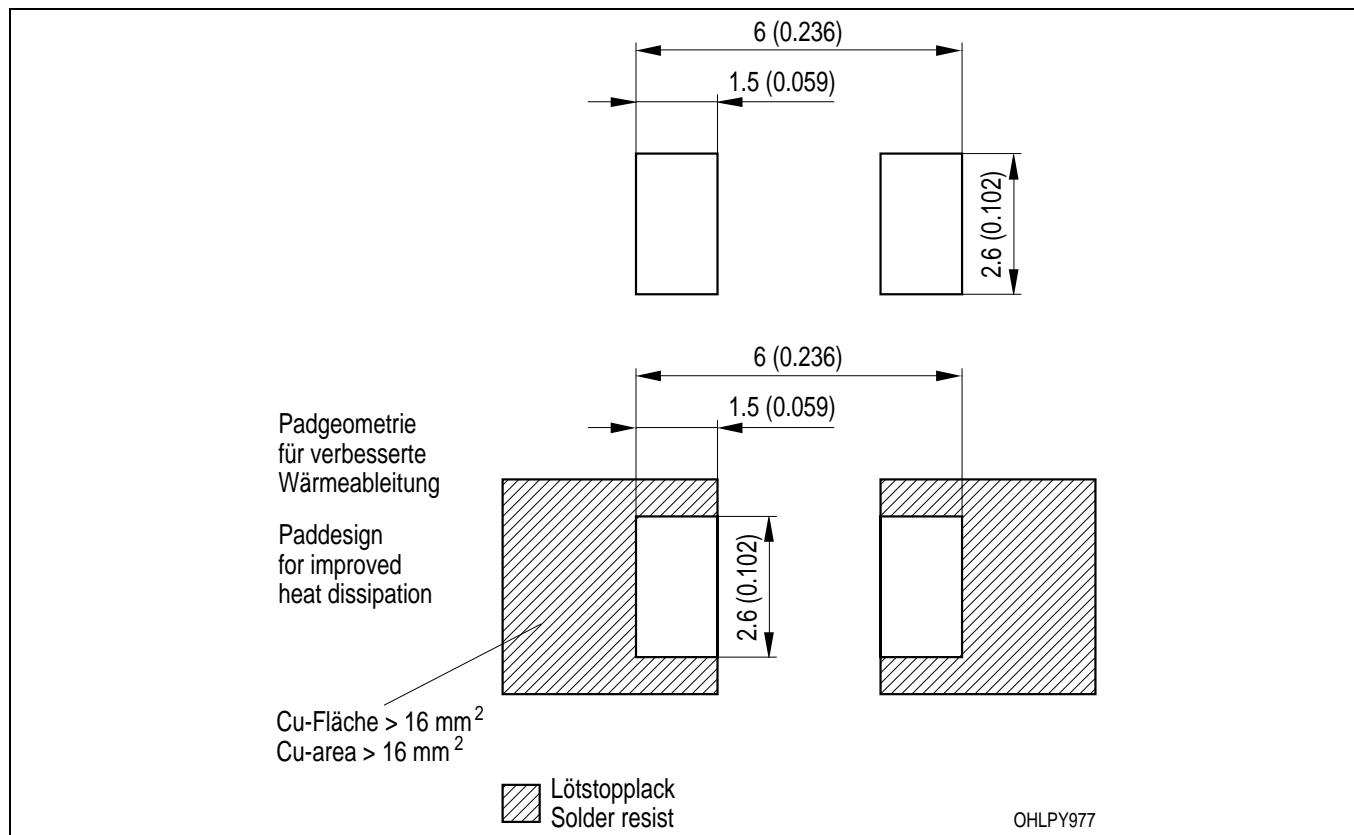

Maße werden wie folgt angegeben: mm (inch) / Dimensions are specified as follows: mm (inch).

**Gurtung / Polarität und Lage**

Verpackungseinheit 2000/Rolle, ø180 mm  
 oder 8000/Rolle, ø330 mm

**Method of Taping / Polarity and Orientation**

Packing unit 2000/reel, ø180 mm  
 or 8000/reel, ø330 mm

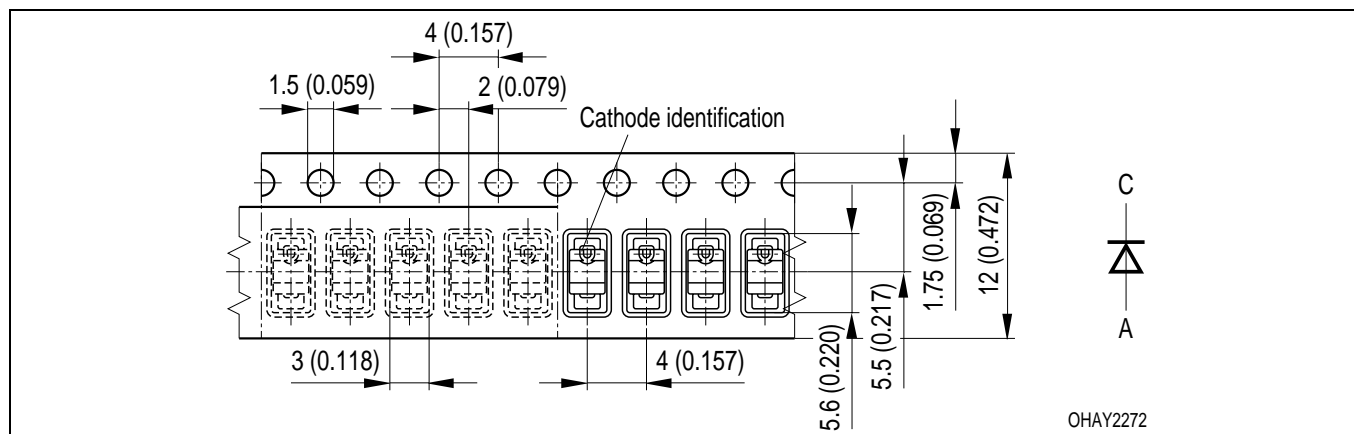

Maße werden wie folgt angegeben: mm (inch) / Dimensions are specified as follows: mm (inch).

**Revision History: 2001-10-02**

Previous Version: 2001-02-28

Page	Subjects (major changes since last revision)
4	value (forward voltage)

**Patent List****Patent No.**

US 6 066 861, US 6 277 301

**Published by OSRAM Opto Semiconductors GmbH & Co. OHG****Wernerwerkstrasse 2, D-93049 Regensburg****© All Rights Reserved.****Attention please!**

The information describes the type of component and shall not be considered as assured characteristics.

Terms of delivery and rights to change design reserved. Due to technical requirements components may contain dangerous substances. For information on the types in question please contact our Sales Organization.

If printed or downloaded, please find the latest version in the Internet.

**Packing**

Please use the recycling operators known to you. We can also help you – get in touch with your nearest sales office. By agreement we will take packing material back, if it is sorted. You must bear the costs of transport. For packing material that is returned to us unsorted or which we are not obliged to accept, we shall have to invoice you for any costs incurred.

**Components used in life-support devices or systems must be expressly authorized for such purpose!** Critical components <sup>1</sup> may only be used in life-support devices or systems <sup>2</sup> with the express written approval of OSRAM OS.

<sup>1</sup> A critical component is a component used in a life-support device or system whose failure can reasonably be expected to cause the failure of that life-support device or system, or to affect its safety or the effectiveness of that device or system.

<sup>2</sup> Life support devices or systems are intended (a) to be implanted in the human body, or (b) to support and/or maintain and sustain human life. If they fail, it is reasonable to assume that the health of the user may be endangered.