

3 mm (T1) LED, Non Diffused

LS 3340, LO 3340, LY 3340, LG 3330, LP 3340



Besondere Merkmale

- **Gehäusetyp:** eingefärbtes, klares 3 mm (T1) Gehäuse
- **Besonderheit des Bauteils:** Lötspieße mit Aufsetzebene
- **Wellenlänge:** 628 nm (super-rot), 606 nm (orange), 587 nm (gelb), 570 nm (grün), 560 nm (pure green)
- **Abstrahlwinkel:** 50°
- **Technologie:** GaAlP (super-rot, orange, gelb, grün), GaP (pure green)
- **optischer Wirkungsgrad:** 1,5 lm/W (super-rot, orange, gelb), 2,5 lm/W (grün), 0,6 lm/W (pure green)
- **Gruppierungsparameter:** Lichtstärke
- **Lötmethode:** Wellenlöten (TTW)
- **Verpackung:** Schüttgut, gegurtet lieferbar

Anwendungen

- optischer Indikator
- Hinterleuchtung (LCD, Handy, Schalter, Tasten, Displays, Werbebeleuchtung, Allgemeinbeleuchtung)
- Signal- und Symbolleuchten
- Markierungsbeleuchtung (z.B. Stufen, Fluchtwege, u.ä.)
- Innenbeleuchtung im Automobilbereich (z.B. Instrumentenbeleuchtung, u.ä.)
- Leuchtschriftanzeigen

Features

- **package:** colored, clear 3 mm (T1) package
- **feature of the device:** solder leads with stand-off
- **wavelength:** 628 nm (super-red), 606 nm (orange), 587 nm (yellow), 570 nm (green), 560 nm (pure green)
- **viewing angle:** 50°
- **technology:** GaAlP (super-red, orange, yellow, green), GaP (pure green)
- **optical efficiency:** 1.5 lm/W (super-red, orange, yellow), 2.5 lm/W (green), 0.6 lm/W (pure green)
- **grouping parameter:** luminous intensity
- **soldering methods:** TTW soldering
- **packing:** bulk, available taped on reel

Applications

- optical indicators
- backlighting (LCD, cellular phones, switches, keys, displays, illuminated advertising, general lighting)
- signal and symbol luminaire
- marker lights (e.g. steps, exit ways, etc.)
- interior automotive lighting (e.g. dashboard backlighting, etc.)
- light writing displays

LS 3340, LO 3340, LY 3340, LG 3330, LP 3340

Typ Type	Emissions- farbe Color of Emission	Gehäuse- farbe Color of Package	Lichtstärke Luminous Intensity $I_F = 10 \text{ mA}$ $I_V \text{ (mcd)}$	Lichtstrom Luminous Flux $I_F = 10 \text{ mA}$ $\Phi_V \text{ (lm)}$	Bestellnummer Ordering Code
LS 3340-KN LS 3340-L LS 3340-M LS 3340-LP	super-red	red clear	7.1 ... 45.0 11.2 ... 18.0 18.0 ... 28.0 11.2 ... 71.0	35 (typ.) 20 (typ.) 30 (typ.) 55 (typ.)	Q62703Q1701 Q62703Q1702 Q62703Q1704 Q62703Q3223
LO 3340-KN LO 3340-L LO 3340-M LO 3340-N LO 3340-MP	orange	orange clear	7.1 ... 45.0 11.2 ... 18.0 18.0 ... 28.0 28.0 ... 45.0 18 ... 71.0	35 (typ.) 20 (typ.) 30 (typ.) 45 (typ.) 60 (typ.)	Q62703Q1886 Q62703Q2256 Q62703Q2255 Q62703Q2473 Q62703Q2628
LY 3340-JM LY 3340-M LY 3340-N LY 3340-LP	yellow	yellow clear	4.5 ... 28.0 18.0 ... 28.0 28.0 ... 45.0 11.2 ... 71.0	20 (typ.) 30 (typ.) 45 (typ.) 55 (typ.)	Q62703Q1789 Q62703Q1999 Q62703Q2652 Q62703Q1792
LG 3330-KN LG 3330-N LG 3330-P LG 3330-LP	green	colorless clear	7.1 ... 45.0 28.0 ... 45.0 45.0 ... 71.0 11.2 ... 71.0	35 (typ.) 45 (typ.) 70 (typ.) 55 (typ.)	Q62703Q1698 Q62703Q2010 Q62703Q4873 Q62703Q2011
LP 3340-JL LP 3340-K LP 3340-KM	pure green	green clear	4.5 ... 18.0 7.1 ... 11.2 7.1 ... 28.0	15 (typ.) 12 (typ.) 24 (typ.)	Q62703Q2749 Q62703Q2982 Q62703Q3211

Anm.: Die Standardlieferform von Serientypen beinhaltet eine untere bzw. eine obere Familiengruppe oder mindestens zwei Einzelgruppen.

In einer Verpackungseinheit / Gurt ist immer nur eine Helligkeitsgruppe enthalten.

Die technologiebedingte Helligkeits-Streuung der heutigen LED-Herstellprozesse über einen längeren Fertigungszeitraum (Halbleitermaterial - Chipherstellung - Montageprozess) erlaubt keine Zusage einer einzelnen Helligkeitsgruppe. Daher müssen mindestens zwei Helligkeitsgruppen vorgesehen werden!

Note: The standard shipping format for serial types includes a lower or upper family group or at least two individual groups.

No packing unit / tape ever contains more than one luminous intensity group.

Luminosity variations caused by the technology used in current LED manufacturing processes over a protracted manufacturing period (semiconductor material - chip fabrication - assembly process) mean that it is not possible to assign LEDs to a single luminous intensity group. For this reason at least two luminous intensity groups must be provided!

Grenzwerte
Maximum Ratings

Bezeichnung Parameter	Symbol Symbol	Wert Value		Einheit Unit
		LS, LO, LY, LG	LP	
Betriebstemperatur Operating temperature range	T_{op}	- 55 ... + 100		°C
Lagertemperatur Storage temperature range	T_{stg}	- 55 ... + 100		°C
Sperrschichttemperatur Junction temperature	T_j	+ 100		°C
Durchlassstrom Forward current	I_F	40	30	mA
Stoßstrom Surge current $t \leq 10 \mu s, D = 0.005$	I_{FM}	0.5		A
Sperrspannung ¹⁾ Reverse voltage	V_R	12		V
Leistungsaufnahme Power consumption $T_A \leq 25 \text{ °C}$	P_{tot}	130	95	mW
Wärmewiderstand ²⁾ Thermal resistance Sperrschicht/Umgebung Junction/ambient Sperrschicht/Löt看pad Junction/soldering point Montage auf PC-Board FR 4 (Padgröße $\geq 16 \text{ mm}^2$) mounted on PC board FR 4 (pad size $\geq 16 \text{ mm}^2$) Minimale Beinchenlänge Minimum lead length	$R_{th JA}$ $R_{th JS}$	400 180		K/W K/W

¹⁾ für kurzzeitigen Betrieb geeignet / suitable for short term application

²⁾ R_{th} erhöht sich um 13 K/W pro mm Beinchenlänge.
Each additional 1 mm of lead length increases R_{th} by 13 K/W.

Kennwerte ($T_A = 25\text{ °C}$)

Characteristics

Bezeichnung Parameter	Symbol Symbol	Wert Value					Einheit Unit
		LS	LO	LY	LG	LP	
Wellenlänge des emittierten Lichtes Wavelength at peak emission $I_F = 10\text{ mA}$	(typ.) λ_{peak}	635	610	586	572	557	nm
Dominantwellenlänge ¹⁾ Dominant wavelength $I_F = 10\text{ mA}$	(typ.) λ_{dom}	628	606	587	570	560	nm
Spektrale Bandbreite bei 50 % $I_{\text{rel max}}$ Spectral bandwidth at 50 % $I_{\text{rel max}}$ $I_F = 10\text{ mA}$	(typ.) $\Delta\lambda$	45	40	45	25	22	nm
Abstrahlwinkel bei 50 % I_V (Vollwinkel) Viewing angle at 50 % I_V	(typ.) 2ϕ	50	50	50	50	50	Grad deg.
Durchlassspannung ²⁾ Forward voltage $I_F = 10\text{ mA}$	(typ.) V_F (max.) V_F	2.0 2.5	2.0 2.5	2.0 2.5	2.0 2.5	2.0 2.5	V V
Sperrstrom Reverse current $V_R = 12\text{ V}$	(typ.) I_R (max.) I_R	0.01 10	0.01 10	0.01 10	0.01 10	0.01 10	μA μA
Temperaturkoeffizient von λ_{peak} Temperature coefficient of λ_{peak} $I_F = 10\text{ mA}; -10\text{ °C} \leq T \leq 100\text{ °C}$	(typ.) $TC_{\lambda_{\text{peak}}}$	0.11	0.12	0.10	0.11	0.11	nm/K
Temperaturkoeffizient von λ_{dom} Temperature coefficient of λ_{dom} $I_F = 10\text{ mA}; -10\text{ °C} \leq T \leq 100\text{ °C}$	(typ.) $TC_{\lambda_{\text{dom}}}$	0.07	0.07	0.07	0.07	0.05	nm/K
Temperaturkoeffizient von V_F Temperature coefficient of V_F $I_F = 10\text{ mA}; -10\text{ °C} \leq T \leq 100\text{ °C}$	(typ.) TC_V	-1.9	-1.9	-1.9	-1.4	-2.1	mV/K
Optischer Wirkungsgrad Optical efficiency $I_F = 10\text{ mA}$	(typ.) η_{opt}	1.5	1.5	1.5	2.5	0.6	lm/W

¹⁾ Wellenlängen werden mit einer Stromeinprägedauer von 25 ms und einer Genauigkeit von $\pm 1\text{ nm}$ ermittelt.
Wavelengths are tested at a current pulse duration of 25 ms and a tolerance of $\pm 1\text{ nm}$.

²⁾ Spannungswerte werden mit einer Stromeinprägedauer von 1 ms und einer Genauigkeit von $\pm 0,1\text{ V}$ ermittelt.
Voltages are tested at a current pulse duration of 1 ms and a tolerance of $\pm 0.1\text{ V}$.

Helligkeits-Gruppierungsschema
Luminous Intensity Groups

Lichtgruppe Luminous Intensity Group	Lichtstärke Luminous Intensity I_v (mcd)	Lichtstrom Luminous Flux Φ_v (mlm)
J	4.50 ... 7.10	8 (typ.)
K	7.10 ... 11.20	12 (typ.)
L	11.20 ... 18.00	20 (typ.)
M	18.00 ... 28.00	30 (typ.)
N	28.00 ... 45.00	45 (typ.)
P	45.00 ... 71.00	78 (typ.)

Helligkeitswerte werden mit einer Stromeinprägedauer von 25 ms und einer Genauigkeit von $\pm 11\%$ ermittelt.
 Luminous intensity is tested at a current pulse duration of 25 ms and a tolerance of $\pm 11\%$.

Relative spektrale Emission $I_{rel} = f(\lambda)$, $T_A = 25\text{ °C}$, $I_F = 10\text{ mA}$

Relative Spectral Emission

$V(\lambda)$ = spektrale Augenempfindlichkeit

Standard eye response curve

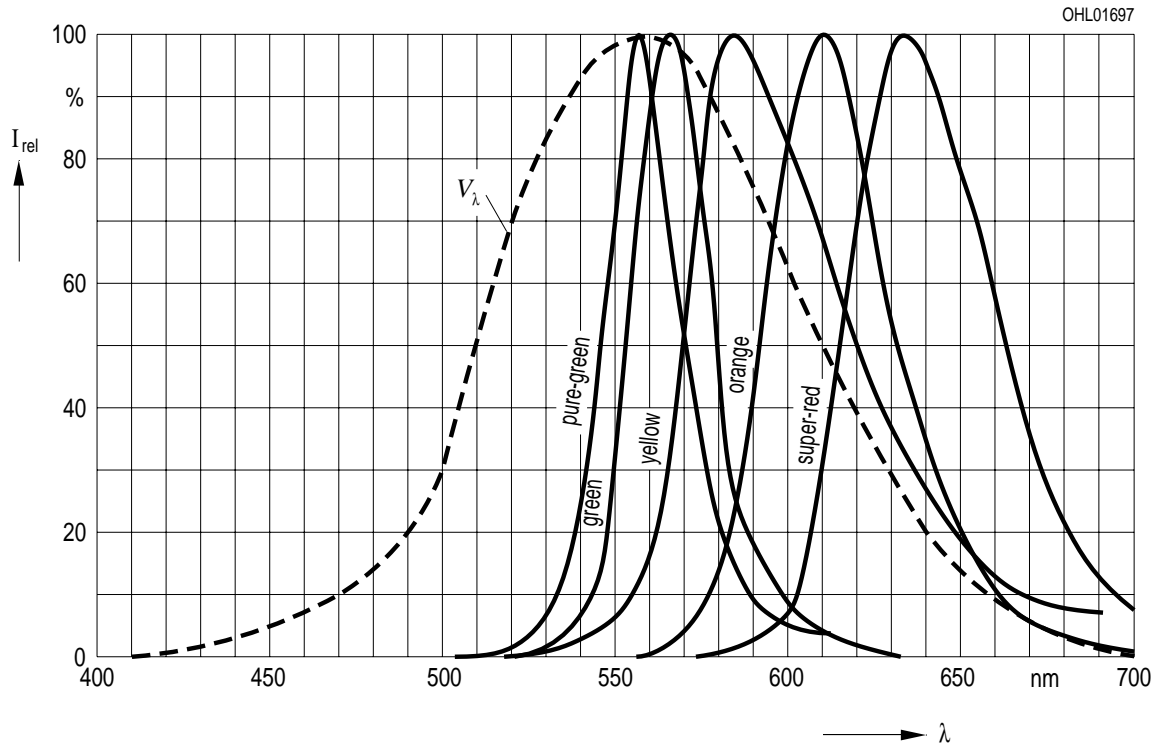

Abstrahlcharakteristik $I_{rel} = f(\varphi)$

Radiation Characteristic

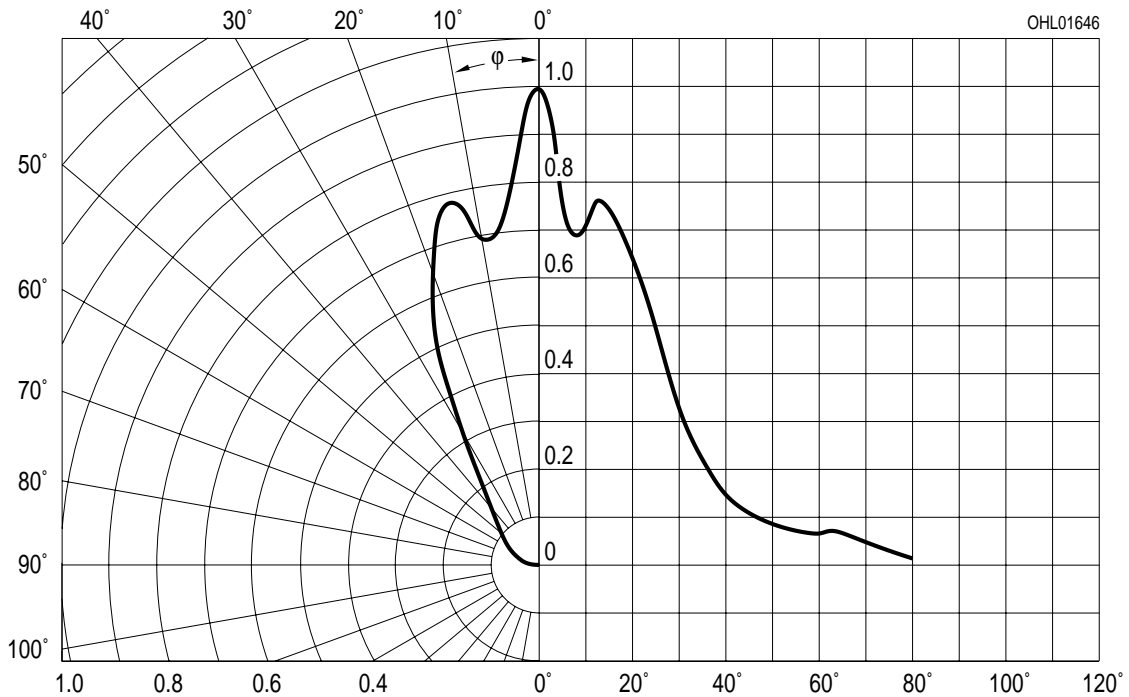

Durchlassstrom $I_F = f(V_F)$
Forward Current

$T_A = 25\text{ }^\circ\text{C}$

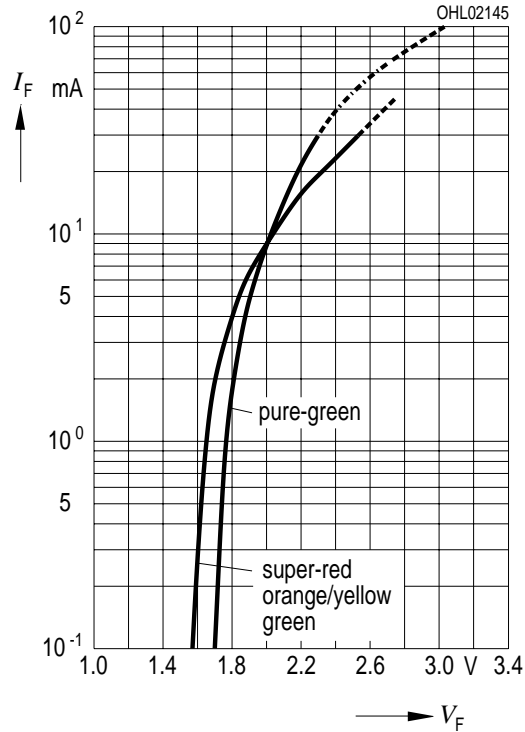

Relative Lichtstärke $I_V/I_{V(10\text{ mA})} = f(I_F)$
Relative Luminous Intensity

$T_A = 25\text{ }^\circ\text{C}$

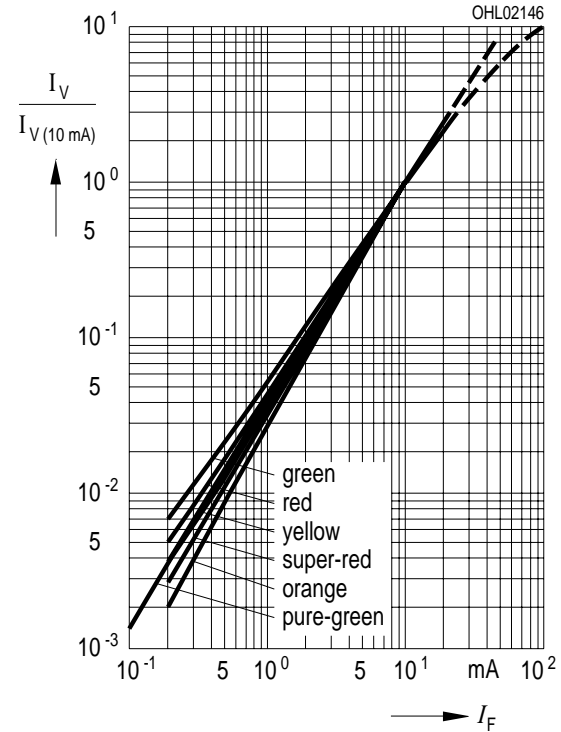

Maximal zulässiger Durchlassstrom $I_F = f(T)$
Max. Permissible Forward Current
LS, LO, LY, LG

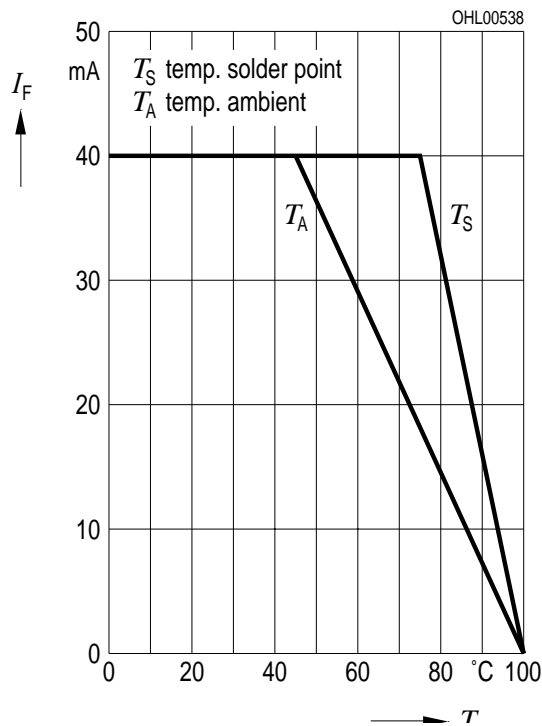

Maximal zulässiger Durchlassstrom $I_F = f(T)$
Max. Permissible Forward Current
LP

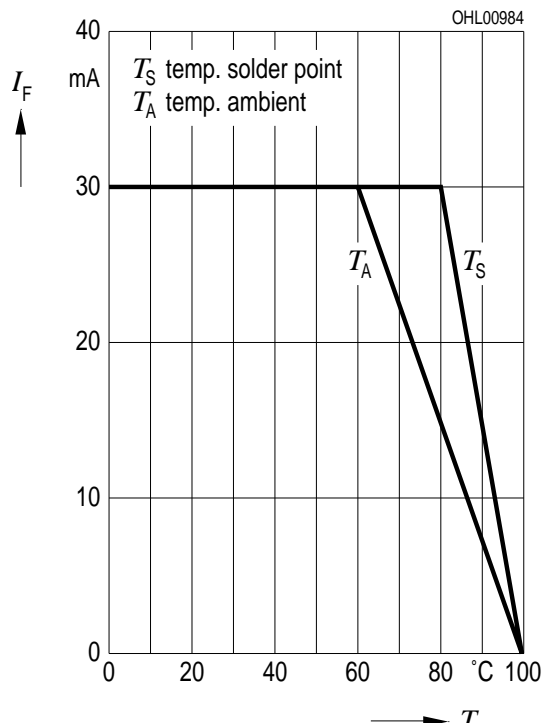

Relative Lichtstärke $I_V/I_{V(25\text{ °C})} = f(T_A)$
 Relative Luminous Intensity $I_F = 10\text{ mA}$

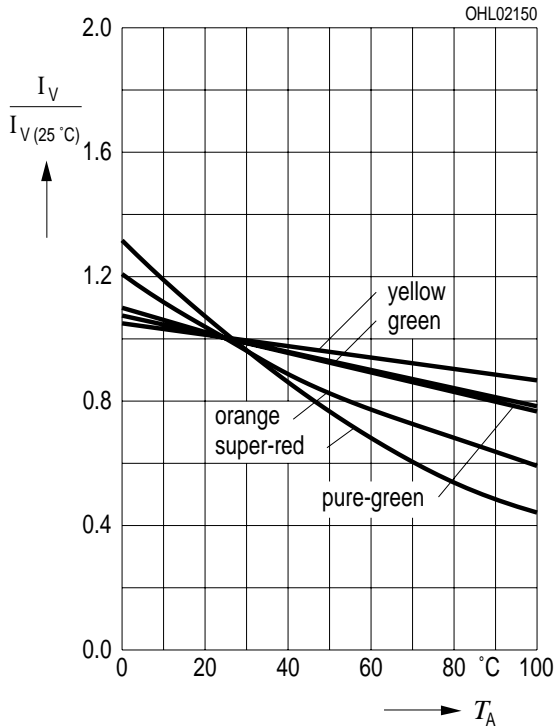

Zulässige Impulsbelastbarkeit $I_F = f(t_p)$
 Permissible Pulse Handling Capability
 Duty cycle $D = \text{parameter}$, $T_A = 25\text{ °C}$
 LS, LO, LY, LG

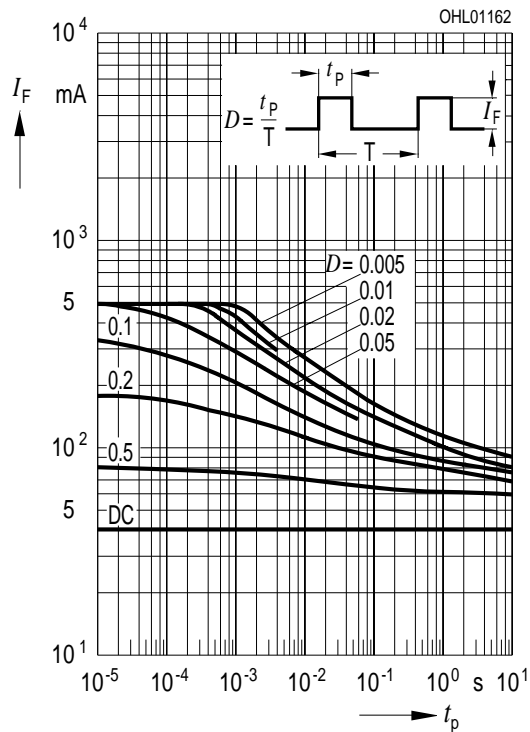

Zulässige Impulsbelastbarkeit $I_F = f(t_p)$
 Permissible Pulse Handling Capability
 Duty cycle $D = \text{parameter}$, $T_A = 25\text{ °C}$
 LP

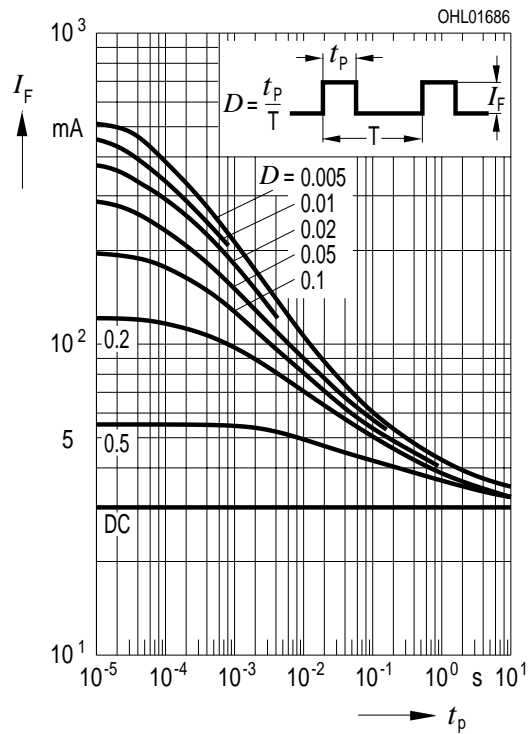

Maßzeichnung
Package Outlines

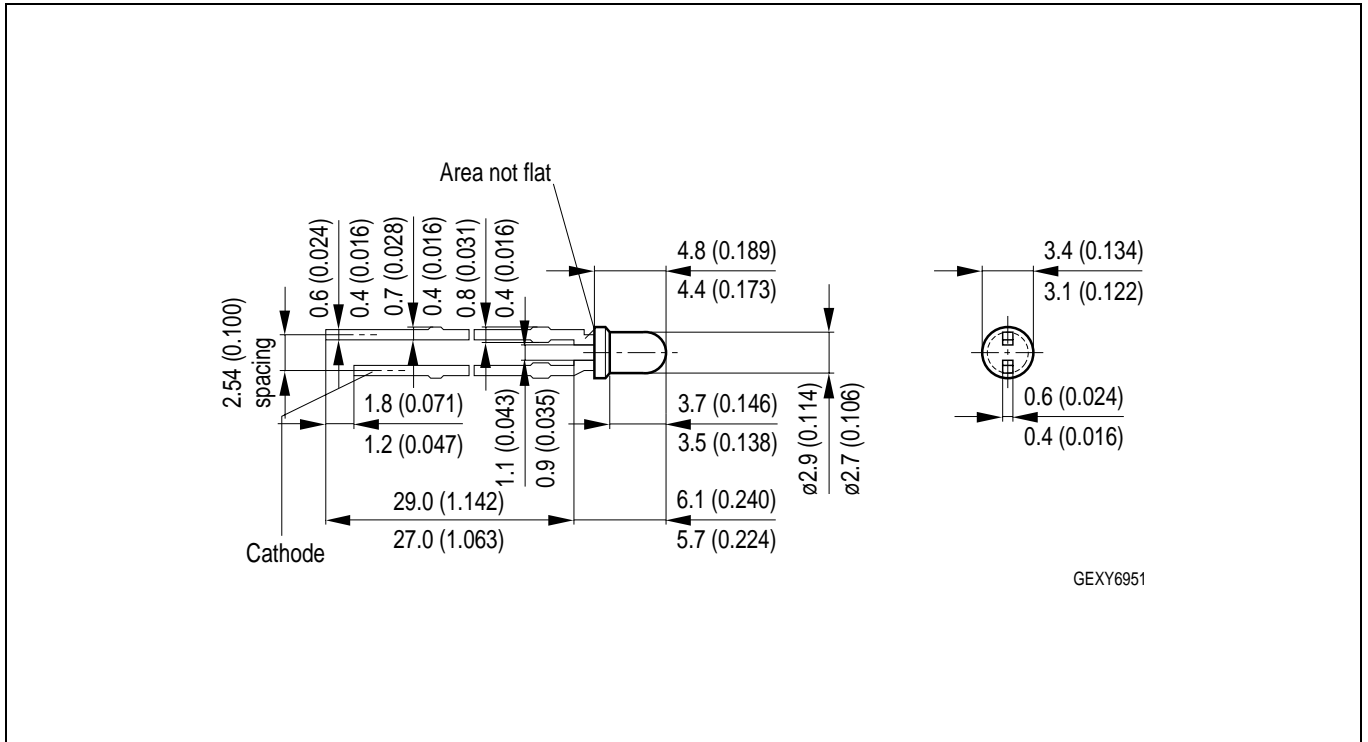

Maße werden wie folgt angegeben: mm (inch) / Dimensions are specified as follows: mm (inch).

Kathodenkennung: kürzerer Lötspieß
Cathode mark: short solder lead
Gewicht / Approx. weight: 0.15 g

Lötbedingungen
Soldering Conditions

Wellenlöten (TTW) (nach CECC 00802)
TTW Soldering (acc. to CECC 00802)

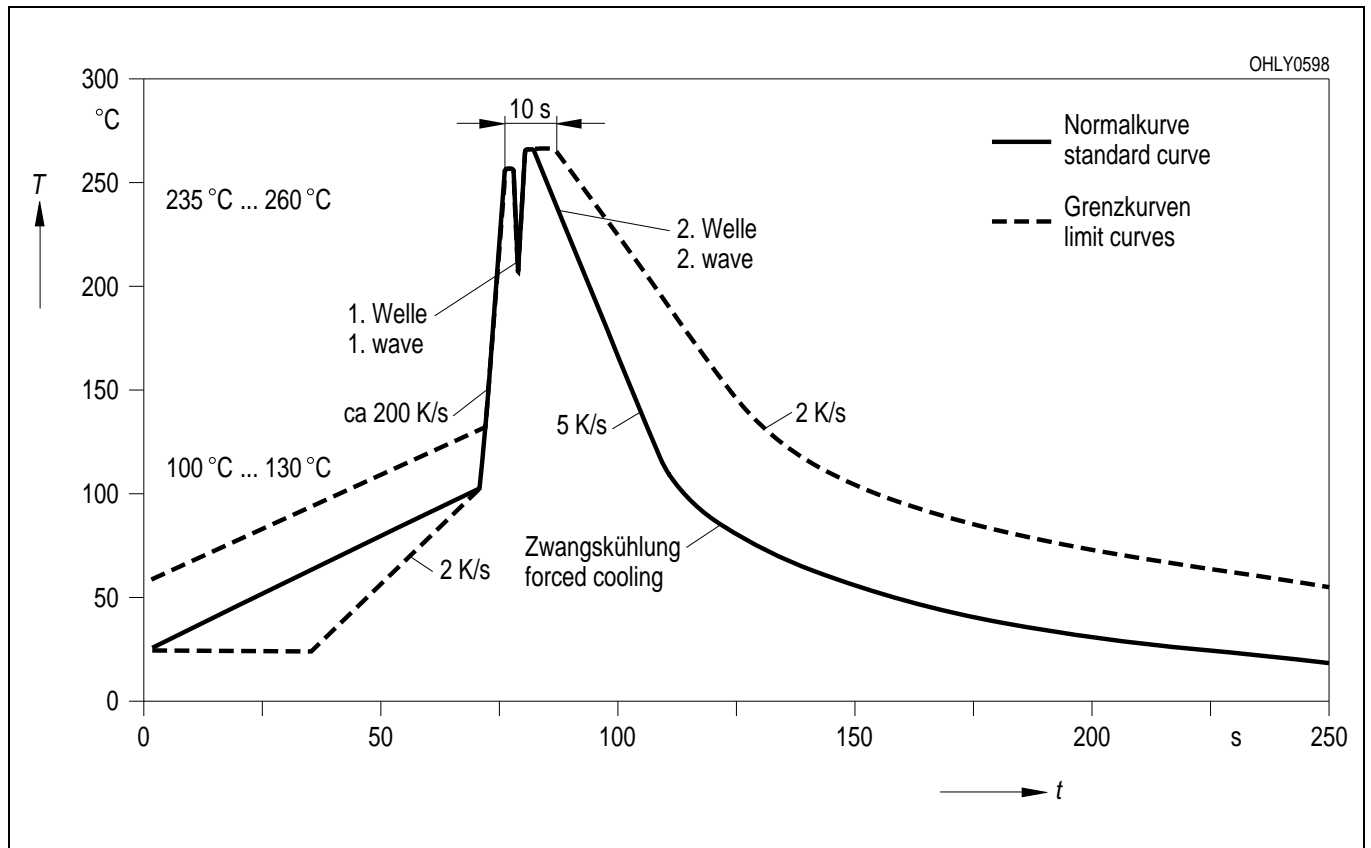

Empfohlenes Lötpaddesign Wellenlöten (TTW)
Recommended Solder Pad TTW Soldering

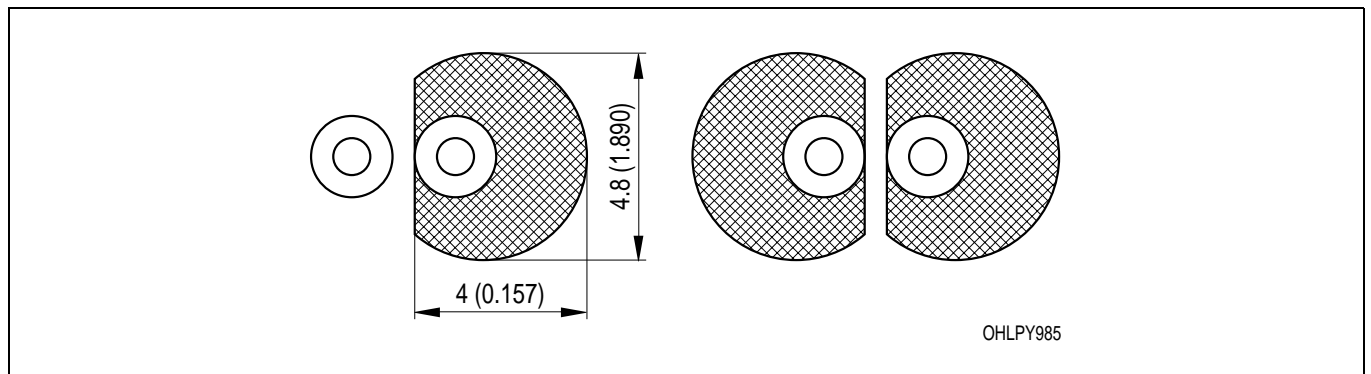

Maße werden wie folgt angegeben: mm (inch) / Dimensions are specified as follows: mm (inch).

Revision History: 2003-09-03		Date of change
Previous Version: 2002-09-18		
Page	Subjects (major changes since last revision)	
3	thermal resistance (footnote)	
4	dominant wavelength (orange)	
10	annotations	2002-07-23
5	luminous intensity groups	2002-07-30
3, 4	value (reverse voltage from 5 V to 12 V)	2002-09-18
2	low yield groups deleted	2003-09-03

Published by OSRAM Opto Semiconductors GmbH
Wernerwerkstrasse 2, D-93049 Regensburg

© All Rights Reserved.

Attention please!

The information describes the type of component and shall not be considered as assured characteristics. All typical data and graphs are basing on representative samples, but don't represent the production range. If requested, e.g. because of technical improvements, these typ. data will be changed without any further notice. Terms of delivery and rights to change design reserved. Due to technical requirements components may contain dangerous substances. For information on the types in question please contact our Sales Organization. If printed or downloaded, please find the latest version in the Internet.

Packing

Please use the recycling operators known to you. We can also help you – get in touch with your nearest sales office. By agreement we will take packing material back, if it is sorted. You must bear the costs of transport. For packing material that is returned to us unsorted or which we are not obliged to accept, we shall have to invoice you for any costs incurred.

Components used in life-support devices or systems must be expressly authorized for such purpose! Critical components ¹ may only be used in life-support devices or systems ² with the express written approval of OSRAM OS.

¹ A critical component is a component used in a life-support device or system whose failure can reasonably be expected to cause the failure of that life-support device or system, or to affect its safety or the effectiveness of that device or system.

² Life support devices or systems are intended (a) to be implanted in the human body, or (b) to support and/or maintain and sustain human life. If they fail, it is reasonable to assume that the health of the user may be endangered.