

## Multi TOPLED

### LSG T670, LSP T670, LSY T670, LOP T670, LYG T670



#### Besondere Merkmale

- **Gehäusetyp:** weißes P-LCC-4 Gehäuse
- **Besonderheit des Bauteils:** beide Leuchtdiodenchips getrennt ansteuerbar, hohe Signalwirkung durch Farbwechsel der LED möglich
- **Wellenlänge:** 628 nm (super-rot), 606 nm (orange), 590 nm (gelb), 570 nm (grün), 560 nm (pure green)
- **Abstrahlwinkel:** Lambertscher Strahler (120°)
- **Technologie:** GaAIP (super-rot, orange, gelb, grün), GaP (pure green)
- **optischer Wirkungsgrad:** 1,5 lm/W (super-rot, orange, gelb), 2,5 lm/W (grün), 0,6 lm/W (pure green)
- **Gruppierungsparameter:** Lichtstärke
- **Verarbeitungsmethode:** für alle SMT-Bestücktechniken geeignet
- **Lötmethode:** IR Reflow Löten und Wellenlöten (TTW)
- **Vorbehandlung:** nach JEDEC Level 2
- **Gurtung:** 8 mm Gurt mit 2000/Rolle, ø180 mm oder 8000/Rolle, ø330 mm

#### Anwendungen

- Informationsanzeigen im Innen- und Außenbereich
- optischer Indikator
- Hinterleuchtung (Schalter, Tasten, Displays, Werbebeleuchtung, Allgemeinbeleuchtung)
- Innenbeleuchtung im Automobilbereich (z. B. Instrumentenbeleuchtung)
- Markierungsbeleuchtung (z.B. Stufen, Fluchtwege, u.ä.)
- Einkopplung in Lichtleiter
- Laufschriftanzeigen
- Signal- und Symbolleuchten

#### Features

- **package:** white P-LCC-4 package
- **feature of the device:** both chips can be controlled separately, high signal efficiency possible by color change of the LED
- **wavelength:** 628 nm (super-red), 606 nm (orange), 590 nm (yellow), 570 nm (green), 560 nm (pure green)
- **viewing angle:** Lambertian Emitter (120°)
- **technology:** GaAIP (super-red, orange, yellow, green), GaP (pure green)
- **optical efficiency:** 1.5 lm/W (super-red, orange, yellow), 2.5 lm/W (green), 0.6 lm/W (pure green)
- **grouping parameter:** luminous intensity
- **assembly methods:** suitable for all SMT assembly methods
- **soldering methods:** IR reflow soldering and TTW soldering
- **preconditioning:** acc. to JEDEC Level 2
- **taping:** 8 mm tape with 2000/reel, ø180 mm or 8000/reel, ø330 mm

#### Applications

- indoor and outdoor displays
- optical indicators
- backlighting (switches, keys, displays, illuminated advertising, general lighting)
- interior automotive lighting (e.g. dashboard backlighting)
- marker lights (e.g. steps, exit ways, etc.)
- coupling into light guides
- light writing displays
- signal and symbol luminaire

# LSG T670, LSP T670, LSY T670, LOP T670, LYG T670

Typ	Emissions- farbe	Farbe der Lichtaustritts- fläche	Lichtstärke		Bestellnummer
Type	Color of Emission	Color of the Light Emitting Area	Luminous Intensity $I_F = 10 \text{ mA}$ $I_V \text{ (mcd)}$		Ordering Code
			color 1	color 2	
LSG T670 LSG T670-J+J LSG T670-J+K LSG T670-J+L LSG T670-K+J LSG T670-K+K LSG T670-K+L LSG T670-L+J LSG T670-L+K LSG T670-L+L	super-red / green	colorless clear	4.5 ... 18.0 4.5 ... 7.1 4.5 ... 7.1 4.5 ... 7.1 7.1 ... 11.2 7.1 ... 11.2 7.1 ... 11.2 11.2 ... 18.0 11.2 ... 18.0 11.2 ... 18.0	4.5 ... 18.0 4.5 ... 7.1 7.1 ... 11.2 11.2 ... 18.0 4.5 ... 7.1 7.1 ... 11.2 11.2 ... 18.0 4.5 ... 7.1 7.1 ... 11.2 11.2 ... 18.0	Q62703-Q4316
LSP T670 LSP T670-H+G LSP T670-H+H LSP T670-J+G LSP T670-J+H LSP T670-J+J LSP T670-K+G LSP T670-K+H LSP T670-K+J	super-red / pure green	colorless clear	2.8 ... 11.2 2.8 ... 4.5 2.8 ... 4.5 4.5 ... 7.1 4.5 ... 7.1 4.5 ... 7.1 7.1 ... 11.2 7.1 ... 11.2 7.1 ... 11.2	1.8 ... 7.1 1.8 ... 2.8 2.8 ... 4.5 1.8 ... 2.8 2.8 ... 4.5 4.5 ... 7.1 1.8 ... 2.8 2.8 ... 4.5 4.5 ... 7.1	Q62703-Q4318
LSY T670 LSY T670-J+J LSY T670-J+K LSY T670-J+L LSY T670-K+J LSY T670-K+K LSY T670-K+L LSY T670-L+J LSY T670-L+K LSY T670-L+L	super-red / yellow	colorless clear	4.5 ... 18.0 4.5 ... 7.1 4.5 ... 7.1 4.5 ... 7.1 7.1 ... 11.2 7.1 ... 11.2 7.1 ... 11.2 11.2 ... 18.0 11.2 ... 18.0 11.2 ... 18.0	4.5 ... 18.0 4.5 ... 7.1 7.1 ... 11.2 11.2 ... 18.0 4.5 ... 7.1 7.1 ... 11.2 11.2 ... 18.0 4.5 ... 7.1 7.1 ... 11.2 11.2 ... 18.0	Q62703-Q4317

# LSG T670, LSP T670, LSY T670, LOP T670, LYG T670

Typ	Emissions- farbe	Farbe der Lichtaustritts- fläche	Lichtstärke		Bestellnummer
Type	Color of Emission	Color of the Light Emitting Area	Luminous Intensity $I_F = 10 \text{ mA}$ $I_V \text{ (mcd)}$		Ordering Code
			color 1	color 2	
LOP T670	orange / green	colorless clear	4.5 ... 11.2	7.1 ... 28.0	Q62703-Q4319
LOP T670-J+K			4.5 ... 7.1	7.1 ... 11.2	
LOP T670-J+L			4.5 ... 7.1	11.2 ... 18.0	
LOP T670-J+M			4.5 ... 7.1	18.0 ... 28.0	
LOP T670-K+K			7.1 ... 11.2	7.1 ... 11.2	
LOP T670-K+L			7.1 ... 11.2	11.2 ... 18.0	
LOP T670-K+M			7.1 ... 11.2	18.0 ... 28.0	
LYG T670			yellow / green	colorless clear	
LYG T670-J+J	4.5 ... 7.1	4.5 ... 7.1			
LYG T670-J+K	4.5 ... 7.1	7.1 ... 11.2			
LYG T670-J+L	4.5 ... 7.1	11.2 ... 18.0			
LYG T670-K+J	7.1 ... 11.2	4.5 ... 7.1			
LYG T670-K+K	7.1 ... 11.2	7.1 ... 11.2			
LYG T670-K+L	7.1 ... 11.2	11.2 ... 18.0			
LYG T670-L+J	11.2 ... 18.0	4.5 ... 7.1			
LYG T670-L+K	11.2 ... 18.0	7.1 ... 11.2			
LYG T670-L+L	11.2 ... 18.0	11.2 ... 18.0			

Helligkeitswerte werden mit einer Stromeinprägedauer von 25 ms und einer Genauigkeit von  $\pm 11 \%$  ermittelt.  
Luminous intensity is tested at a current pulse duration of 25 ms and a tolerance of  $\pm 11 \%$ .

*Anm.: Die Standardlieferform von Serientypen beinhaltet eine Familiengruppe. Einzelne Gruppen sind nicht erhältlich.*

*In einer Verpackungseinheit / Gurt ist immer nur eine Gruppe pro Farbe enthalten.*

*Streuung der Lichtstärke in einer Verpackungseinheit  $I_{V \max} / I_{V \min} \leq 2.0$*

*Streuung der Lichtstärke in einer LED  $I_{V \max} / I_{V \min} \leq 3.0$  (LSG T670, LSY T670),  
 $\leq 4.0$  (LSP T670, LOP T670)*

*Note: The standard shipping format for serial types includes a family group. Individual groups are not available.*

*No packing unit / tape ever contains more than one luminous intensity group per color.*

*Luminous intensity ratio in one packaging unit  $I_{V \max} / I_{V \min} \leq 2.0$*

*Luminous intensity ratio in one LED  $I_{V \max} / I_{V \min} \leq 3.0$  (LSG T670, LSY T670),  
 $\leq 4.0$  (LSP T670, LOP T670)*

# LSG T670, LSP T670, LSY T670, LOP T670, LYG T670

## Grenzwerte Maximum Ratings

Bezeichnung Parameter	Symbol Symbol	Wert Value		Einheit Unit
		LS, LO, LY, LG	LP	
Betriebstemperatur Operating temperature range	$T_{op}$	- 40 ... + 100		°C
Lagertemperatur Storage temperature range	$T_{stg}$	- 40 ... + 100		°C
Sperrschichttemperatur Junction temperature	$T_j$	+ 100		°C
Durchlassstrom Forward current	$I_F$	30		mA
Stoßstrom Surge current $t \leq 10 \mu s, D = 0.005$	$I_{FM}$	0.5		A
Sperrspannung Reverse voltage	$V_R$	5		V
Leistungsaufnahme Power consumption	$P_{tot}$	95	90	mW
Wärmewiderstand Thermal resistance				
Sperrschicht / Umgebung Junction / air	1 chip on $R_{th JA}$	480		K/W
	2 chips on $R_{th JA}$	650		K/W
Sperrschicht / Löt看 Junction / solder point	1 chip on $R_{th JS}$	260		K/W
	2 chips on $R_{th JS}$	430		K/W
Montage auf PC-Board FR 4 (Padgröße $\geq 16 \text{ mm}^2$ ) mounted on PC board FR 4 (pad size $\geq 16 \text{ mm}^2$ )				

# LSG T670, LSP T670, LSY T670, LOP T670, LYG T670

Bezeichnung Parameter	Symbol Symbol	Wert Value					Einheit Unit
		LS	LO	LY	LG	LP	
Wellenlänge des emittierten Lichtes (typ.) Wavelength at peak emission $I_F = 10 \text{ mA}$	$\lambda_{\text{peak}}$	635	610	586	572	557	nm
Dominantwellenlänge <sup>1)</sup> (typ.) Dominant wavelength <sup>1)</sup> $I_F = 10 \text{ mA}$	$\lambda_{\text{dom}}$	628 $\pm 6$	606 $\pm 6$	590 $\pm 6$	570 $\pm 6$	560 $\pm 6$	nm
Spektrale Bandbreite bei 50 % $I_{\text{rel max}}$ (typ.) Spectral bandwidth at 50 % $I_{\text{rel max}}$ $I_F = 10 \text{ mA}$	$\Delta\lambda$	45	40	45	25	22	nm
Abstrahlwinkel bei 50 % $I_V$ (Vollwinkel) (typ.) Viewing angle at 50 % $I_V$	$2\phi$	120	120	120	120	120	Grad deg.
Durchlassspannung <sup>2)</sup> (typ.) Forward voltage <sup>2)</sup> (max.) $I_F = 10 \text{ mA}$	$V_F$ $V_F$	2.0 2.5	2.0 2.5	2.0 2.5	2.0 2.5	2.0 2.5	V V
Sperrstrom (typ.) Reverse current (max.) $V_R = 5 \text{ V}$	$I_R$ $I_R$	0.01 10	0.01 10	0.01 10	0.01 10	0.01 10	$\mu\text{A}$ $\mu\text{A}$
Temperaturkoeffizient von $\lambda_{\text{peak}}$ (typ.) Temperature coefficient of $\lambda_{\text{peak}}$ $I_F = 10 \text{ mA}; -10^\circ\text{C} \leq T \leq 100^\circ\text{C}$	$TC_{\lambda_{\text{peak}}}$	0.11	0.12	0.10	0.11	0.11	nm/K
Temperaturkoeffizient von $\lambda_{\text{dom}}$ (typ.) Temperature coefficient of $\lambda_{\text{dom}}$ $I_F = 10 \text{ mA}; -10^\circ\text{C} \leq T \leq 100^\circ\text{C}$	$TC_{\lambda_{\text{dom}}}$	0.07	0.07	0.07	0.07	0.05	nm/K
Temperaturkoeffizient von $V_F$ (typ.) Temperature coefficient of $V_F$ $I_F = 10 \text{ mA}; -10^\circ\text{C} \leq T \leq 100^\circ\text{C}$	$TC_V$	-1.9	-1.9	-1.9	-1.4	-2.1	mV/K
Optischer Wirkungsgrad (typ.) Optical efficiency $I_F = 10 \text{ mA}$	$\eta_{\text{opt}}$	1.5	1.5	1.5	2.5	0.6	lm/W

<sup>1)</sup> Wellenlängen werden mit einer Stromeinprägedauer von 25 ms und einer Genauigkeit von  $\pm 1 \text{ nm}$  ermittelt.  
Wavelengths are tested at a current pulse duration of 25 ms and a tolerance of  $\pm 1 \text{ nm}$ .

<sup>2)</sup> Spannungswerte werden mit einer Stromeinprägedauer von 1 ms und einer Genauigkeit von  $\pm 0.1 \text{ V}$  ermittelt.  
Voltages are tested at a current pulse duration of 1 ms and a tolerance of  $\pm 0.1 \text{ V}$ .

Relative spektrale Emission  $I_{rel} = f(\lambda)$ ,  $T_A = 25\text{ °C}$ ,  $I_F = 10\text{ mA}$

**Relative Spectral Emission**

$V(\lambda)$  = spektrale Augenempfindlichkeit

Standard eye response curve

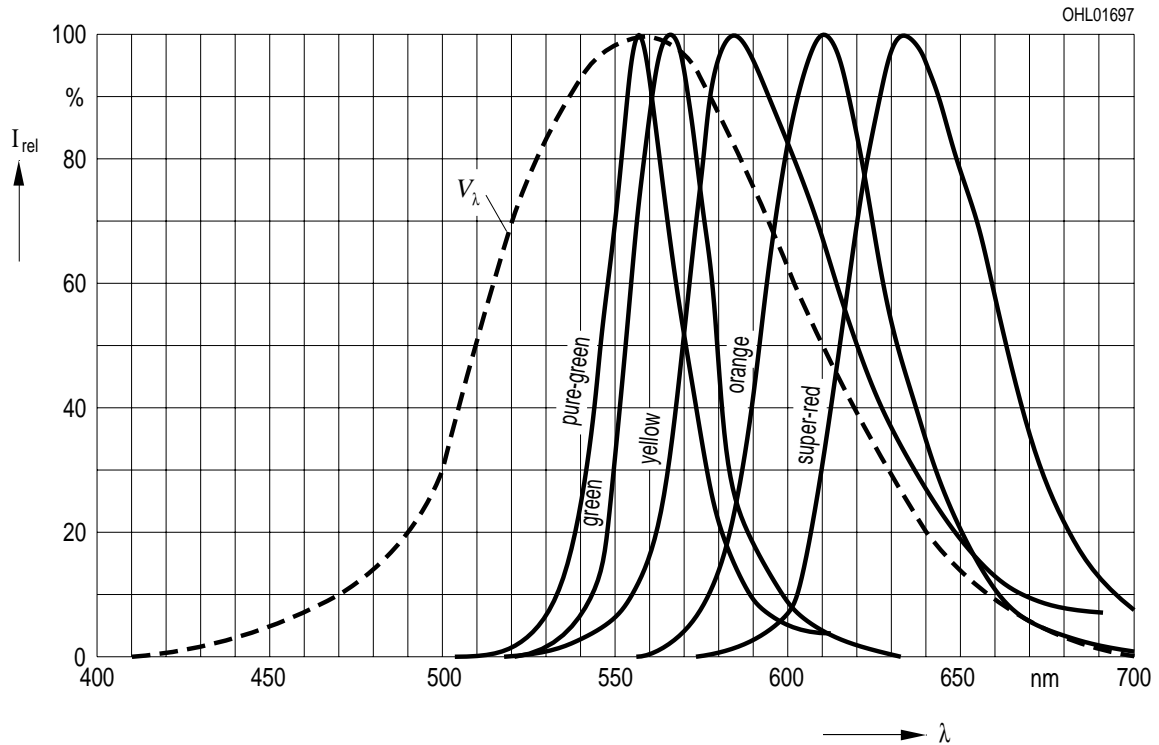

Abstrahlcharakteristik  $I_{rel} = f(\varphi)$

**Radiation Characteristic**

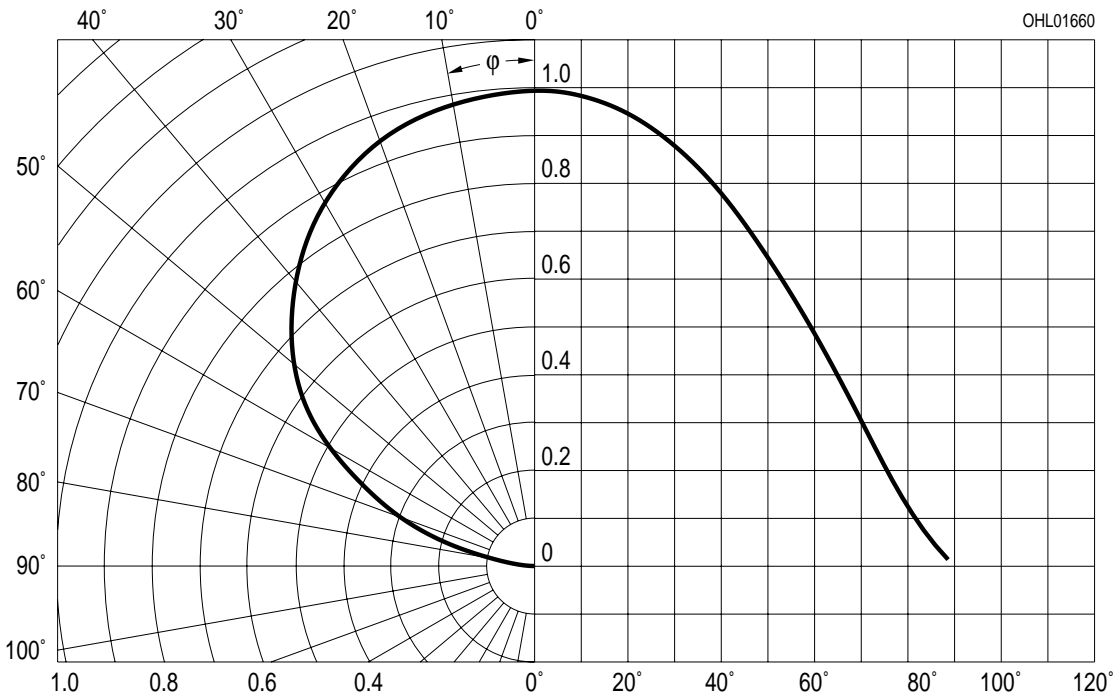

**Durchlassstrom  $I_F = f(V_F)$**   
**Forward Current**

$T_A = 25\text{ °C}$

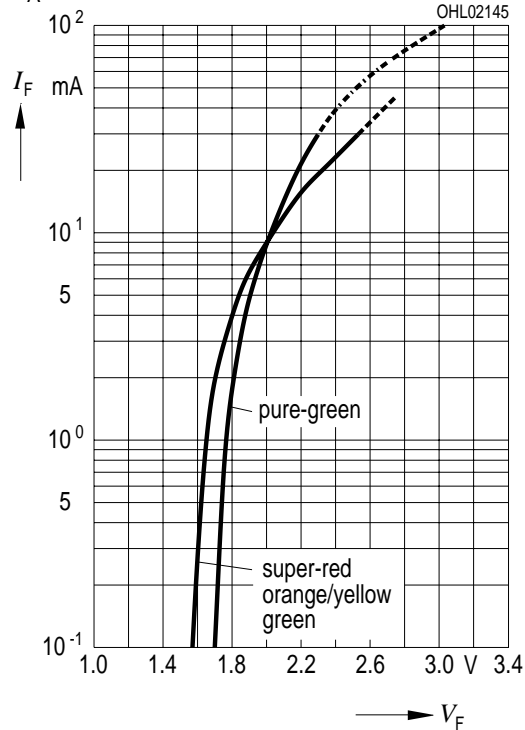

**Relative Lichtstärke  $I_V/I_{V(10\text{ mA})} = f(I_F)$**   
**Relative Luminous Intensity**

$T_A = 25\text{ °C}$

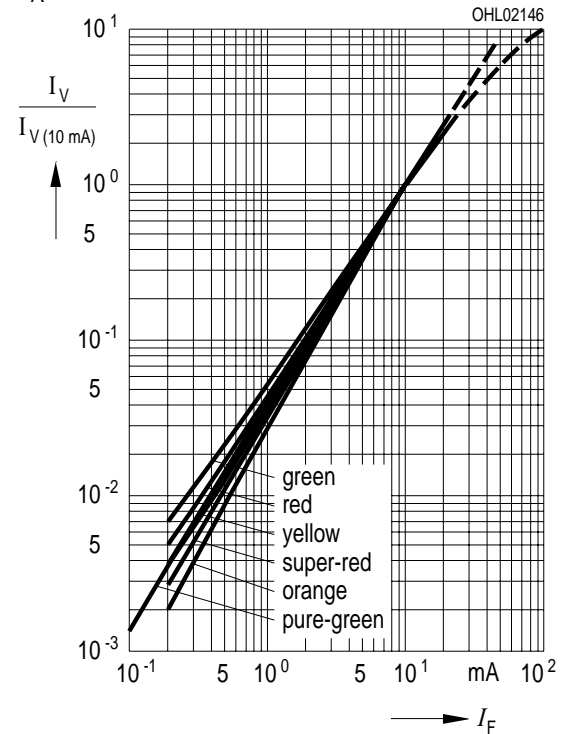

**Maximal zulässiger Durchlassstrom  $I_F = f(T)$**   
**Max. Permissible Forward Current**

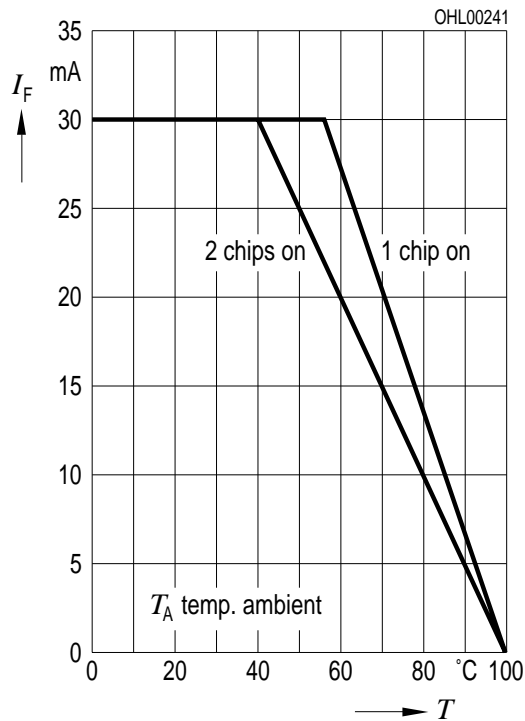

**Maximal zulässiger Durchlassstrom  $I_F = f(T)$**   
**Max. Permissible Forward Current**

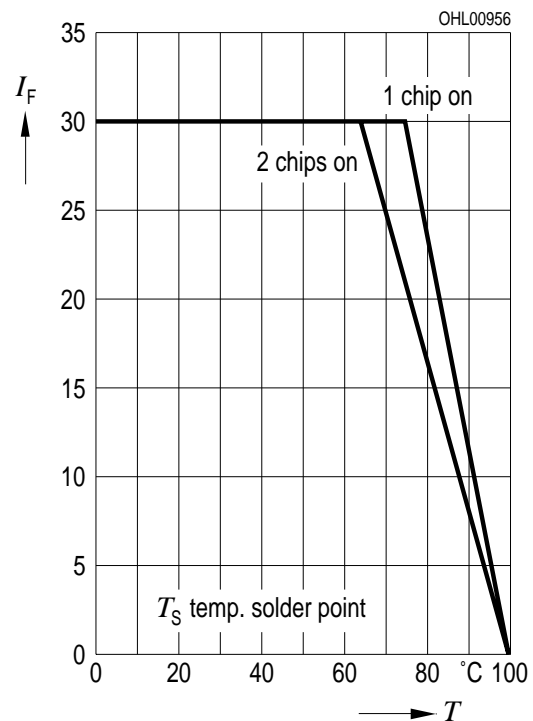

Relative Lichtstärke  $I_V/I_{V(25\text{ °C})} = f(T_A)$

Relative Luminous Intensity

$I_F = 10\text{ mA}$

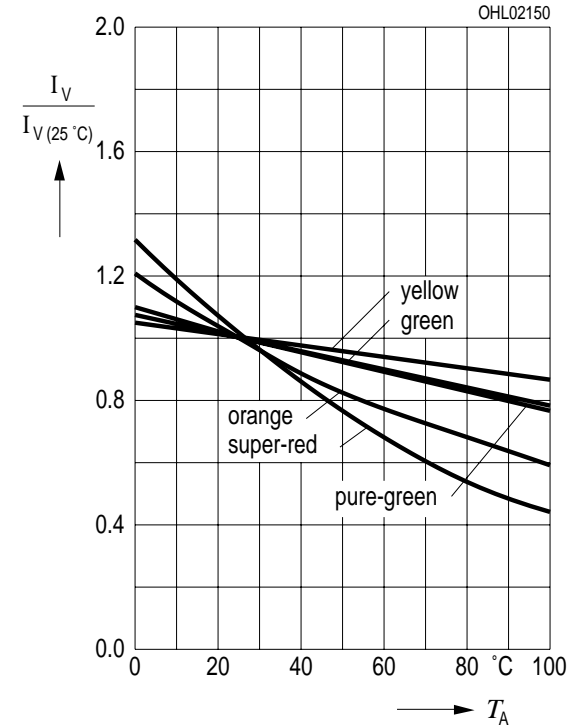

Zulässige Impulsbelastbarkeit  $I_F = f(t_p)$

Permissible Pulse Handling Capability

Duty cycle  $D = \text{parameter}$ ,  $T_A = 25\text{ °C}$

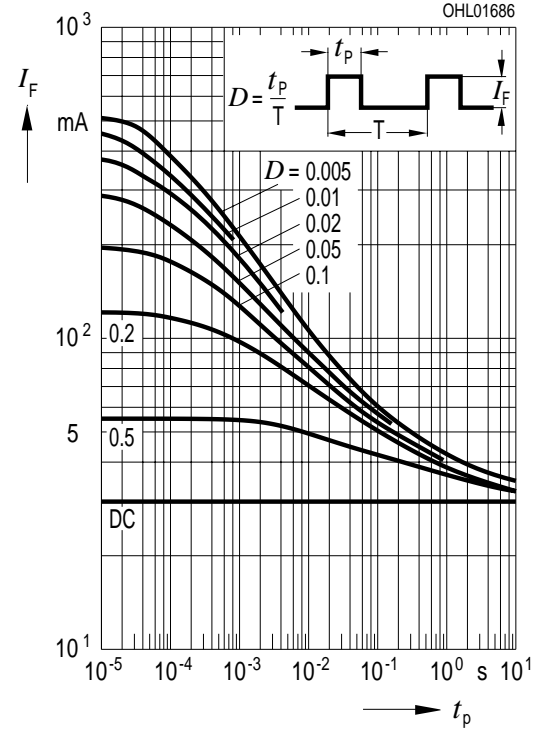



Maßzeichnung  
Package Outlines

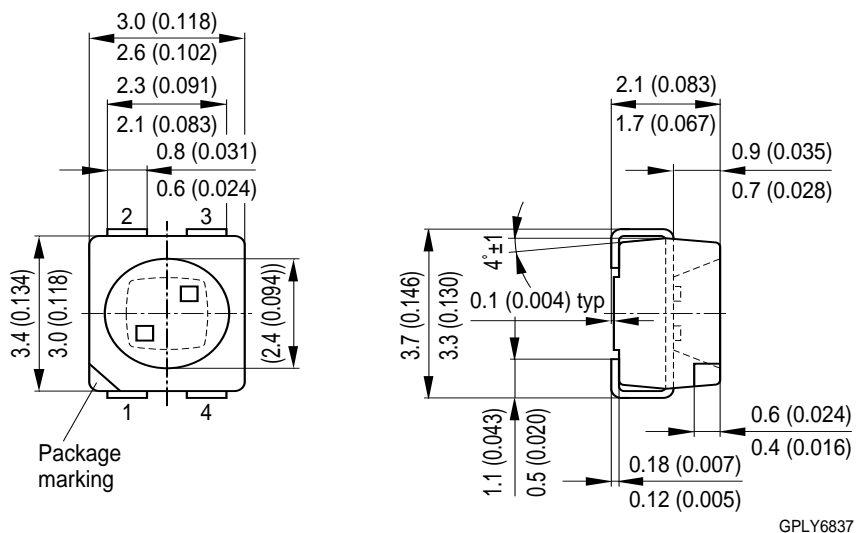

L	Color 1	Color 2	T670
LED	Emission color 1	Emission color 2	Package
	Cathode: pin 1	Cathode: pin 3	

Maße werden wie folgt angegeben: mm (inch) / Dimensions are specified as follows: mm (inch).

**Kathodenkennung:** abgeschrägte Ecke  
**Cathode mark:** bevelled edge  
**Gewicht / Approx. weight:** 34 mg

**Lötbedingungen** Vorbehandlung nach JEDEC Level 2  
**Soldering Conditions** Preconditioning acc. to JEDEC Level 2

**IR-Reflow Lötprofil** (nach IPC 9501)  
**IR Reflow Soldering Profile** (acc. to IPC 9501)

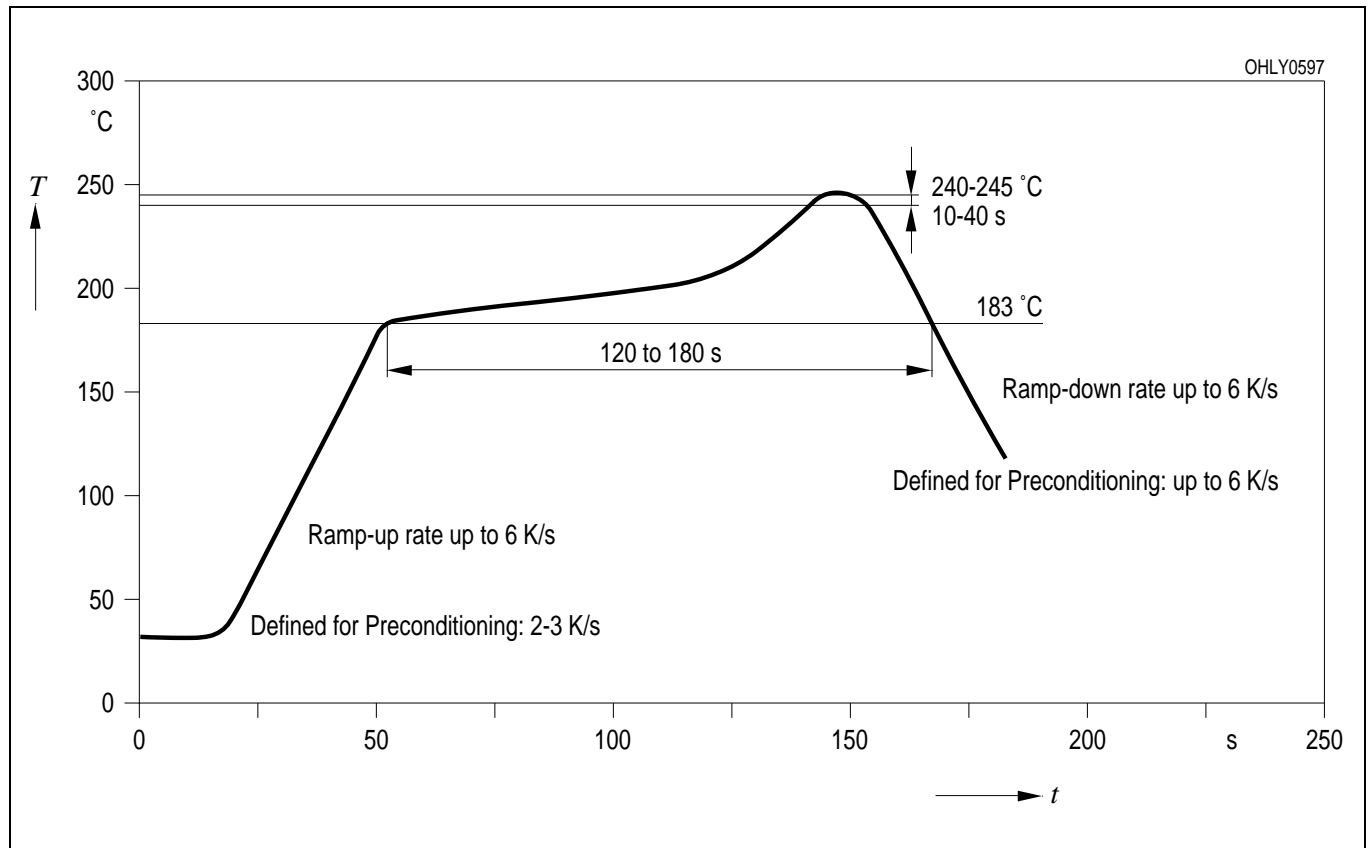

Wellenlöten (TTW) (nach CECC 00802)  
TTW Soldering (acc. to CECC 00802)

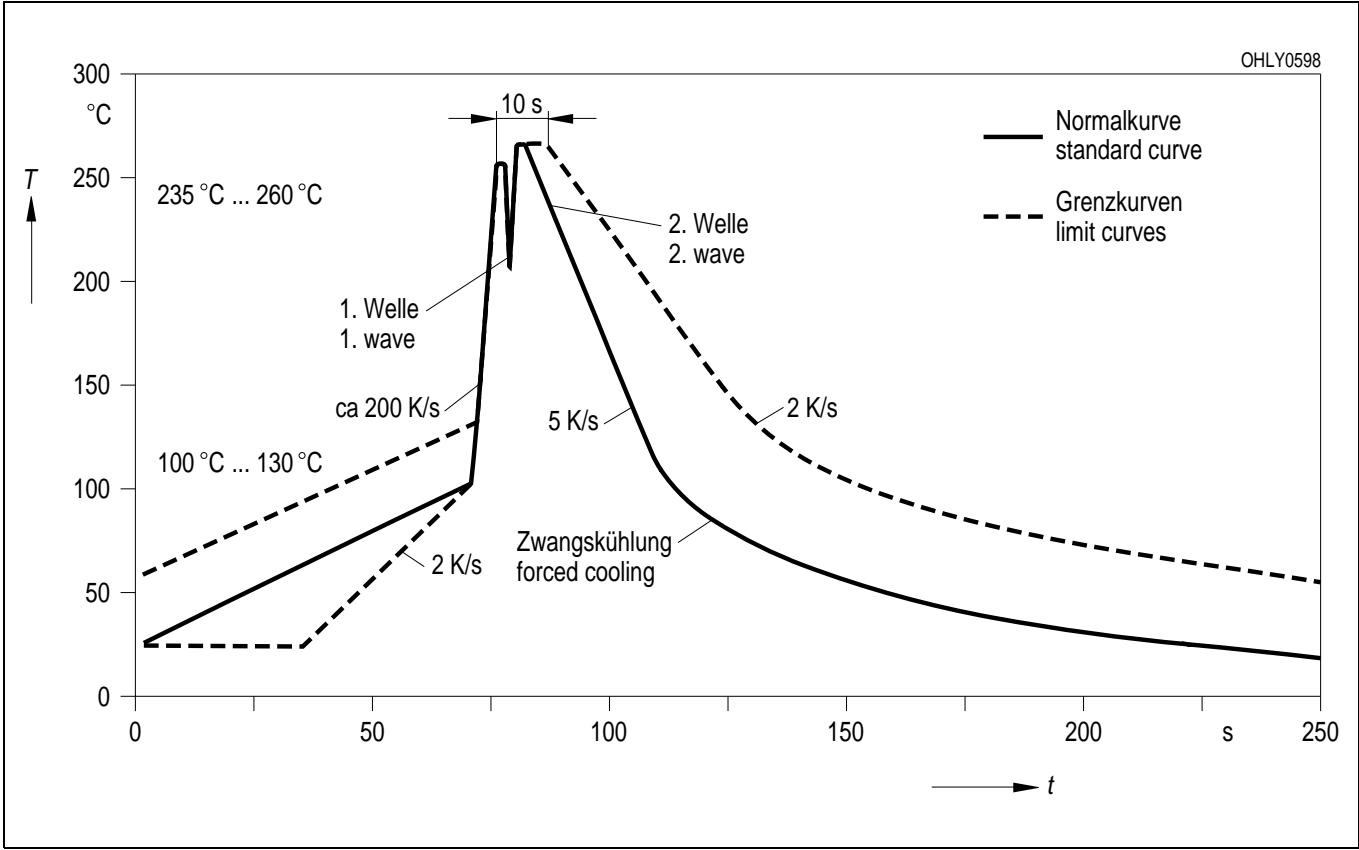

**Empfohlenes Lötpad Design** IR Reflow Lötten  
**Recommended Solder Pad** IR Reflow Soldering

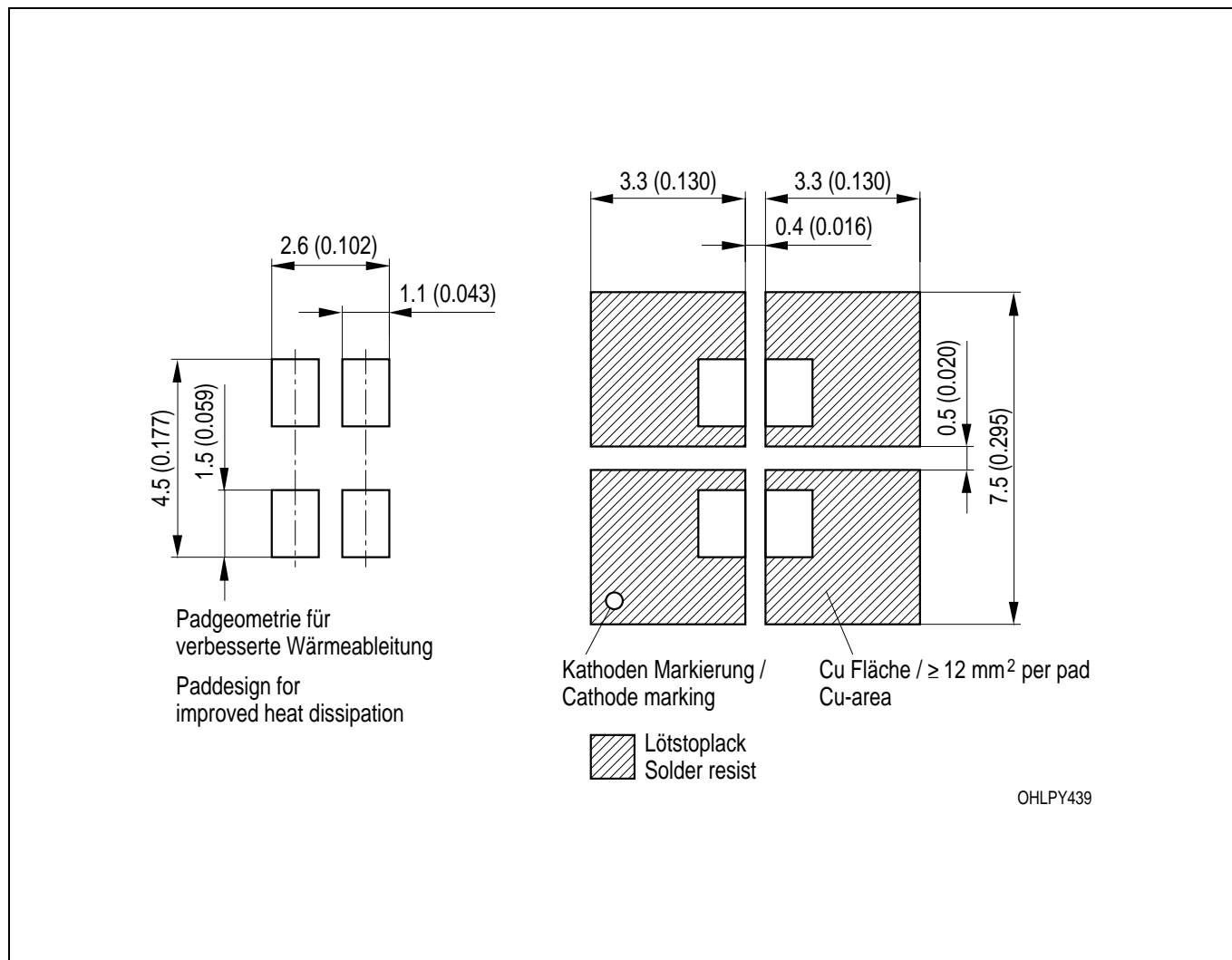

Maße werden wie folgt angegeben: mm (inch) / Dimensions are specified as follows: mm (inch).

**Empfohlenes Lötpad Design** Wellenlöten (TTW)  
**Recommended Solder Pad** TTW Soldering

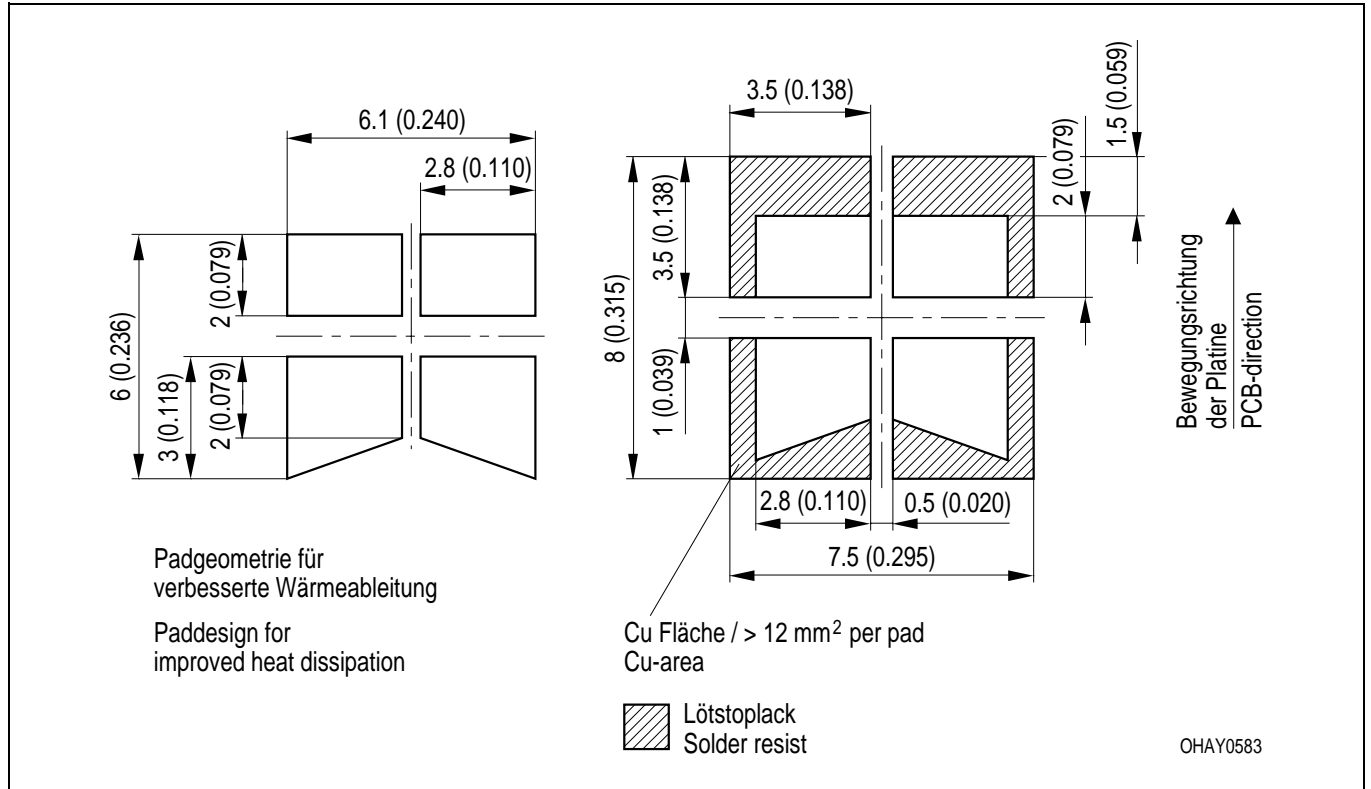

Maße werden wie folgt angegeben: mm (inch) / Dimensions are specified as follows: mm (inch).

**Gurtung / Polarität und Lage**

Verpackungseinheit 2000/Rolle, ø180 mm  
 oder 8000/Rolle, ø330 mm

**Method of Taping / Polarity and Orientation**

Packing unit 2000/reel, ø180 mm  
 or 8000/reel, ø330 mm

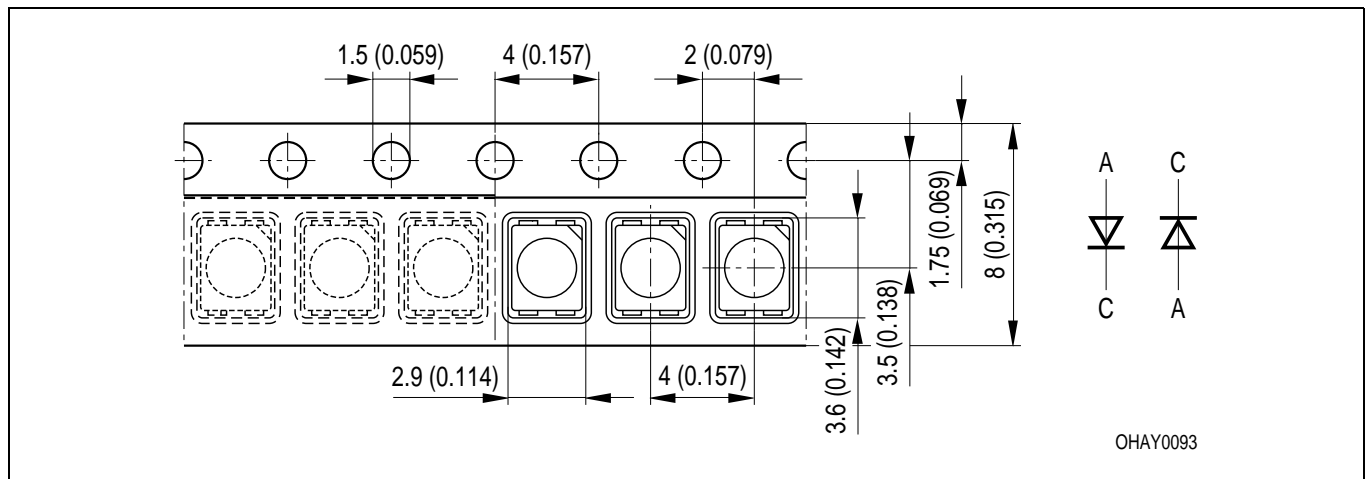

Maße werden wie folgt angegeben: mm (inch) / Dimensions are specified as follows: mm (inch).

---

**Revision History: 2001-07-23**

---

Previous Version: 2001-05-07

Page	Subjects (major changes since last revision)
3	note changed
5	dominant wavelength (yellow)
13	graphic (taping)

**Published by OSRAM Opto Semiconductors GmbH & Co. OHG**

**Wernerwerkstrasse 2, D-93049 Regensburg**

**© All Rights Reserved.**

**Attention please!**

The information describes the type of component and shall not be considered as assured characteristics. Terms of delivery and rights to change design reserved. Due to technical requirements components may contain dangerous substances. For information on the types in question please contact our Sales Organization.

If printed or downloaded, please find the latest version in the Internet.

**Packing**

Please use the recycling operators known to you. We can also help you – get in touch with your nearest sales office. By agreement we will take packing material back, if it is sorted. You must bear the costs of transport. For packing material that is returned to us unsorted or which we are not obliged to accept, we shall have to invoice you for any costs incurred.

**Components used in life-support devices or systems must be expressly authorized for such purpose!** Critical components <sup>1</sup> may only be used in life-support devices or systems <sup>2</sup> with the express written approval of OSRAM OS.

<sup>1</sup> A critical component is a component used in a life-support device or system whose failure can reasonably be expected to cause the failure of that life-support device or system, or to affect its safety or the effectiveness of that device or system.

<sup>2</sup> Life support devices or systems are intended (a) to be implanted in the human body, or (b) to support and/or maintain and sustain human life. If they fail, it is reasonable to assume that the health of the user may be endangered.