

# ARGUS® LED

## 3 mm (T1) LED, Non Diffused

LS K380, LO K380, LY K380, LG K380, LP K380



### Besondere Merkmale

- **Gehäusetypp:** eingefärbtes, klares 3 mm (T1) Gehäuse mit spezieller Linse
- **Besonderheit des Bauteils:** mit Einsatz eines äußeren Reflektors zur Hinterleuchtung von Leuchtfeldern und LCD-Anzeigen; Lötspieße mit Aufsetzebene
- **Wellenlänge:** 628 nm (super-rot), 606 nm (orange), 587 nm (gelb), 570 nm (grün), 560 nm (pure green)
- **Abstrahlwinkel:** angepasst an Einsatz mit äußerem Reflektor, siehe Diagramm
- **Technologie:** GaAlP (super-rot, orange, gelb, grün), GaP (pure green)
- **optischer Wirkungsgrad:** 1,5 lm/W (super-rot, orange, gelb), 2,5 lm/W (grün), 0,6 lm/W (pure green)
- **Gruppierungsparameter:** Lichtstrom
- **Lötmethode:** Wellenlöten (TTW)
- **Verpackung:** Schüttgut, gegurtet lieferbar

### Anwendungen

- Einsatz mit äußerem Reflektor
- optischer Indikator
- Hinterleuchtung (LCD, Schalter, Tasten, Displays)
- Innenbeleuchtung im Automobilbereich (z.B. Instrumentenbeleuchtung, u.ä.)
- Einkopplung in Lichtleiter

### Features

- **package:** colored, clear 3 mm (T1) package with specially shaped lens
- **feature of the device:** for backlighting and LCDs with use of a reflector; solder leads with stand-off
- **wavelength:** 628 nm (super-red), 606 nm (orange), 587 nm (yellow), 570 nm (green), 560 nm (pure green)
- **viewing angle:** matched to use with external reflector, see diagram
- **technology:** GaAlP (super-red, orange, yellow, green), GaP (pure green)
- **optical efficiency:** 1.5 lm/W (super-red, orange, yellow), 2.5 lm/W (green), 0.6 lm/W (pure green)
- **grouping parameter:** luminous flux
- **soldering methods:** TTW soldering
- **packing:** bulk, available taped on reel

### Applications

- use of reflector
- optical indicators
- backlighting (LCD, switches, keys, displays)
- interior automotive lighting (e.g. dashboard backlighting, etc.)
- coupling into light guides

## LS K380, LO K380, LY K380, LG K380, LP K380

Typ Type	Emissionsfarbe Color of Emission	Gehäusefarbe Color of Package	Lichtstrom Luminous Flux $I_F = 15 \text{ mA}$ $\Phi_V$ (mlm)	Bestellnummer Ordering Code
LS K380-LP LS K380-N LS K380-P LS K380-Q LS K380-NR	super-red	red clear	11.2 ... 71.0 28.0 ... 45.0 45.0 ... 71.0 71.0 ... 112.0 28.0 ... 180.0	Q62703-Q1768 Q62703-Q0760 Q62703-Q1003 Q62703-Q1004 Q62703-Q2223
LO K380-LP LO K380-N LO K380-P LO K380-Q LO K380-NR	orange	orange clear	11.2 ... 71.0 28.0 ... 45.0 45.0 ... 71.0 71.0 ... 112.0 28.0 ... 180.0	Q62703-Q1888 Q62703-Q2227 Q62703-Q2228 Q62703-Q2229 Q62703-Q2201
LY K380-LP LY K380-N LY K380-P LY K380-Q LY K380-NR	yellow	yellow clear	11.2 ... 71.0 28.0 ... 45.0 45.0 ... 71.0 71.0 ... 112.0 28.0 ... 180.0	Q62703-Q1769 Q62703-Q0575 Q62703-Q0576 Q62703-Q3844 Q62703-Q2224
LG K380-LP LG K380-N LG K380-P LG K380-Q LG K380-NR	green	green clear	11.2 ... 71.0 28.0 ... 45.0 45.0 ... 71.0 71.0 ... 112.0 28.0 ... 180.0	Q62703-Q1770 Q62703-Q0759 Q62703-Q1034 Q62703-Q3193 Q62703-Q2225
LP K380-KN LP K380-L LP K380-M LP K380-N LP K380-LP	pure green	colorless clear	7.1 ... 45.0 11.2 ... 18.0 18.0 ... 28.0 28.0 ... 45.0 11.2 ... 71.0	Q62703-Q2506 Q62703-Q3215 Q62703-Q2610 Q62703-Q2605 Q62703-Q3217

Helligkeitswerte werden mit einer Stromeinprägedauer von 25 ms und einer Genauigkeit von  $\pm 11 \%$  ermittelt.  
Luminous intensity is tested at a current pulse duration of 25 ms and a tolerance of  $\pm 11 \%$ .

*Anm.: Die Standardlieferform von Serientypen beinhaltet eine untere bzw. eine obere Familiengruppe oder mindestens zwei Einzelgruppen.*

*In einer Verpackungseinheit / Gurt ist immer nur eine Helligkeitsgruppe enthalten.*

*Die technologiebedingte Helligkeits-Streuung der heutigen LED-Herstellprozesse über einen längeren Fertigungszeitraum (Halbleitermaterial - Chipherstellung - Montageprozess) erlaubt keine Zusage einer einzelnen Helligkeitsgruppe. Daher müssen mindestens zwei Helligkeitsgruppen vorgesehen werden!*

*Note: The standard shipping format for serial types includes a lower or upper family group or at least two individual groups.*

*No packing unit / tape ever contains more than one luminous intensity group.*

*Luminosity variations caused by the technology used in current LED manufacturing processes over a protracted manufacturing period (semiconductor material - chip fabrication - assembly process) mean that it is not possible to assign LEDs to a single luminous intensity group. For this reason at least two luminous intensity groups must be provided!.*

**Grenzwerte**  
**Maximum Ratings**

Bezeichnung Parameter	Symbol Symbol	Wert Value		Einheit Unit
		LS, LO, LY, LG	LP	
Betriebstemperatur Operating temperature range	$T_{op}$	- 55 ... + 100		°C
Lagertemperatur Storage temperature range	$T_{stg}$	- 55 ... + 100		°C
Sperrschichttemperatur Junction temperature	$T_j$	+ 100		°C
Durchlassstrom Forward current	$I_F$	40	30	mA
Stoßstrom Surge current $t \leq 10 \mu s, D = 0.005$	$I_{FM}$	0.5		A
Sperrspannung Reverse voltage	$V_R$	5		V
Leistungsaufnahme Power consumption	$P_{tot}$	130	95	mW
Wärmewiderstand <sup>1)</sup> Thermal resistance Sperrschicht/Umgebung Junction/ambient	$R_{th JA}$	400		K/W
Sperrschicht/Löt看 Junction/solder point Montage auf PC-Board FR 4 (Padgröße $\geq 16 \text{ mm}^2$ ) mounted on PC board FR 4 (pad size $\geq 16 \text{ mm}^2$ ) Minimale Beinchenlänge Minimum lead length	$R_{th JS}$	180		K/W

<sup>1)</sup>  $R_{th}$  erhöht sich um 13 K/W pro mm Beinchenlänge.  
Each additional 1 mm of lead length increases  $R_{th}$  by 13 K/W.

Kennwerte ( $T_A = 25\text{ °C}$ )

Characteristics

Bezeichnung Parameter	Symbol Symbol	Wert Value					Einheit Unit
		LS	LO	LY	LG	LP	
Wellenlänge des emittierten Lichtes (typ.) Wavelength at peak emission $I_F = 15\text{ mA}$	$\lambda_{\text{peak}}$	635	610	586	572	557	nm
Dominantwellenlänge <sup>1)</sup> (typ.) Dominant wavelength $I_F = 15\text{ mA}$	$\lambda_{\text{dom}}$	628	606	587	570	560	nm
Spektrale Bandbreite bei 50 % $\Phi_{\text{rel max}}$ (typ.) Spectral bandwidth at 50 % $\Phi_{\text{rel max}}$ $I_F = 15\text{ mA}$	$\Delta\lambda$	45	40	45	25	22	nm
Durchlassspannung <sup>2)</sup> (typ.) Forward voltage (max.) $I_F = 15\text{ mA}$	$V_F$ $V_F$	2.1 2.5	2.1 2.5	2.1 2.5	2.1 2.5	2.1 2.5	V V
Sperrstrom (typ.) Reverse current (max.) $V_R = 5\text{ V}$	$I_R$ $I_R$	0.01 10	0.01 10	0.01 10	0.01 10	0.01 10	$\mu\text{A}$ $\mu\text{A}$
Temperaturkoeffizient von $\lambda_{\text{peak}}$ (typ.) Temperature coefficient of $\lambda_{\text{peak}}$ $I_F = 15\text{ mA}; -10\text{ °C} \leq T \leq 100\text{ °C}$	$TC_{\lambda_{\text{peak}}}$	0.11	0.12	0.10	0.11	0.11	nm/K
Temperaturkoeffizient von $\lambda_{\text{dom}}$ (typ.) Temperature coefficient of $\lambda_{\text{dom}}$ $I_F = 15\text{ mA}; -10\text{ °C} \leq T \leq 100\text{ °C}$	$TC_{\lambda_{\text{dom}}}$	0.07	0.07	0.07	0.07	0.05	nm/K
Temperaturkoeffizient von $V_F$ (typ.) Temperature coefficient of $V_F$ $I_F = 15\text{ mA}; -10\text{ °C} \leq T \leq 100\text{ °C}$	$TC_V$	-1.9	-1.9	-1.9	-1.4	-2.1	mV/K
Optischer Wirkungsgrad (typ.) Optical efficiency $I_F = 15\text{ mA}$	$\eta_{\text{opt}}$	1.5	1.5	1.5	2.5	0.6	lm/W

<sup>1)</sup> Wellenlängen werden mit einer Stromeinprägungsdauer von 25 ms und einer Genauigkeit von  $\pm 1\text{ nm}$  ermittelt.  
Wavelengths are tested at a current pulse duration of 25 ms and a tolerance of  $\pm 1\text{ nm}$ .

<sup>2)</sup> Spannungswerte werden mit einer Stromeinprägungsdauer von 1 ms und einer Genauigkeit von  $\pm 0,1\text{ V}$  ermittelt.  
Voltages are tested at a current pulse duration of 1 ms and a tolerance of  $\pm 0.1\text{ V}$ .

Relative spektrale Emission  $I_{rel} = f(\lambda)$ ,  $T_A = 25\text{ °C}$ ,  $I_F = 15\text{ mA}$

**Relative Spectral Emission**

$V(\lambda)$  = spektrale Augenempfindlichkeit

Standard eye response curve

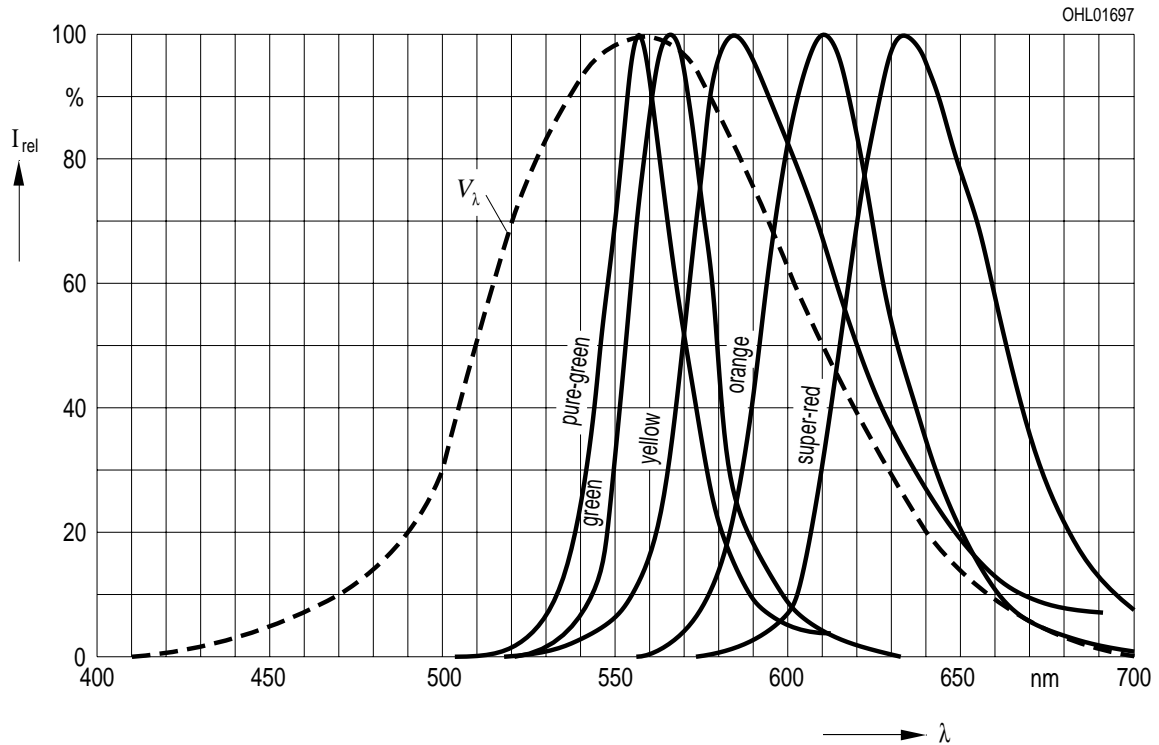

Abstrahlcharakteristik  $I_{rel} = f(\varphi)$

**Radiation Characteristic**

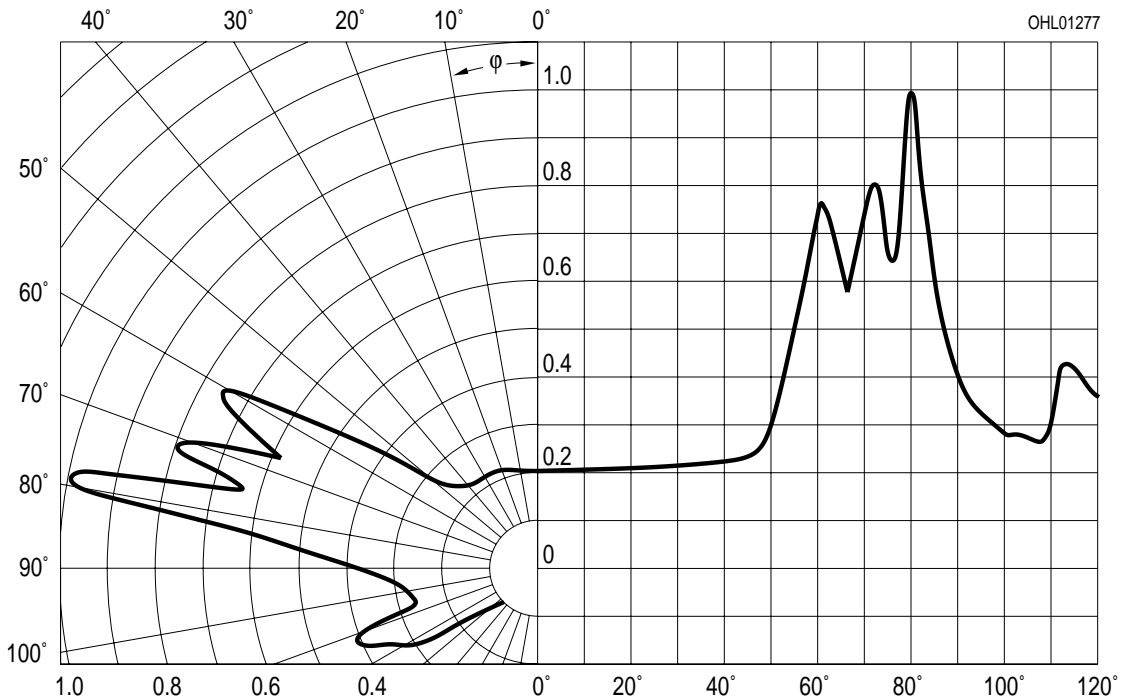

**Durchlassstrom  $I_F = f(V_F)$**   
**Forward Current**

$T_A = 25\text{ }^\circ\text{C}$

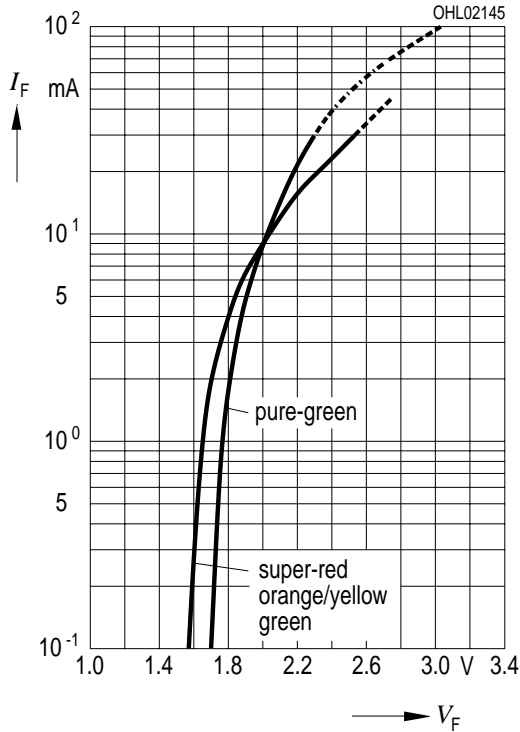

**Relativer Lichtstrom  $\Phi_V/\Phi_{V(15\text{ mA})} = f(I_F)$**   
**Relative Luminous Flux**

$T_A = 25\text{ }^\circ\text{C}$

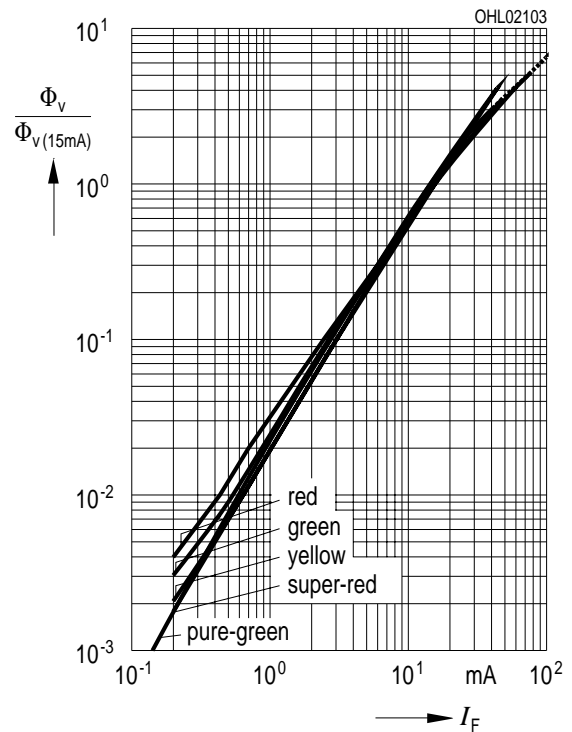

**Maximal zulässiger Durchlassstrom  $I_F = f(T)$**   
**Max. Permissible Forward Current**  
**LS, LO, LY, LG**

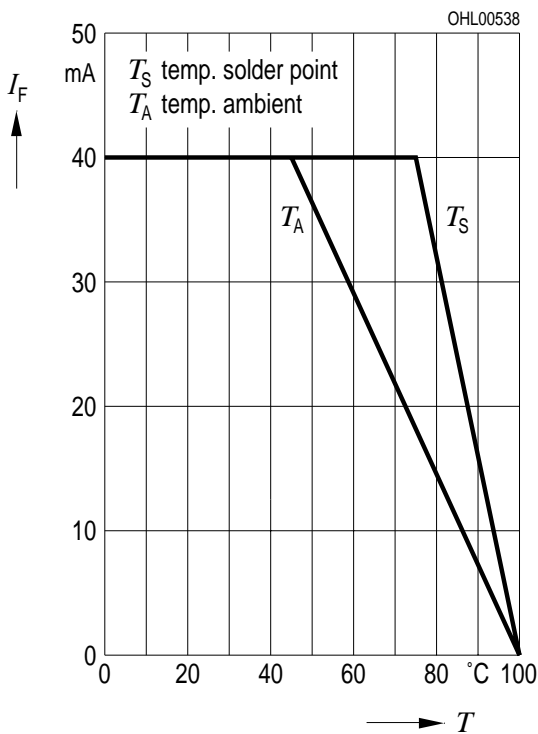

**Maximal zulässiger Durchlassstrom  $I_F = f(T)$**   
**Max. Permissible Forward Current**  
**LP**

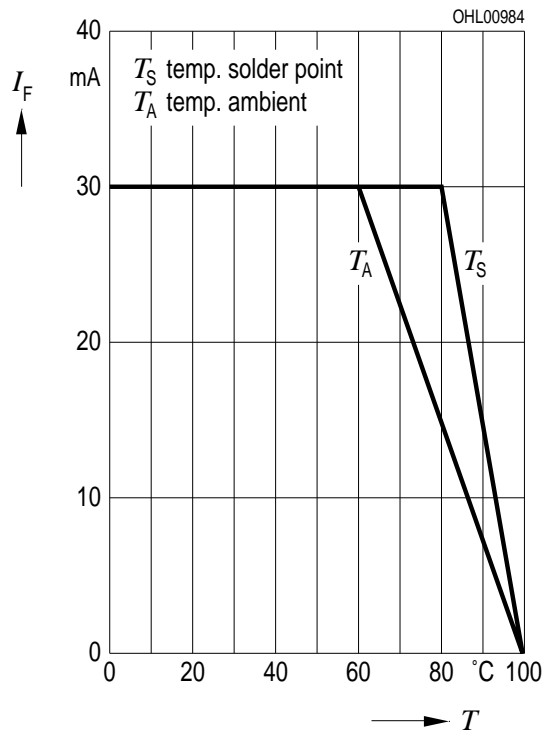

Relativer Lichtstrom  $\Phi_V / \Phi_{V(25^\circ\text{C})} = f(T_A)$   
 Relative Luminous Flux  
 $I_F = 15 \text{ mA}$

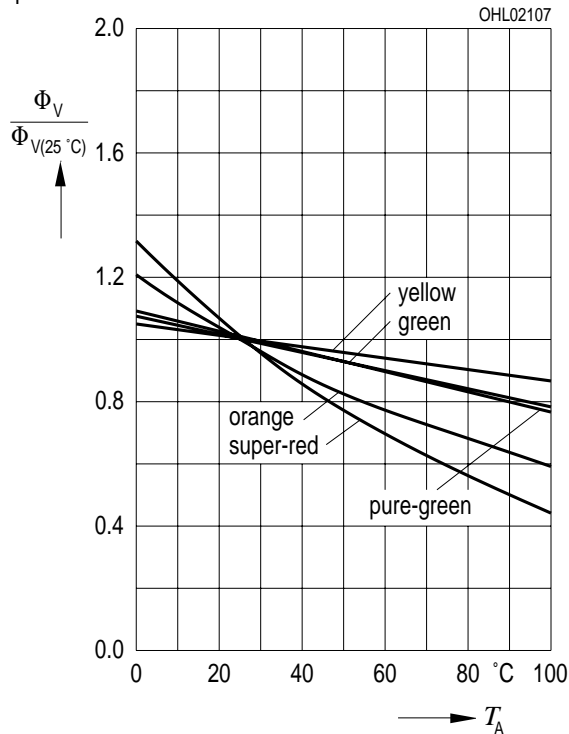

Zulässige Impulsbelastbarkeit  $I_F = f(t_p)$   
 Permissible Pulse Handling Capability  
 Duty cycle  $D =$  parameter,  $T_A = 25^\circ\text{C}$   
 LS, LO, LY, LG

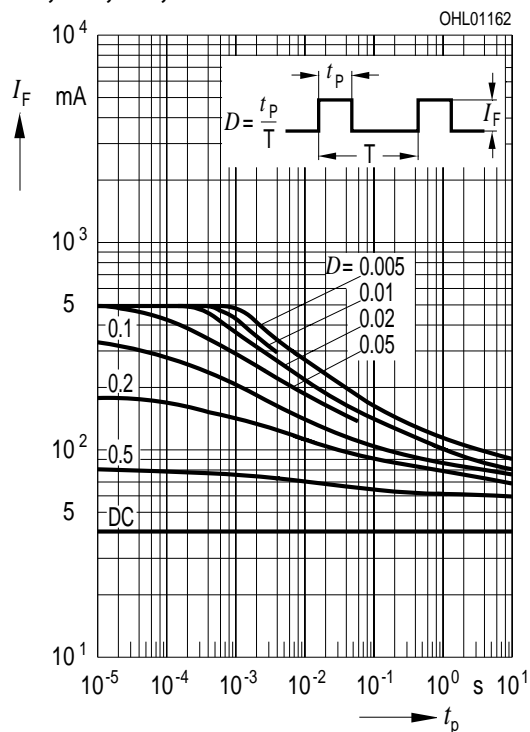

Zulässige Impulsbelastbarkeit  $I_F = f(t_p)$   
 Permissible Pulse Handling Capability  
 Duty cycle  $D =$  parameter,  $T_A = 25^\circ\text{C}$   
 LP

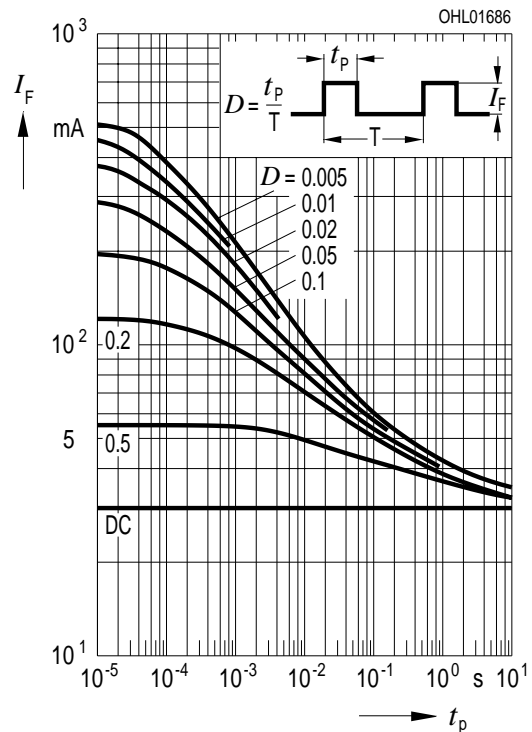

**Maßzeichnung**  
**Package Outlines**

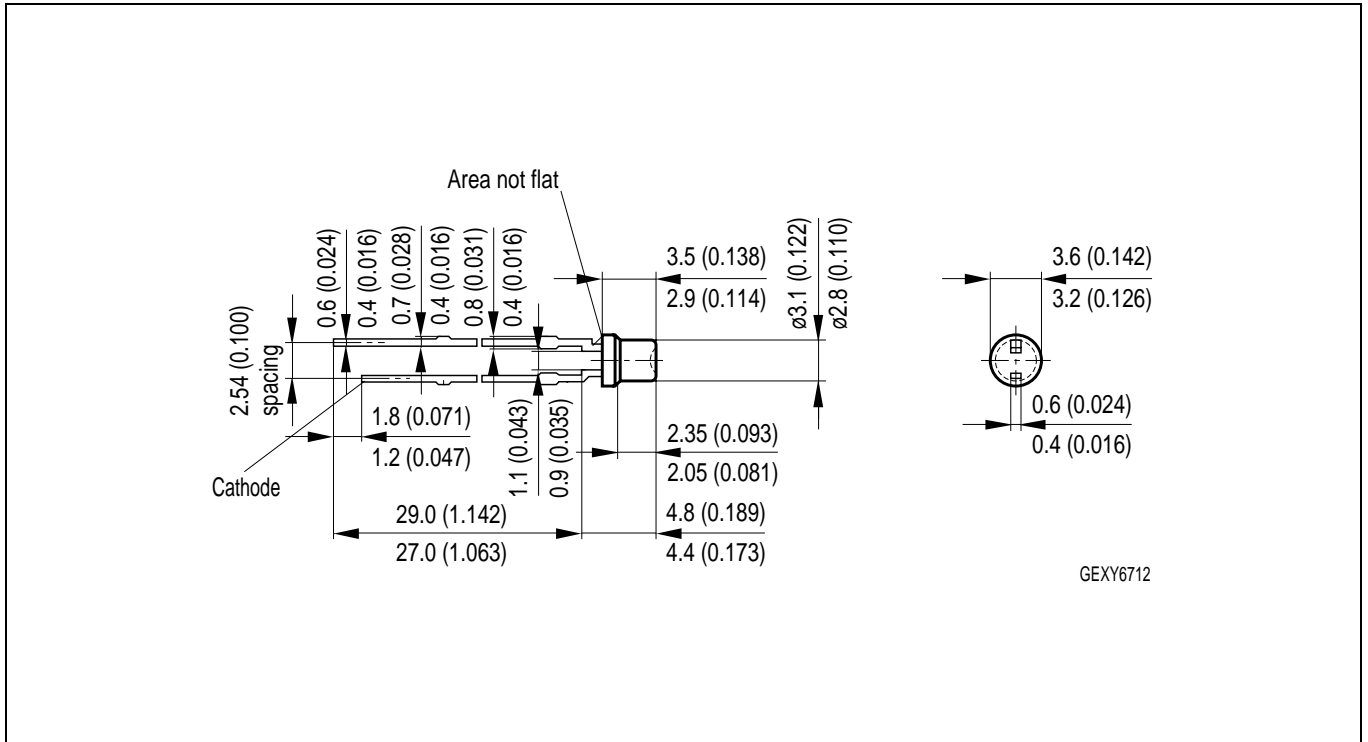

Maße werden wie folgt angegeben: mm (inch) / Dimensions are specified as follows: mm (inch).

**Kathodenkennung:** kürzerer Lötspieß  
**Cathode mark:** short solder lead  
**Gewicht / Approx. weight:** 160 mg



**Lötbedingungen**  
**Soldering Conditions**

**Wellenlöten (TTW)** (nach CECC 00802)  
**TTW Soldering** (acc. to CECC 00802)

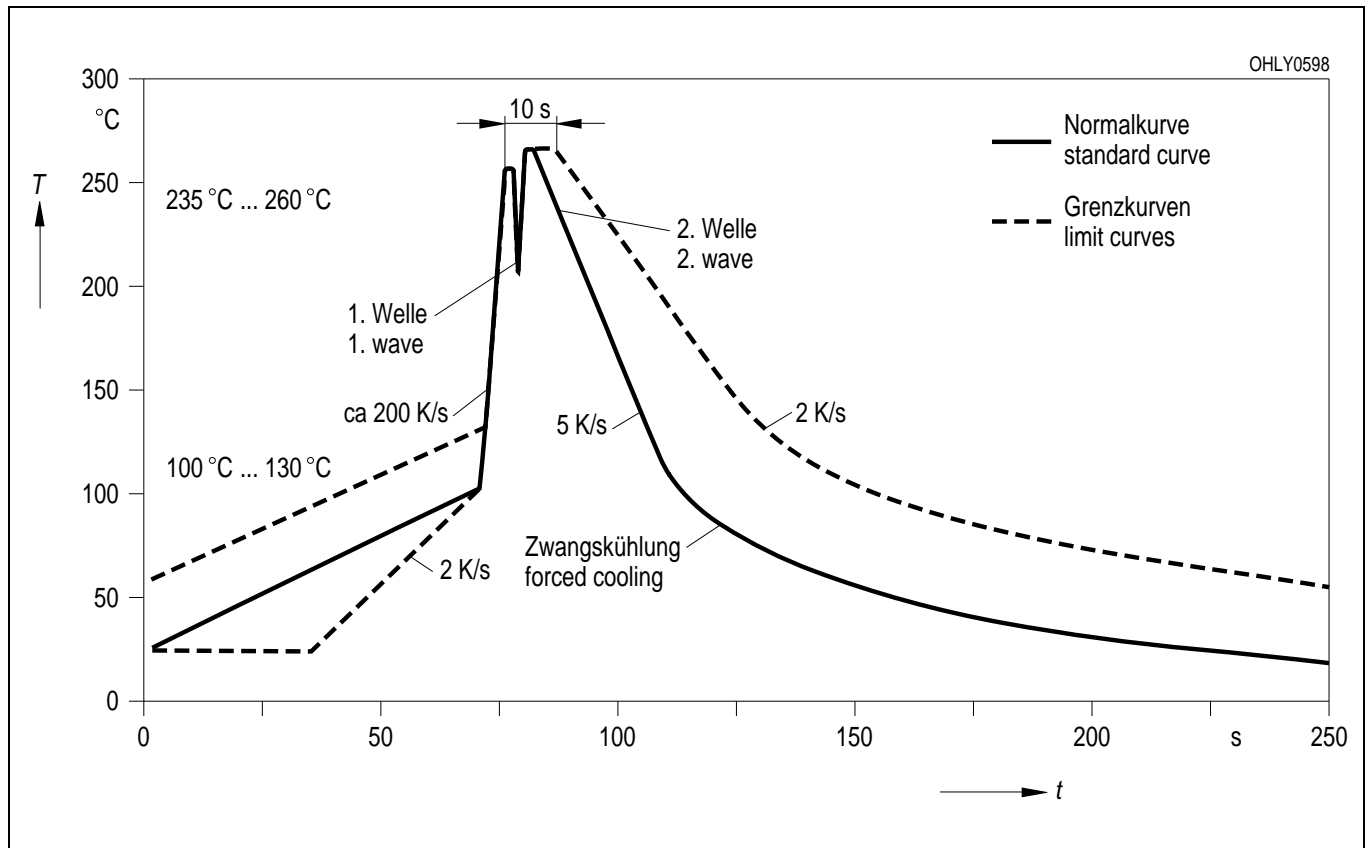

**Empfohlenes Lötpaddesign** Wellenlöten (TTW)  
**Recommended Solder Pad** TTW Soldering

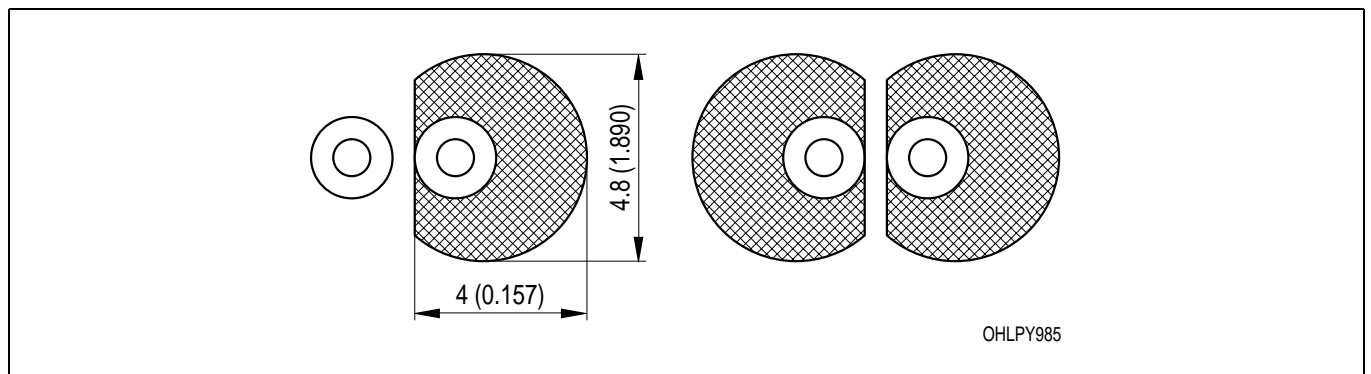

Maße werden wie folgt angegeben: mm (inch) / Dimensions are specified as follows: mm (inch).

---

**Revision History: 2002-03-15**

---

Previous Version: 2001-02-14

---

Page	Subjects (major changes since last revision)
3	thermal resistance (footnote)
4	value (wavelength orange)

**Published by OSRAM Opto Semiconductors GmbH & Co. OHG**

**Wernerwerkstrasse 2, D-93049 Regensburg**

**© All Rights Reserved.**

**Attention please!**

The information describes the type of component and shall not be considered as assured characteristics. Terms of delivery and rights to change design reserved. Due to technical requirements components may contain dangerous substances. For information on the types in question please contact our Sales Organization. If printed or downloaded, please find the latest version in the Internet.

**Packing**

Please use the recycling operators known to you. We can also help you – get in touch with your nearest sales office. By agreement we will take packing material back, if it is sorted. You must bear the costs of transport. For packing material that is returned to us unsorted or which we are not obliged to accept, we shall have to invoice you for any costs incurred.

**Components used in life-support devices or systems must be expressly authorized for such purpose!** Critical components <sup>1</sup> may only be used in life-support devices or systems <sup>2</sup> with the express written approval of OSRAM OS.

<sup>1</sup> A critical component is a component used in a life-support device or system whose failure can reasonably be expected to cause the failure of that life-support device or system, or to affect its safety or the effectiveness of that device or system.

<sup>2</sup> Life support devices or systems are intended (a) to be implanted in the human body, or (b) to support and/or maintain and sustain human life. If they fail, it is reasonable to assume that the health of the user may be endangered.

This datasheet has been download from:

[www.datasheetcatalog.com](http://www.datasheetcatalog.com)

Datasheets for electronics components.