

Engwinklige LED in MIDLED-Gehäuse
Narrow beam LED in MIDLED package
Lead (Pb) Free Product - RoHS Compliant

SFH 4650
SFH 4655

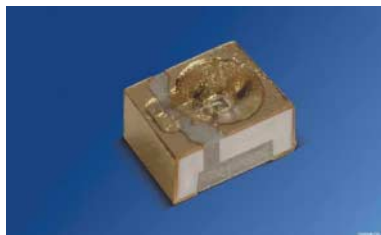

SFH 4650



SFH 4655

Vorläufige Daten / Preliminary Data

Wesentliche Merkmale

- Infrarot LED mit hoher Ausgangsleistung (40 mW)
- Emissionswellenlänge typ. 850 nm
- Enger Abstrahlwinkel ($\pm 20^\circ$)
- geringe Bauhöhe
- Als Toplooker und Sidelooker einsetzbar
- SFH 4650: Gurtung als Toplooker
SFH 4655: Gurtung als Sidelooker

Features

- High Power (40 mW) Infrared LED
- Peak wavelength typ. 850 nm
- Narrow halfangle ($\pm 20^\circ$)
- low profile component
- Usable as top-looking and side-looking device
- SFH 4650: Taping as Toplooker
SFH 4655: Taping as Sidelooker

Anwendungen

- Infrarotbeleuchtung für CMOS Kameras
- IR-Datenübertragung
- Sensorik in der Automobiltechnik
- Fernsteuerung

Applications

- Infrared Illumination for CMOS cameras
- IR Data Transmission
- Automotive sensors
- Remote controls

Sicherheitshinweise

Je nach Betriebsart emittieren diese Bauteile hochkonzentrierte, nicht sichtbare Infrarot-Strahlung, die gefährlich für das menschliche Auge sein kann. Produkte, die diese Bauteile enthalten, müssen gemäß den Sicherheitsrichtlinien der IEC-Norm 60825-1 behandelt werden.

Safety Advices

Depending on the mode of operation, these devices emit highly concentrated non visible infrared light which can be hazardous to the human eye. Products which incorporate these devices have to follow the safety precautions given in IEC 60825-1 "Safety of laser products".

Typ Type	Bestellnummer Ordering Code	Strahlstärkegruppierung ($I_F = 100 \text{ mA}, t_p = 20 \text{ ms}$) Radiant Intensity Grouping I_e (mW/sr)
SFH 4650	Q65110A1572	>16 (typ. 40)
SFH 4655	Q65110A1569	>16 (typ. 40)



ATTENTION - Observe Precautions For Handling - Electrostatic Sensitive Device

Grenzwerte ($T_A = 25\text{ °C}$)

Maximum Ratings

Bezeichnung Parameter	Symbol Symbol	Wert Value	Einheit Unit
Betriebs- und Lagertemperatur Operating and storage temperature range	$T_{op}; T_{stg}$	- 40 ... + 100	°C
Sperrspannung Reverse voltage	V_R	5	V
Durchlassstrom Forward current	I_F	100	mA
Stoßstrom, $\tau = 10\ \mu\text{s}$, $D = 0$ Surge current	I_{FSM}	1	A
Verlustleistung Power dissipation	P_{tot}	180	mW
Wärmewiderstand Sperrschicht ¹⁾ Thermal resistance junction	R_{thJA}	340	K/W
Wärmewiderstand Sperrschicht ²⁾ Thermal resistance junction	R_{thJS}	180	K/W

¹⁾Umgebung bei Montage auf FR4 Platine, Padgröße je 16 mm²
ambient mounted on PC-board (FR4), pads size 16 mm² each

²⁾Lötstelle bei Montage auf Metall-Block
soldering point, mounted on metal block

Kennwerte ($T_A = 25\text{ °C}$)

Characteristics

Bezeichnung Parameter	Symbol Symbol	Wert Value	Einheit Unit
Wellenlänge der Strahlung Wavelength at peak emission $I_F = 100\text{ mA}$	λ_{peak}	850	nm
Spektrale Bandbreite bei 50% von I_{max} Spectral bandwidth at 50% of I_{max} $I_F = 100\text{ mA}$	$\Delta\lambda$	35	nm
Abstrahlwinkel Half angle	φ	± 20	Grad deg.

Kennwerte ($T_A = 25\text{ °C}$)

Characteristics (cont'd)

Bezeichnung Parameter	Symbol Symbol	Wert Value	Einheit Unit
Aktive Chipfläche Active chip area	A	0.09	mm ²
Abmessungen der aktiven Chipfläche Dimension of the active chip area	$L \times B$ $L \times W$	0.3×0.3	mm
Schaltzeiten, I_e von 10% auf 90% und von 90% auf 10%, bei $I_F = 100\text{ mA}$, $R_L = 50\ \Omega$ Switching times, I_e from 10% to 90% and from 90% to 10%, $I_F = 100\text{ mA}$, $R_L = 50\ \Omega$	t_r , t_f	12	ns
Durchlassspannung Forward voltage $I_F = 100\text{ mA}$, $t_p = 20\text{ ms}$ $I_F = 1\text{ A}$, $t_p = 100\ \mu\text{s}$	V_F V_F	1.5 (< 1.8) 2.4 (< 3.0)	V V
Sperrstrom Reverse current $V_R = 5\text{ V}$	I_R	not designed for reverse operation	μA
Gesamtstrahlungsfluss Total radiant flux $I_F = 100\text{ mA}$, $t_p = 20\text{ ms}$	Φ_e	40	mW
Temperaturkoeffizient von I_e bzw. Φ_e , $I_F = 100\text{ mA}$ Temperature coefficient of I_e or Φ_e , $I_F = 100\text{ mA}$	TC_I	- 0.5	%/K
Temperaturkoeffizient von V_F , $I_F = 100\text{ mA}$ Temperature coefficient of V_F , $I_F = 100\text{ mA}$	TC_V	- 0.7	mV/K
Temperaturkoeffizient von λ , $I_F = 100\text{ mA}$ Temperature coefficient of λ , $I_F = 100\text{ mA}$	TC_λ	+ 0.2	nm/K

Strahlstärke I_e in Achsrichtung¹⁾gemessen bei einem Raumwinkel $\Omega = 0.01$ sr**Radiant Intensity I_e in Axial Direction**at a solid angle of $\Omega = 0.01$ sr

Bezeichnung Parameter	Symbol	Werte Values			Einheit Unit
		-S	-T	-U	
Strahlstärke Radiant intensity $I_F = 100$ mA, $t_p = 20$ ms	$I_{e \text{ min}}$ $I_{e \text{ max}}$	16 32	25 50	40 80	mW/sr mW/sr
Strahlstärke Radiant intensity $I_F = 1$ A, $t_p = 100$ μ s	$I_{e \text{ typ}}$	200	250	300	mW/sr

¹⁾ Nur eine Gruppe in einer Verpackungseinheit (Streuung kleiner 2:1)

¹⁾ Only one group in one packing unit, (variation lower 2:1)

Relative Spectral Emission

$I_{rel} = f(\lambda)$

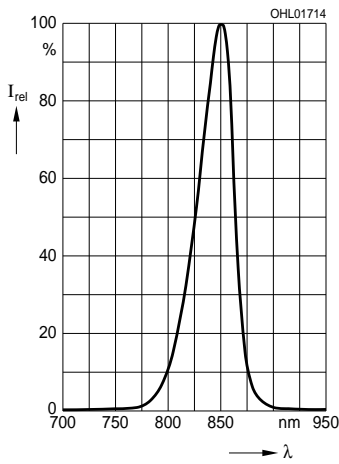

Radiant Intensity $\frac{I_e}{I_e(100\text{ mA})} = f(I_F)$

Single pulse, $t_p = 20\ \mu\text{s}$

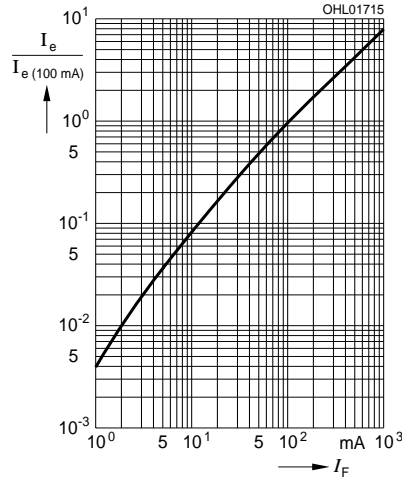

Forward Current $I_F = f(V_F)$

Single pulse, $t_p = 20\ \mu\text{s}$

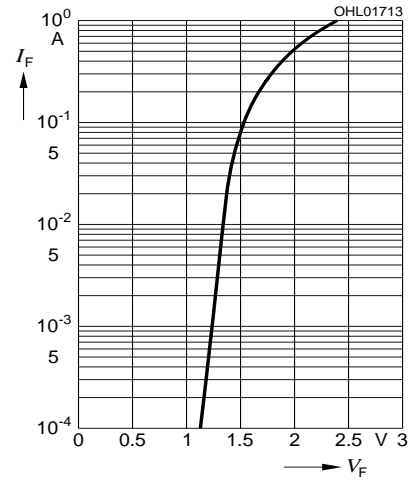

Max. Permissible Forward Current

$I_F = f(T_A); R_{thJA} = 450\ \text{K/W}^{1)}$

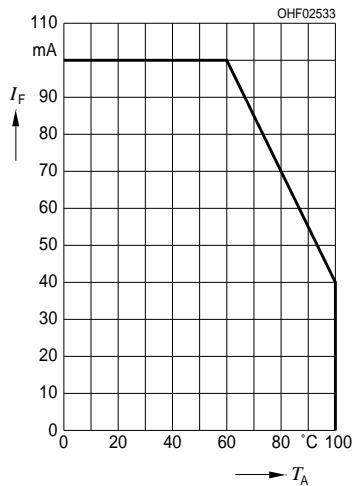

Permissible Pulse Handling Capability

$I_F = f(t_p), T_A = 25\ \text{°C}$
duty cycle $D = \text{parameter}$

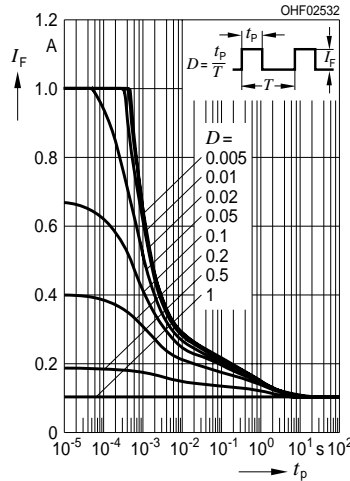

Radiation Characteristics $I_{rel} = f(\varphi)$

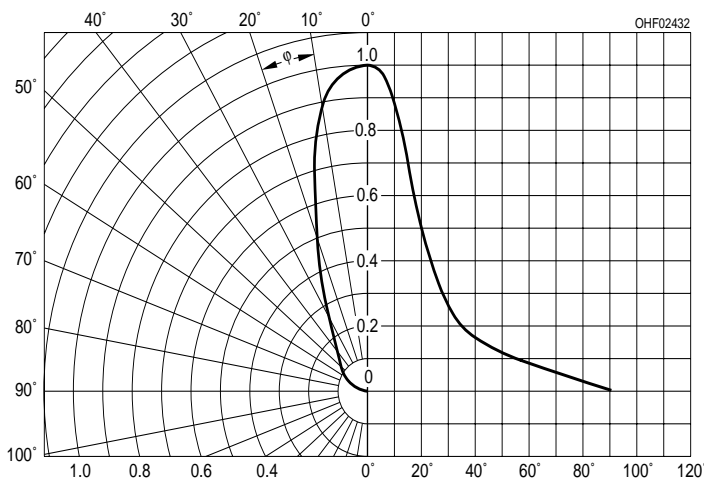

¹⁾ mounted on PC board FR 4 (pad size $\geq 16\ \text{mm}^2$)

Maßzeichnung
Package Outlines

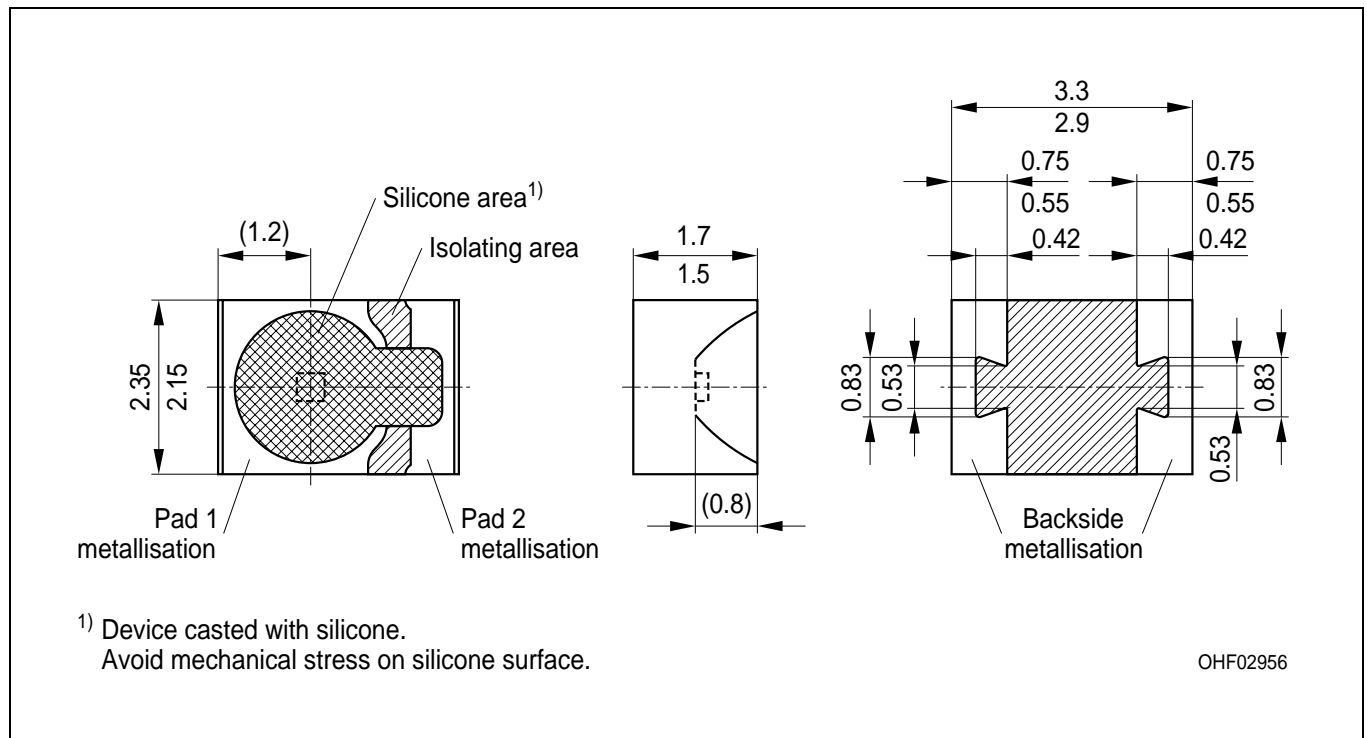

Maße werden in mm angegeben. Dimensions are specified in mm.

Gehäuse package	MID mit klarem Silikonverguss MID casted with clear Silicone
Anschlussbelegung Pin configuration	Pad 1 = Anode/ anode Pad 2 = Kathode / cathode

Empfohlenes Lötpaddesign
Recommended Solderpad Design

SFH 4650

Bauteil positioniert
Component location on pad

Padgeometrie für verbesserte Wärmeableitung
 Pad design for improved heat dissipation

Cu-Fläche > 16 mm²
 Cu-area

Lötstopplack
 Solder resist

OHF02422

SFH 4655

Bauteil positioniert
Component location on pad

Padgeometrie für verbesserte Wärmeableitung
 Pad design for improved heat dissipation

Cu-Fläche > 16 mm²
 Cu-area

Lötstopplack
 Solder resist

OHF02421

Lötbedingungen**Soldering Conditions****IR-Reflow Lötprofil für bleifreies Löten****IR Reflow Soldering Profile for lead free soldering**

Vorbehandlung nach JEDEC Level 2

Preconditioning acc. to JEDEC Level 2

(nach J-STD-020B)

(acc. to J-STD-020B)

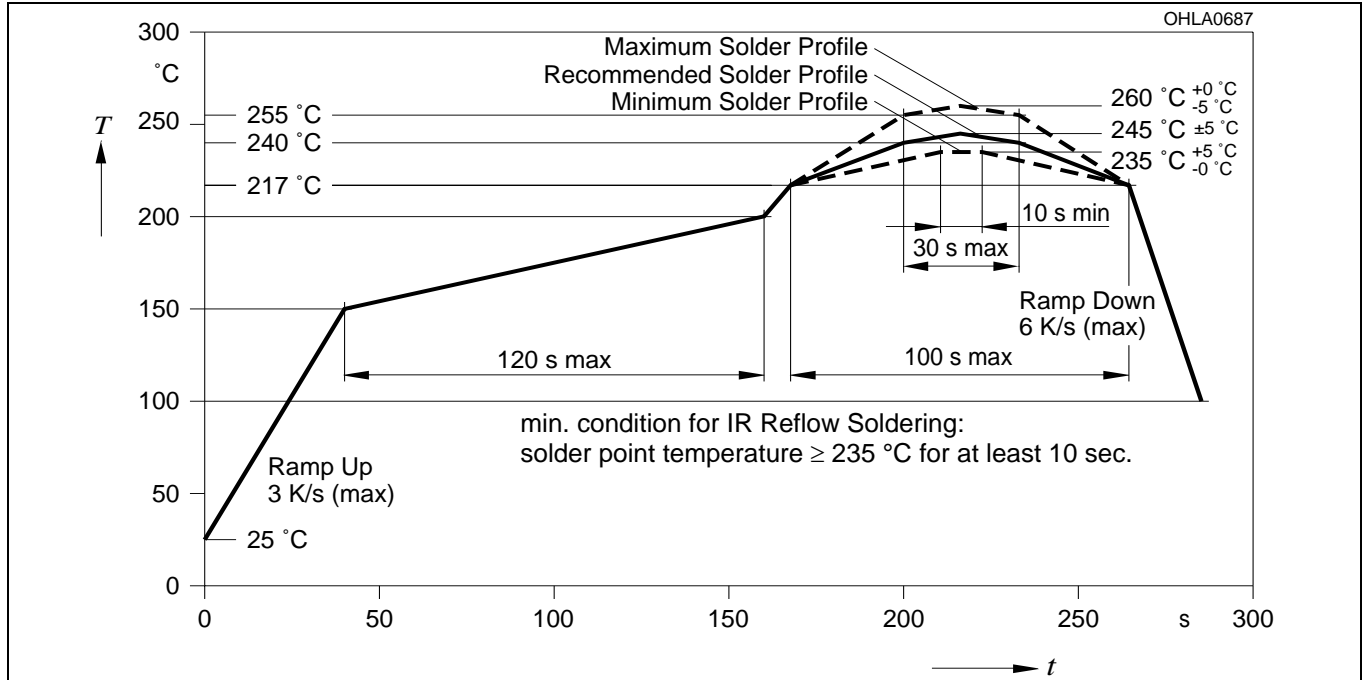

Verarbeitungshinweis: Das Gehäuse ist mit Silikon vergossen. Mechanischer Streß auf der Bauteiloberfläche sollte so gering wie möglich gehalten werden.

Handling indication: The package is casted with silicone. Mechanical stress at the surface of the unit should be as low as possible.

Published by
OSRAM Opto Semiconductors GmbH
Wernerwerkstrasse 2, D-93049 Regensburg

www.osram-os.com

© All Rights Reserved.

The information describes the type of component and shall not be considered as assured characteristics. Terms of delivery and rights to change design reserved. Due to technical requirements components may contain dangerous substances. For information on the types in question please contact our Sales Organization.

Packing

Please use the recycling operators known to you. We can also help you – get in touch with your nearest sales office. By agreement we will take packing material back, if it is sorted. You must bear the costs of transport. For packing material that is returned to us unsorted or which we are not obliged to accept, we shall have to invoice you for any costs incurred.

Components used in life-support devices or systems must be expressly authorized for such purpose! Critical components ¹ may only be used in life-support devices or systems ² with the express written approval of OSRAM OS.

¹ A critical component is a component used in a life-support device or system whose failure can reasonably be expected to cause the failure of that life-support device or system, or to affect its safety or effectiveness of that device or system.

² Life support devices or systems are intended (a) to be implanted in the human body, or (b) to support and/or maintain and sustain human life. If they fail, it is reasonable to assume that the health of the user may be endangered.