

Si PIN photodiode Plastic package

Available with 60 MHz to 500 MHz response speeds

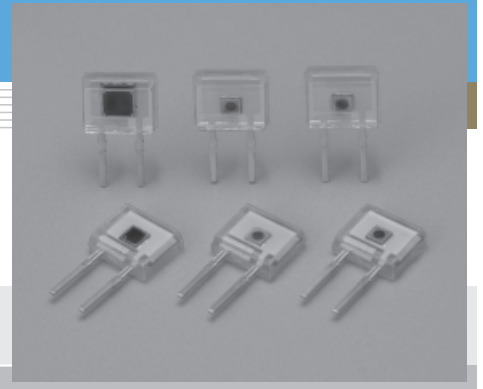

Hamamatsu provides various types of Si PIN photodiodes molded into clear plastic packages. These photodiodes are available with cut-off frequencies from 60 MHz to 500 MHz, allowing you to make the selection that best suits your application. S8387 offers high sensitivity in the violet region and is suited for violet laser detection.

Features

- Clear plastic package (4 × 4.8 mm)
- 2-pin lead style (lead length: 4.9 mm)
- Choice of cut-off frequencies

Applications

- Laser diode front monitors (high-speed APC) for optical disk drives
- Red laser diode (650 nm) and near IR laser diode (780 nm) sensors
- Violet laser detection (S8387)

■ General ratings / Absolute maximum ratings

Type No.	Dimensional outline	Package	Active area size (mm)	Effective active area (mm ²)	Absolute maximum ratings			
					Reverse voltage VR Max. (V)	Power dissipation P (mW)	Operating temperature Topr (°C)	Storage temperature Tstg (°C)
S7329-01	①	Plastic	2 × 2	4	20	50	-25 to +85	-40 to +100
S7836	②		1.1 × 1.1	1.2				
S3321-04			φ0.8	0.5				
S8223								
S8314								
S7762								
S8387								

■ Electrical and optical characteristics (Typ. Ta=25 °C, unless otherwise noted)

Type No.	Spectral response range λ (nm)	Peak sensitivity wavelength λp (nm)	Photo sensitivity S (A/W)				Short circuit current Isc 100 lx (μA)		Dark current Id Max. (nA)	Temp. coefficient of Id TCID (times/°C)	Cut-off frequency fc λ=780 nm RL=50 Ω, -3dB (MHz)	Terminal capacitance Ct f=1 MHz (pF)	NEP λ=λp (W/Hz ^{1/2})		
			410 nm	660 nm	780 nm	830 nm	Min.	Typ.							
S7329-01	320 to 1060	900	0.19	0.45	0.55	0.6	3.3	4.2	1 *1	1.15	60 *1	12 *1	4.8 × 10 ⁻¹⁵ *1		
S7836				0.39	0.48	0.5	1.3	1.65							
S3321-04				0.2	0.39	0.45	0.45	0.37						0.5	0.3 *1
S8223															
S8314	320 to 1000	760	0.27	0.48	0.5	0.45	0.37	0.5	0.3 *2	1.15	500 *2	6 *2	1.4 × 10 ⁻¹⁵ *2		
S7762				1.6 × 10 ⁻¹⁵ *2											
S8387															

*1: VR=5 V

*2: VR=2.5 V

■ Spectral response (1)

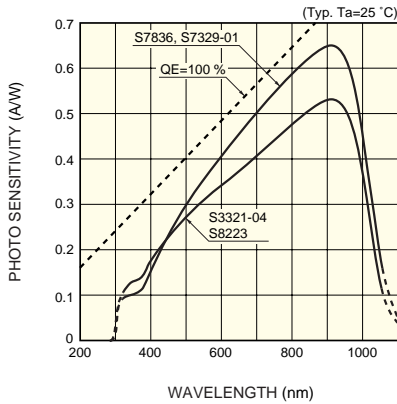

■ Spectral response (2)

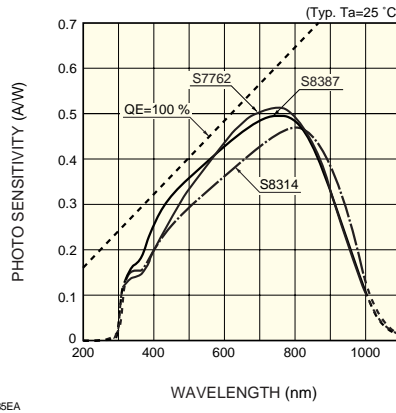

■ Dark current vs. reverse voltage

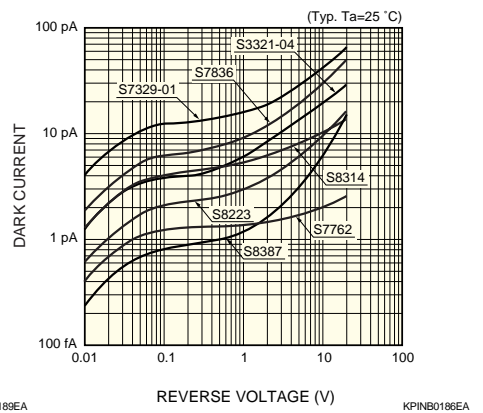

■ Cut-off frequency vs. reverse voltage ■ Terminal capacitance vs. reverse voltage

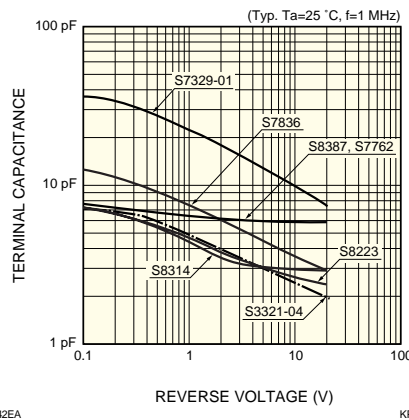
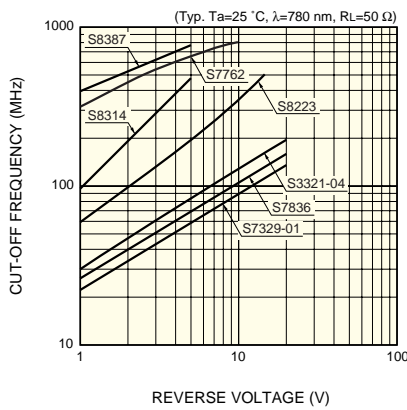

■ Dimensional outlines (unit: mm, tolerance unless otherwise noted: ±0.1)

① S7329-01

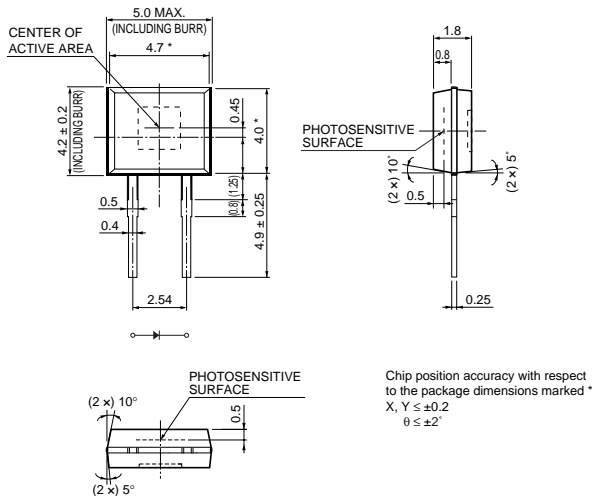

② S7836, S3321-04, S8223, S8314, S7762, S8387

