

TOSHIBA PHOTOTRANSISTOR SILICON NPN EPITAXIAL PLANAR

TPS604

PHOTO TRANSISTOR FOR PHOTO SENSOR

Unit in mm

PHOTOELECTRIC COUNTER

VARIOUS KINDS OF READERS

POSITION DETECTION

- TO-18 metal package
- High sensitivity.
- Sharp directivity. Incident light can be effectively used.
: $\theta_{\frac{1}{2}} = \pm 10^\circ$ (Typ.)
- Countermeasure against disturbance light, improvement of response speed and enable operation can be taken by use of the base pin. Avoid the use of TPS604 with the base pin kept open.
- The same size TPS601A with the base pin is available.

MAXIMUM RATINGS (Ta = 25°C)

CHARACTERISTIC	SYMBOL	RATING	UNIT
Collector-Emitter Voltage	V _{CEO}	40	V
Collector-Base Voltage	V _{CBO}	50	V
Emitter-Base Voltage	V _{EBO}	5	V
Emitter-Collector Voltage	V _{ECO}	5	V
Collector Current	I _C	50	mA
Collector Power Dissipation	P _C	150	mW
Collector Power Dissipation Derating (Ta > 25°C)	$\Delta P_C / ^\circ C$	-1.2	mW / °C
Operating Temperature Range	T _{opr}	-40~125	°C
Storage Temperature Range	T _{stg}	-55~150	°C

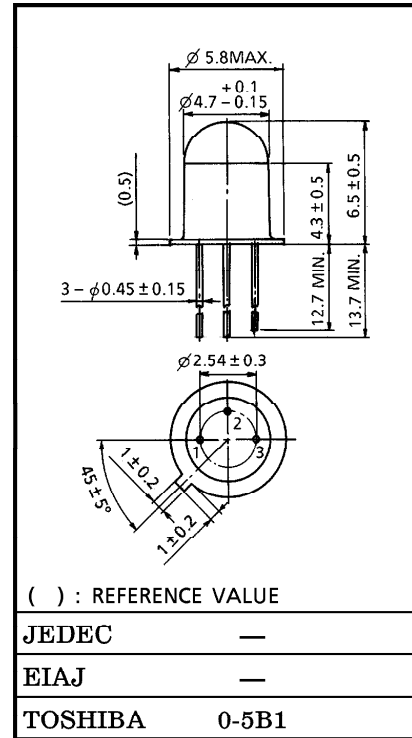

Weight : 0.37g (Typ.)

PIN CONNECTION

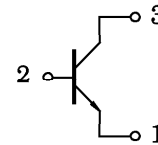

1. EMITTER
2. BASE
3. COLLECTOR (CASE)

PRODUCT INDICATION

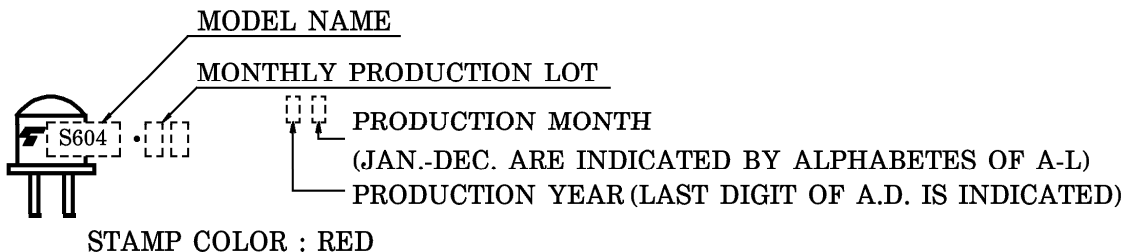

961001EAA2

- TOSHIBA is continually working to improve the quality and the reliability of its products. Nevertheless, semiconductor devices in general can malfunction or fail due to their inherent electrical sensitivity and vulnerability to physical stress. It is the responsibility of the buyer, when utilizing TOSHIBA products, to observe standards of safety, and to avoid situations in which a malfunction or failure of a TOSHIBA product could cause loss of human life, bodily injury or damage to property. In developing your designs, please ensure that TOSHIBA products are used within specified operating ranges as set forth in the most recent products specifications. Also, please keep in mind the precautions and conditions set forth in the TOSHIBA Semiconductor Reliability Handbook.
- The information contained herein is presented only as a guide for the applications of our products. No responsibility is assumed by TOSHIBA CORPORATION for any infringements of intellectual property or other rights of the third parties which may result from its use. No license is granted by implication or otherwise under any intellectual property or other rights of TOSHIBA CORPORATION or others.
- The information contained herein is subject to change without notice.

OPTO-ELECTRICAL CHARACTERISTICS (Ta = 25°C)

CHARACTERISTIC		SYMBOL	TEST CONDITION	MIN.	TYP.	MAX.	UNIT
Dark Current		$I_D (I_{CEO})$	$V_{CE} = 30V, E = 0$	—	0.01	0.2	μA
Light Current		I_L	$V_{CE} = 3V, E = 0.1mW/cm^2$ (Note)	60	200	—	μA
Collector-Emitter Saturation Voltage		$V_{CE (sat)}$	$I_C = 30\mu A, E = 0.1mW/cm^2$ (Note)	—	0.25	0.4	V
Switching Time	Rise Time	t_r	$V_{CC} = 10V, I_C = 10mA$ $R_L = 100\Omega$	—	2	—	μs
	Fall Time	t_f		—	2	—	
Peak Sensitivity Wavelength		λ_P	—	—	800	—	nm
Half Value Angle		$\theta_{\frac{1}{2}}$	—	—	± 10	—	°

Note : Color temperature = 2870°K, Standard Tungsten Lamp

PRECAUTION

Please be careful of the followings.

- Soldering temperature : 260°C MAX.
Soldering time : 5s MAX.
(Soldering portion of lead : above 1.5mm from the body of the device)
- If the lead is formed, the lead should be formed at a distance of 2mm from the body of the device.
Soldering shall be performed after lead forming.

Fig.1 SWITCHING TIME TEST CIRCUIT

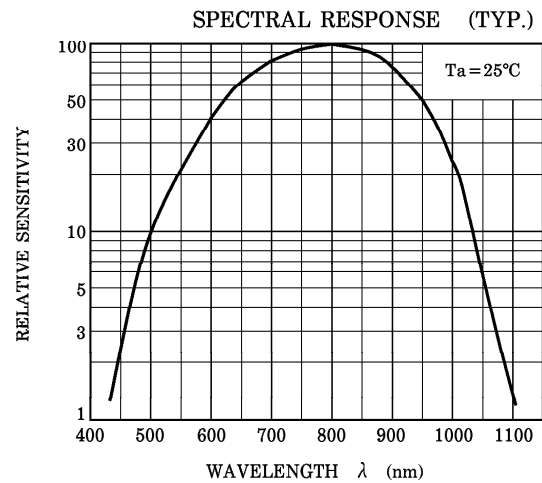
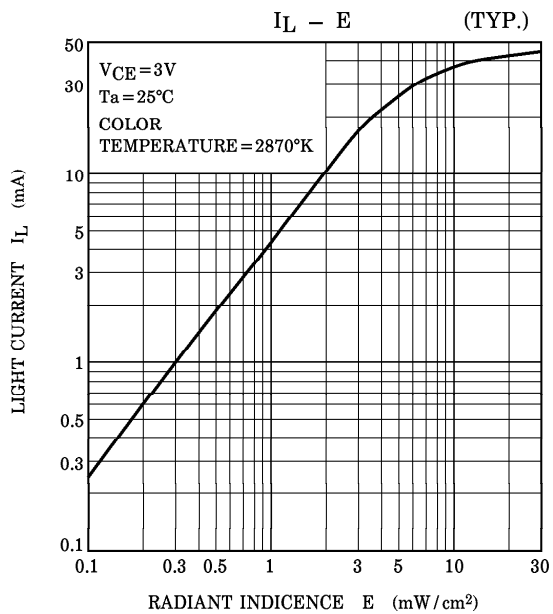
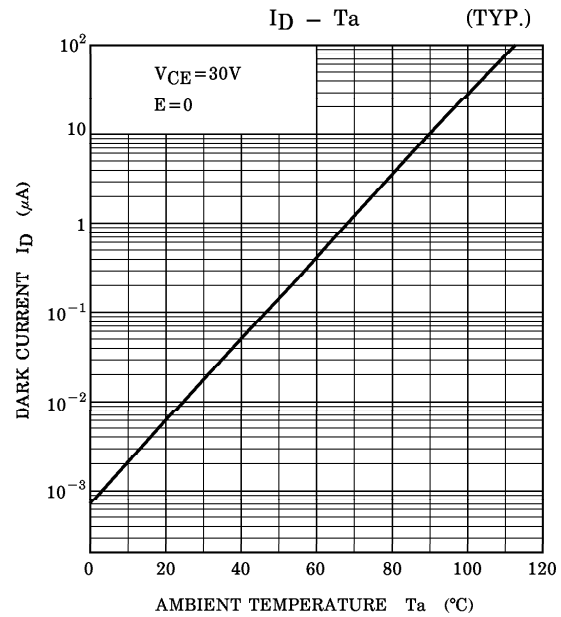
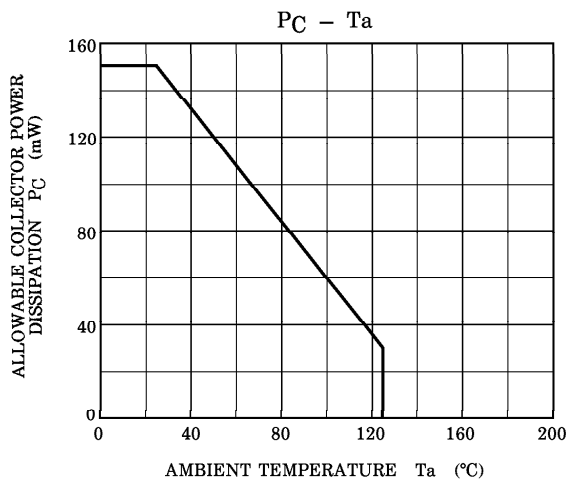
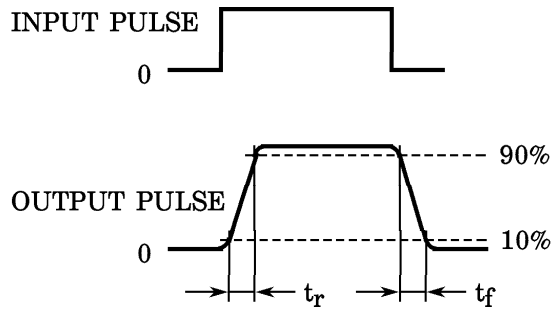
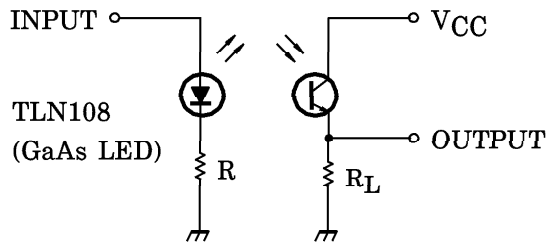

指向感度特性 (標準値)
($T_a = 25^\circ\text{C}$)

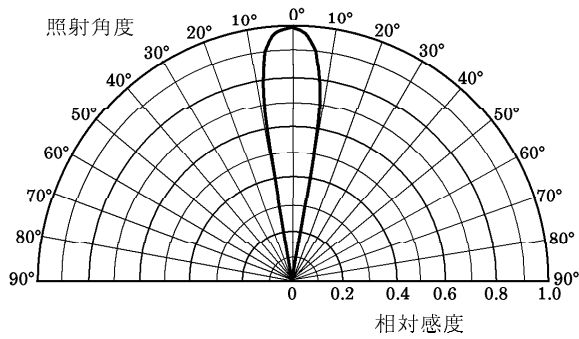

周波数特性 (標準値)

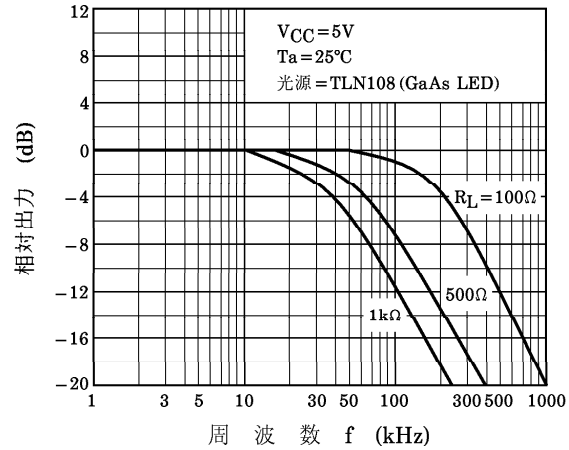

スイッチング特性 (標準値)

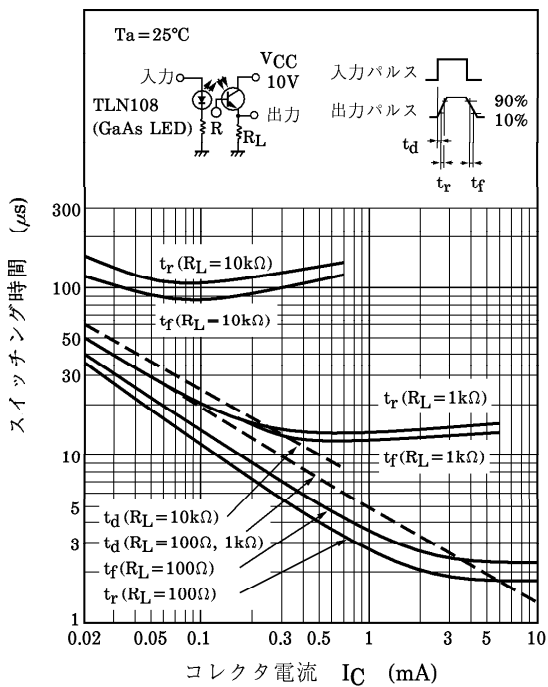

TLN108との結合特性

